

# CITY MULTI FULL PRODUCT LINEUP CATALOGUE 2016



CITY MULTI SERIE



HEATING SERIE



VENTILATION SERIE



CONTROL SYSTEMS SERIE



# Mitsubishi Electric in the world



Founded in 1921, **Mitsubishi Electric** is now a global reality with a consolidated net turnover of 39.3 billion US\$\*, a network of sites in 34 countries worldwide and a workforce of over 124,000. But numbers aside, Mitsubishi Electric – from the Japanese “mitsu bishi”, meaning “three diamonds” – has always been **synonymous with quality**.



The undisputed leader in the manufacture, marketing and sale of electric and electronic devices and equipment, in its over 90 years of history Mitsubishi Electric has supplied high technology, extraordinarily reliable products to major companies and private consumers alike all over the globe. Mitsubishi Electric products and components are used in a huge variety of different applications: IT and telecommunications, space research and satellite communications, consumer electronics, and technology for industrial, energy, transport and construction applications.

Mitsubishi Electric has had operations in Europe since 1969, and now **has sites in 15 European countries**: Czech Republic, France, Germany, Netherlands, Italy, Ireland, Belgium, Poland, Portugal, Russia, Spain, Sweden, UK, Turkey and Hungary. The group's European operations also include 6 production plants (France, UK, Netherlands and Czech Republic) and 2 research and development centres (France and UK).

Established in 1985, **Mitsubishi Electric's Italian subsidiary** operates through four commercial divisions: Air Conditioning (air conditioners for residential, commercial and industrial applications); Factory Automation (devices and systems for industrial automation); Semiconductors (electronic componentry) and Automotive (control systems and components for automobile and motorcycle systems). In particular, the Air Conditioning division handles products manufactured in the group's 5 production plants in Japan, which were joined in 1993 by the factories in Livingston (Scotland) and Bangkok (Thailand).

Improving energy efficiency and comfort is the primary goal of **Mitsubishi Electric**, a company that has always been committed to developing environmentally sustainable, forward-looking technological solutions. For Mitsubishi Electric, constant research into solutions catering for the health and comfort of the user goes hand in hand with environmental awareness. Through continuous investments in research and development, the company has developed pioneering products and systems which substantially reduce energy consumption, operating costs and CO2 emissions. Mitsubishi Electric develops complete solutions for every possible application: from autonomous and centralised residential systems to hotels, restaurants and health spas, and from small condominiums and residential complexes to museums, banks, offices, etc. Mitsubishi Electric offers a comprehensive range of air conditioners for residential and commercial applications with DC Inverter technology, in Mono and Multisplit configurations (for wall-mounted, floor standing, cassette ceiling or ducted installations) for 2 to 8 rooms. We also offer air conditioning systems for medium-sized to large factories and for tertiary sector applications. With its innovative hydronic heat pumps, Mitsubishi Electric brings its proven know-how in the air conditioning sector to the heating market, offering integrated green solutions catering for every possible need. And to ensure the perfect climate for health and wellbeing in every possible space, the Japanese company has also developed an extensive range of outdoor air treatment products to renew air, restore correct oxygen levels and contribute to controlling temperature and humidity. For Mitsubishi Electric, creating the perfect climate for health and comfort means ensuring the ideal air quality with impeccable solutions.

\* at an exchange rate of 103 Yen per 1 US\$ listed by the Tokyo Foreign Exchange Market on 31/03/2014.

# Mitsubishi Electric

## new products and features for 2016

### RMI – Remote Monitoring Interface



The RMI system lets you control your air conditioning, heating and domestic hot water production system remotely from a smartphone, tablet or PC. The system may be used to monitor the performance of your appliances, programme functions, check consumption and view operating states to optimise the efficiency of the system.

### Small Y Series outdoor units



**CITY MULTI 2.0.** The new SMALL Y series of CITY MULTI VRF outdoor units offers best in class energy efficiency. Outstanding performance, connectability to DESIGN indoor units, state of the art VRF technology and heating hot water production capability: these are just some of the advantages of the new PUMY.

- Connectable to residential series DESIGN indoor units using the LEV KIT.
- Mixed indoor unit configuration (VRF and RAC).
- Increased geometric limits for piping.
- 7 sizes available: **4.5HP**, **5HP**, **6HP** (offered as single-phase and three-phase models), and **8HP** three-phase.
- May be connected to up to 12 indoor units.
- 200% connection with Ecodan ATW hydronic module.
- Technical innovations such as the increased density DX coil, for maximised heat exchange surface area.
-  compatible with RMI.

### YKA Ecostandard Series outdoor units



**CITY MULTI 2.0.** The new CITY MULTI VRF Y range of outdoor units sets new technological standards for the industry. Featuring a new design, compact dimensions and a host of advanced technological features, these units offer outstanding, class-beating efficiency and performance.

- Compact dimensions and single module format up to 20HP.
- New DC Scroll Inverter compressor.
- ETC control: New automatic evaporation temperature control function, increasing energy efficiency by up to 20%.
- New DC inverter fan and flanged duct shroud design reducing power absorption and perceptible noise.
- Broad operating temperature range: -20°C to +52°C.
-  compatible con RMI.

---

## 3DT WEB Server centralized control unit



The new **3D TOUCH Controller** represents the state of the art in control systems by Mitsubishi Electric, which invented the industry's first WEB Server centralized controller, the G-50A, in 2003.

- 10.4" backlit, colour SVGA-LCD touch screen.
- 230 V AC mains power.
- Independent or collective control of 50 groups, for up to 50 units overall, in stand-alone mode.
- Ethernet interface and integrated WEB Server software.
- Direct interfacing with electric power consumption meters (Wattmeter).
- Integrated 2 GB SD memory card for storing system data.
- Power consumption data for billing downloadable via internet connection.
- **RMI READY** compatible with RMI.

---

## ADVANCED Remote Control



New ADVANCED remote control unit with large monochrome LCD touch screen with white backlight. New energy saving functions with occupancy, light, temperature and humidity sensors.

- Usable to manage 1 group of up to 16 indoor units.
- Integrated temperature, humidity, occupancy and light sensors.
- SMART energy saving and comfort functions.
- Contextual colour LED indicating operating status of indoor units (heat, cool, error, etc.).
- Temperature settable and viewable with a precision of 0.5°C.
- Internal weekly timer.
- New functions for use in conjunction with AHC Programmable Controller (PLC M-Net), for creating operating strategies with generic devices.

---

## 4-way cassette type IndoorUnit



New Design. The straight-line shape introduced has resulted in a stylish and modern square design. Its high affinity ensures the ability to blend in seamlessly with any interior. The indoor unit is an ideal match for office or store use. New model P50 has been introduced to expand line-up.

- New size P50.
- Horizontal air flow, 5 vane position patterns and individual settable vane.
- Low noise compare to previous model.
- 3D I-see sensor.
- Compact for simplified installation.

# Mitsubishi Electric for air conditioning

A commitment to research and pioneering technological solutions make Mitsubishi Electric the leading name in air conditioning. Poor air quality in urban environments, sudden changes in the weather and large differences in maximum and minimum temperatures can have a profound effect on the comfort and wellbeing of the individual. Ensuring that air quality, temperature and humidity parameters are kept strictly within an ideal range in the home and in the workplace is extremely important - not merely for perceived comfort but even for the health of the individual. Guaranteeing a better quality of life through the best possible air quality is, in essence, the corporate mission of Mitsubishi Electric, which continuously develops pioneering new technologies to apply in its products to reach this goal.



## CITY MULTI

Direct expansion systems with variable refrigerant flow (VRF) have become an important option as a solution for air conditioning systems.

The innovative VRF CITY MULTI systems by Mitsubishi Electric are increasingly becoming the first choice for designers, installers and end clients alike, due to their superior efficiency and modularity, simple, quick installation and extraordinarily economical operating costs.

With a wide range of outdoor units available in a multitude of sizes and formats, with air or water heat source condensers, with heat pump functionality or simultaneous heating and cooling function with heat recovery, and optimised for nominal or seasonal performance, the perfect solution can be found for any application problem, while in its commitment to the environment, Mitsubishi Electric also offers the exclusive REPLACE MULTI system for replacing old R22 VRF systems.

To provide a complete solution, Mitsubishi Electric also offers a wide range of technologically advanced remote and centralised control systems to allow integrated control and adjustment, with the same superior reliability and innovation as VRF CITY MULTI systems. Using one of the wide choice of controller options available will ensure that the air conditioning system functions both correctly and efficiently, and maximises comfort.



# Mitsubishi Electric for air treatment

Treating outdoor air and ducting it into a building is necessary to restore the correct oxygen levels and remove pollution, and contributes to effectively controlling temperature and humidity.

An air conditioning system with no air renewal system cannot ensure even the most basic requirements for health and comfort, as they do not prevent the proliferation of bacteria and other microorganisms.

Mitsubishi Electric offers a wide choice of extremely compact machines conceived to cater for every possible application and demand for outdoor air treatment capacity, with a family of products covering a broad range of air flow rates from 50 to 15,000 m<sup>3</sup>/h.



The secret behind the unparalleled comfort attainable with the Lossnay heat recovery modules used in Mitsubishi Electric outdoor air treatment products lies in the unique structure of the heat exchange elements, which consist of a membrane in special treated paper that keeps the flow of incoming outdoor air and outgoing exhaust air separate, ensuring that only new

outdoor air is fed to the indoor space. The superior heat and humidity exchange properties and absolute impermeability to air of the special treated paper ensures that there is no cross-flow between the two air flows, and allows these units to reach such extraordinarily high levels of total heat recovery (sensible + latent heat).



# Mitsubishi Electric for heating

Mitsubishi Electric boasts the largest range of heat pump heating solutions available on the market: **Ecodan®** is a new family of hydronic heat pumps for heating, cooling and domestic hot water production using renewable energy. The heat pump transfers heat from the outdoor environment to the indoor space using water as the thermal medium, which means that it offers the same comfort as a conventional combustion heating system. An exclusive temperature control system, which is extremely sophisticated but easy to use, maintains thermal stability while maximising energy efficiency. Furthermore, the extraordinary quietness typical of these units also improves acoustic comfort. **Ecodan®** can cater for any need and application, from autonomous residential installations (with split and packaged systems) all the way up to large installations (with VRF systems), while offering unparalleled design flexibility, comfort and energy efficiency, together with lower energy consumption and zero CO<sub>2</sub> emissions.



ecodan

**Ecodan®** hydronic heat pumps are totally integrable with VRF CITY MULTI systems to respond to any need for air conditioning, heating water production and domestic hot water production.

The **Ecodan®** – Split ATW 55 system consists of a Y / WY series VRF CITY MULTI heat pump outdoor unit and an ATW hydronic module for the production of medium temperature hot water up to 55°C and refrigerated water.

The scalability, flexibility and modularity of the Ecodan® – VRF HWS & ATW system represent the state of the art in Mitsubishi Electric technology. Exclusive two-stage technology is used to produce medium to high temperature hot water (from 30°C to 70°C) with a single producer – the VRF outdoor unit – allowing the system to deliver heating water, cooling water and domestic hot water simultaneously.

The **Ecodan®** – Packaged HWHP (Hot Water Heat Pump) system consists of a monoblock outdoor unit, capable of functioning at outdoor temperatures as low as -20°C, which produces very high volumes of high temperature hot water up to 70°C.





# Mitsubishi Electric for energy efficiency

## The heat pump

Air/air and water/air heat pumps for air conditioning and air/water or water/water heat pumps for heating: all the units of the VRF CITY MULTI systems by Mitsubishi Electric are based on heat pump technology – the most efficient solution available for air conditioning and heating.

### PREVENTING GLOBAL WARMING

Heat pump technology allows Mitsubishi Electric to design air conditioners which match comfort with care for the environment.

The operating principle of the heat pump (in this example, a heating unit with a COP of 5.0) Refrigerant and heat flows

Refrigerant and heat flows

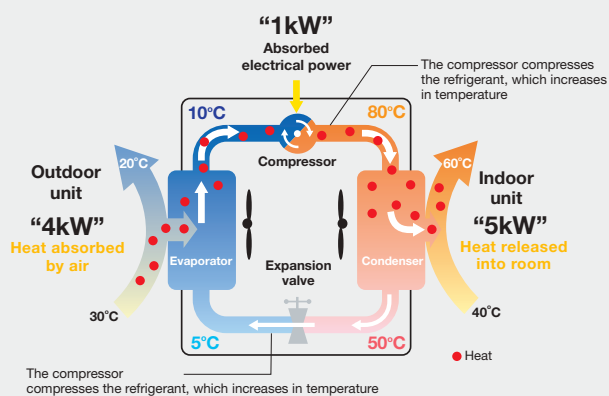

The thermal power delivered to the room is five times greater than the power absorbed from the mains electricity grid

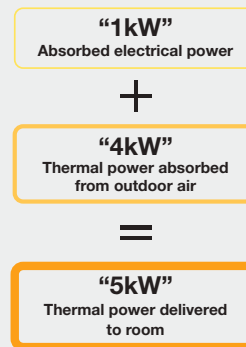

## EER e COP

The energy efficiency of heat pump systems for cooling and heating operation respectively is indicated by the two performance coefficients EER (Energy Efficiency Ratio) and COP (Coefficient Of Performance), which express the ratio between the thermal power delivered and the electrical power absorbed. The higher the ratio, the more efficient the system and, as a result, the lower the consumption.

Mitsubishi Electric VRF CITY MULTI systems have among the highest performance coefficients in their class, as they incorporate the latest technological solutions available as soon as they are developed. These systems are also eligible for government incentives for projects to rationalise energy consumption in buildings and, specifically, for a 50% rebate when used to replace winter air conditioning systems with high efficiency heat pumps.

### EER COOLING

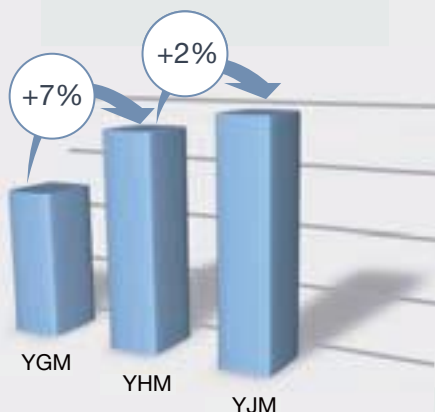

### COP HEATING

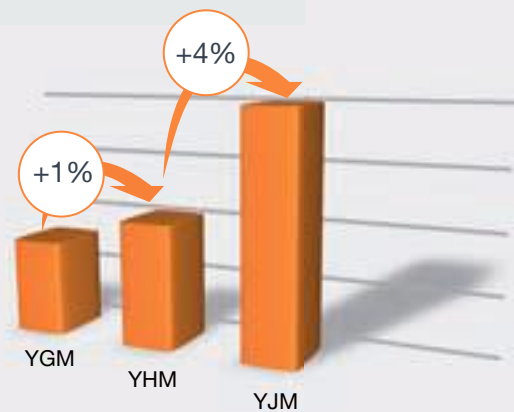

# Mitsubishi Electric for renewable energy

## The heat pump and thermal energy of the air

In response to global warming, the European Union has issued the **RES directive** (Renewable Energy Sources), which defines goals for energy production from renewable sources which each EU member state must attain by 2020. The quota set for Italy, relative to total gross end-user energy consumption, is 17%. Legislative Decree 28/2011 was passed to ensure that the measures necessary to attain this target are implemented in Italy, which introduces the following limits for new buildings and significant renovation projects: the thermal energy production systems must use at least 50% energy from renewable sources for the production of domestic hot water, and also meet the following minimum percentages for renewable energy for heating and cooling:

a) 20%, if the application for the respective building permit is submitted between 31 May 2012 and 31 December 2013;

b) 35%, if the application for the respective building permit is submitted between 1 May 2016 and 31 December 2016;

c) 50%, if the application for the respective building permit is submitted after 1 January 2017.

**As renewable thermal energy sources, heat pumps** contribute significantly to attaining these goals for both heating and cooling applications, as they:

- are 60% more energy efficient than conventional combustion systems and therefore allow buildings to achieve a higher energy classification;
- do not emit CO<sub>2</sub> in the place of installation;
- use renewable energy contained in air.

**PRIMARY ENERGY CONSUMPTION PER 100 kWh THERMAL POWER DELIVERED**

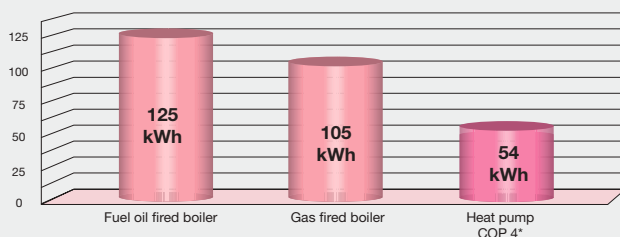

\* Using a power efficiency value of 0.46 for the national thermoelectric power network

**ANNUAL CO<sub>2</sub> EMISSIONS**

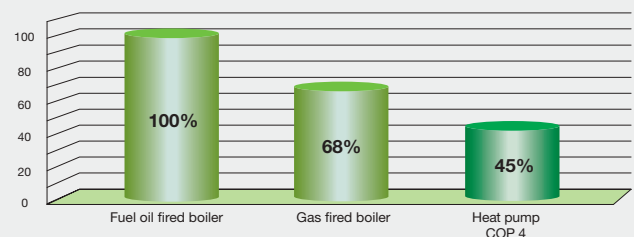

Source: emissions coefficient published by Japanese Ministry of the Environment

## Photovoltaic and solar power

**Photovoltaic panels convert renewable energy radiated by the sun directly into electrical energy.**

Photovoltaic modules not only produce clean energy, but are also manufactured with minimal environmental impact, while the life cycle of these products is subject to stringent monitoring processes. Installing a photovoltaic system therefore:

- offers a means to use clean energy with zero CO<sub>2</sub> emissions;
- significantly reduces electricity bills, if the energy produced is consumed directly;

- allows the building to attain a higher energy class rating during energy certification;
- contributes to achieving the quota for renewable energy sources required by the RES directive mentioned above.

**Integrating the heat pump with photovoltaic panels means that the renewable electric energy generated by the modules is used as efficiently as possible: with both air conditioning and heating powered by solar energy and the thermal energy of the ambient air – both renewable sources.**

# Mitsubishi Electric for comfort

## Air distribution

Correct air distribution prevents stratification, directing treated air towards less easily accessible zones and creating a uniform environment. The ability to change the orientation of the horizontal and vertical vanes from a remote control prevents air flow from being directed at persons.



## Quietness

Mitsubishi Electric equips its air conditioners with every technical solution offered by advanced research to minimise noise. Quietness contributes substantially to the perceived sense of comfort, and has always been a key priority for Mitsubishi Electric.



**80dB(A)** Noise level in a train

**60dB(A)** Inside a quiet passenger car (at 40 Km/h)

**40dB(A)** Inside a library

**20dB(A)** Sound of rustling leaves

**10dB(A)** Limit of human hearing (extremely quiet)

### Silent Mode

This function further reduces the noise produced by the outdoor unit by reducing the maximum fan speed and compressor frequency to comply with night time noise limiting regulations.\*

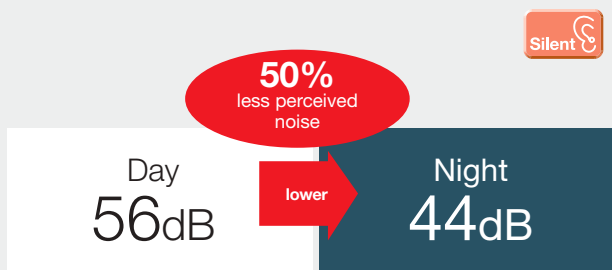

\* In Silent Mode, the thermal and/or cooling capacity of the outdoor unit is limited.

### Standard Mitsubishi Electric indoor units are among the quietest on the market



with indoor sound emissions of just 21dB(A).

### Low turbulence fan

The special profile of the outdoor unit fan blades suppresses turbulence caused by moving air currents, maximising both quietness and efficiency.



# Mitsubishi Electric for comfort

## Functions for optimising the function and efficiency of the VRF CITY MULTI system

### RMI - Remote Monitoring Interface

A new way to define comfort - remotely. The main operating parameters of a VRF CITY MULTI system can now be set and modified remotely from a smartphone, tablet or PC, using dedicated apps for iOS and Android devices. The user can set room temperatures for heating and cooling modes, on/off times, domestic hot water temperature etc. according to weather conditions (using geolocation) and personal preferences.



### Integrated occupancy sensor

The sophisticated occupancy sensor integrated in the new Advanced remote control recognises when the room is occupied on the basis of 2 parameters: movement detected in the room and differences in temperature between the room itself and the persons in the room. The sensor makes it possible to manage the indoor units linked to the controller automatically. This optimises comfort depending on the effective number of people in the room, eliminating waste and maximising energy savings.



### Fresh air quality

The range of Mitsubishi Electric VRF CITY MULTI systems offers the best possible air quality in complete compliance with anti-smoke regulations defined by the Ministry of Health and enforced by specific legislation in all public areas, workplaces and schools in Italy.

Featuring the exclusive LOSSNAY enthalpic heat recovery module, the outdoor air treatment products offered ensure the necessary air exchange for both non-residential environments, as required by the regulation UNI EN 13779, and residential environments. These products also fully meet the requisites for incoming air flow necessary for energy certification, in compliance with the regulation UNI/TS 11300-1:2008.

### Broad operating temperature range

Extended comfort: the new extended temperature range function allows systems supporting the function to be set with maximum setpoints up to 35°C in cooling mode, and minimum setpoints as low as 4.5°C in heating mode.

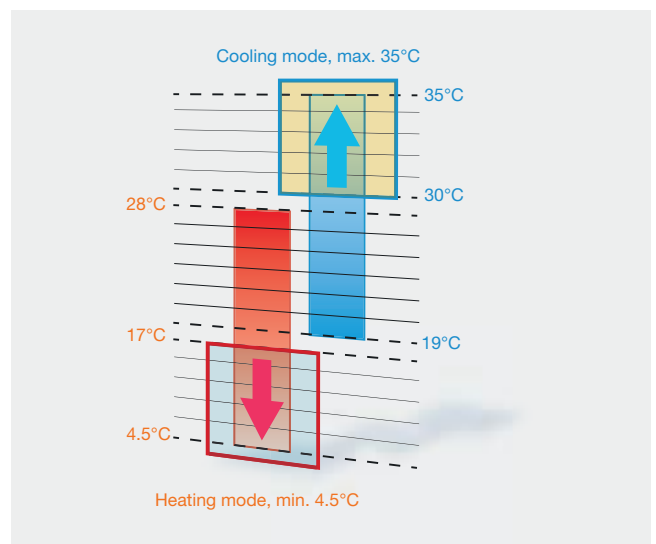

# Mitsubishi Electric for design

## Design and comfort

With Mitsubishi Electric, comfort and energy efficiency come together with design, in elegant products that are easy to integrate into any type of interior, and designed and built to deliver unparalleled performance with total respect for the environment.

### 3D TOUCH Controller - WEB Server centralised controller



The WEB Server centralised controller combines impressive processing power, which makes it the first and only controller to display a graphic representation of the layout of the system, with impeccable design, with modern, square lines and a polished glass-effect front panel.



**Alasplit** is an innovative automated device which caters for the cosmetic needs of air conditioning systems installed in a home, office or store. This innovative system brings an end to unsightly grey cover grilles and permanently visible air conditioner units.

### ADVANCED Remote Control



The new **ADVANCED remote control** by Mitsubishi Electric boasts an impeccable design with square, modern lines and a glass-effect polished front panel. With sophisticated looks and impressive versatility, this remote control is intuitive to use, pleasant to look at and a pleasure to show off. **The new remote control** has a large monochromatic LCD touch screen display with white backlighting that is clearly legible in all conditions and from any angle.

# Mitsubishi Electric for **the environment**

## “Technology & Action”

contributing positively to protect planet Earth and its population.

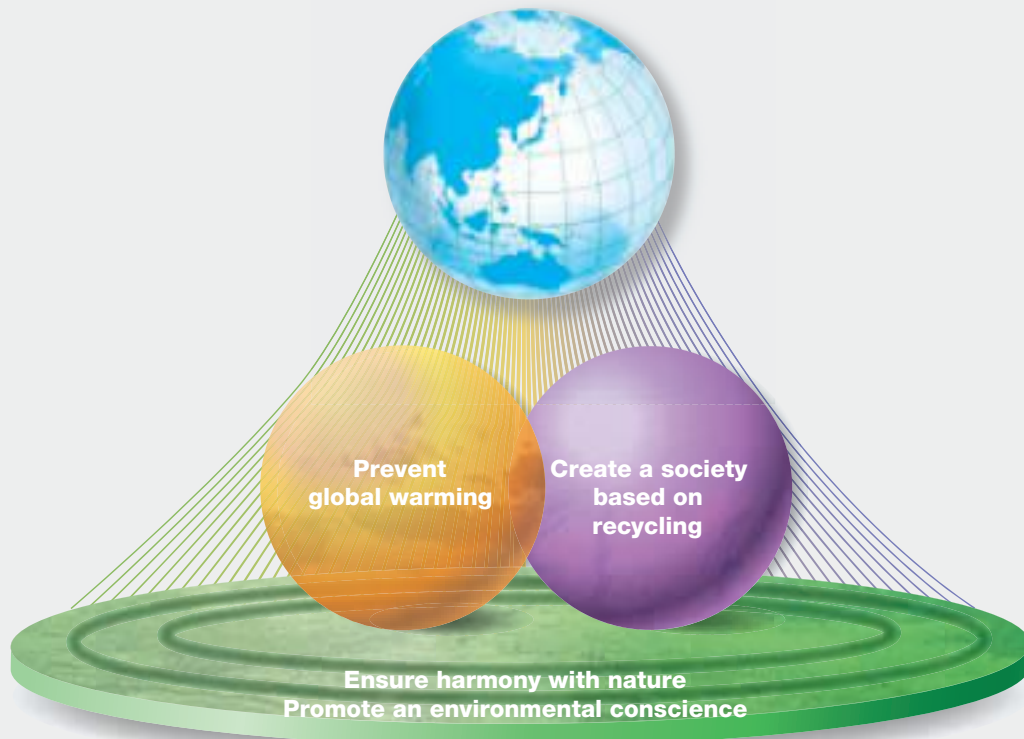

for a greener tomorrow

### **Mitsubishi Electric** **Environmental Vision 2021**

Environmental Vision 2021 is Mitsubishi Electric's long term environmental management programme aiming to achieve significant and specific environmental goals by 2021 – the centenary of the foundation of the company. The programme is based on the principle “Technology & Action”, and is intended to contribute positively to protecting the Earth and its population. The goals of this programme are:

- Prevent global warming
- Create a society based on recycling
- Ensure harmony with nature
- Promote an environmental conscience

### **Eco Changes**

This far-reaching environmental vision also introduces Mitsubishi Electric's new motto for the environment: Eco Changes – for a greener tomorrow. In keeping with the Mitsubishi Electric company motto “Changes for the better”, which embodies the group's continuous commitment to researching and putting improvements into practice, Eco Changes expresses Mitsubishi Electric's dedication to correct environmental management, and conveys the ongoing, extensive efforts of the group towards a greener tomorrow, putting pioneering environmental technologies and superior manufacturing know-how to use to achieve an environmentally sustainable society.

## The global scenario: Accelerating global warming

The increasing levels of carbon dioxide (CO<sub>2</sub>) in the earth's atmosphere are considered one of the main factors causing global warming.

The average temperature of our planet has increased by more than 0.8°C over the past century, causing serious upheavals in the climate. It has been estimated that global temperatures could increase by 1.1°C to 6.4°C by the year 2100.

Fig. 1 Average global temperatures from 700 to 2100 (recorded and forecast values).

Source: "The Fourth Assessment Report" published by the Intergovernmental Panel on Climate Change (IPCC) (<http://www.ipcc.ch/>)



## The global scenario: The largest sources of CO<sub>2</sub> emissions

The increasing levels of carbon dioxide (CO<sub>2</sub>) in the earth's atmosphere are considered one of the main factors causing global warming.

As can be seen in the graph, the energy, transport and civil sectors (residential, tertiary etc.) are among the largest producers of CO<sub>2</sub> emissions in Italy. In particular, the civil sector accounts for 20% of all CO<sub>2</sub> emissions.

With so many people spending time at home or in their workplace, it is no surprise at all that buildings account for such a large percentage of emissions. In buildings, the energy expended on air conditioning (summer and winter) and on hot water production represents the largest percentage of the total primary energy expenditure. In this global scenario, it is clear that more energy efficient buildings and homes offer enormous potential for reducing energy usage, especially if in conjunction with equally high performance air conditioning and hot water production systems.

Mitsubishi Electric plays a crucial role in this sector by offering a host of highly efficient solutions for air conditioning, heating and air treatment.

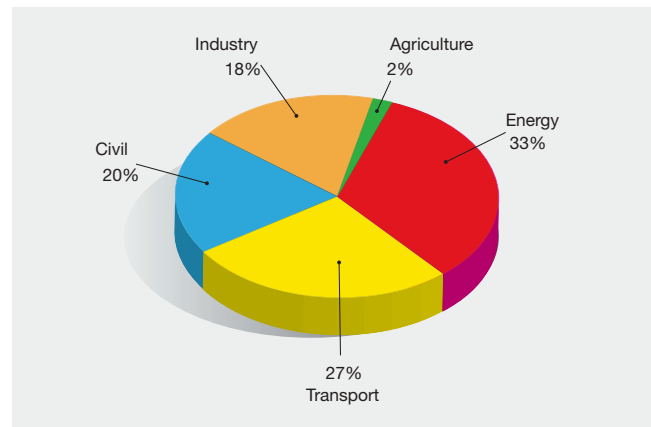

## The replacement of air conditioning systems using R22

The EU regulation 2037/2000/EC has banned the use of virgin HCFC refrigerants (R22) since 1/1/2010. As a result, in the event of a fault or even just a refrigerant leak in an air conditioning system using R22, it is no longer possible to recharge the system.

Mitsubishi Electric's solution for the VRF R22 system replacement market is founded on the 3 Rs: Reuse, Replace and Renew. The innovative Mitsubishi Electric Replace Multi solution makes it possible to reuse components and structural elements of the existing system instead of completely replacing all units and refrigerant pipelines.

Reasons for choosing REPLACE MULTI:

- New generation outdoor units with R410A are much more efficient, with lower electric power consumption.
- Quicker installation times, by minimising the work required on infrastructure, and a smaller financial outlay compared with the existing VRF R22 system.
- Taking advantage of the 50% tax rebate for building renovation projects, or the 65% rebate offered for replacing winter air conditioning systems, will minimise the time necessary to recoup the initial outlay.



# Mitsubishi Electric

## for quality and safety

### Certified quality



**Mitsubishi Electric Quality, or MEQ for short, stands for many things. It is a testimony of 90 years of excellence in technology, design and production.**

**It stands for the highest possible standards for comfort, efficiency and durability. And it is a mark of the best air conditioners money can buy today.**

**A guarantee of the most advanced technology and highest possible quality**, the MEQ logo represents Mitsubishi Electric's pride and commitment to retaining its position as the leader in the air conditioning world.

Our products are the result of painstaking research, rigorous testing and a steadfast dedication to continuous improvement. Offering unparalleled reliability and functionality, our air conditioners ensure indoor ideal air quality and create a comfortable environment in the home or workplace.



Our Lossnay enthalpic heat recovery modules have recently attained certification which guarantees their specified performance.



Air conditioners are subject to safety standards defined by specific European directives.

The CE mark is a guarantee of conformity with these standards, and all the models in the vast range of Mitsubishi Electric air conditioners meet the requisites for carrying this important certification.



**ISO 9001** is synonymous with total quality. This is the most important quality system acknowledgement that a company can aspire to, and is only granted to industrial concerns which, like Mitsubishi Electric, can ensure excellence in every stage of the production cycle, from design to the after-sales service.



**ISO 14001** certification testifies that a company implements specific management systems for its products and/or services which effectively safeguard the environment and the health of citizens.

### Recycling



Mitsubishi Electric has chosen to subscribe to the ReMedia Consortium, a leading collective organisation with the goals of ensuring that consumers handle and recycle WEEE material (Waste Electrical and Electronic Equipment) correctly, and promoting environmental protection policies.

The primary objective of Italian Legislative Decree 151/05 is to protect the environment, in particular, through the implementation of policies and practices to prevent the production of Waste Electrical and Electronic Equipment (WEEE) and to promote the recycling of these materials to reduce the quantity of waste subject to waste treatment.

In particular, consumers will be required to not dispose of WEEE materials as normal urban refuse, and to take active part instead in separate waste collection in accordance with the practices specified by the aforementioned Legislative Decree.





# CITY MULTI VRF Systems Serie

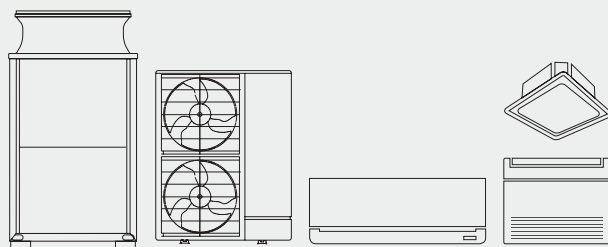

---

## **INDEX**

CITY MULTI Unique, exclusive characteristics .....	<b>18</b>
--	-----------

# Unique, exclusive characteristics

**RMI** Remote Monitoring Interface.

An energy management and monitoring system

## What is RMI?

RMI is an all new cloud computing based system for the remote management, energy monitoring and maintenance of Mitsubishi Electric Air Conditioning solutions from smartphones, tablets and PCs.

RMI may be used to monitor the performance of your appliances, programme functions, check consumption and view operating states to optimise the efficiency of the system.



## Control systems simply and intuitively

Set weekly programmes and special events, and view and analyse the operating parameters of your system remotely from a mobile device with a graphic interface that lets you change settings instantaneously when needed.



## Who can use RMI?

Because of its many different functions, the RMI system is suitable for all types of installation, from centralised **residential** systems to **commercial** applications and **large scale installations**. The remote management and monitoring functions are intended for **end users** (e.g. tenants), **owners**, **administrators**, **energy/building managers**, **global service providers** and **installing and maintenance technicians**.

## Your perfect climate in an App!

Control your air conditioner, adjust temperature and air flow settings, view and manage hot and cold water production status and check for system faults.

All from an app on your smartphone or tablet.



## Manage, view detailed information and analyse

Manage multiple installations with different sizes and architectures conveniently from the application on your PC, view function parameters in a summarised dashboard interface, and analyse specifically created reports to make your installation work even more efficiently. RMI is also the ideal solution for the centralised management and supervision of multiple installations in different locations.



## The choice

**RMI is offered in the following packages:**



Real time remote, mobile control, view active faults, weekly (x2) and annual timer functions, and geolocalised weather function.



Multi-installation management, alarm log, standard monthly reports, standard monthly graphs, fault notification and reset via e-mail and SMS.



Upgrade feature (applicable for ADVANCED packages only) for creating sub-users with customisable functions.

# Unique, exclusive characteristics

**R2 Series:** The world's first and only two-pipe heat recovery VRF system with simultaneous heating and cooling capability

## Comparison between different systems with different pipe connection points

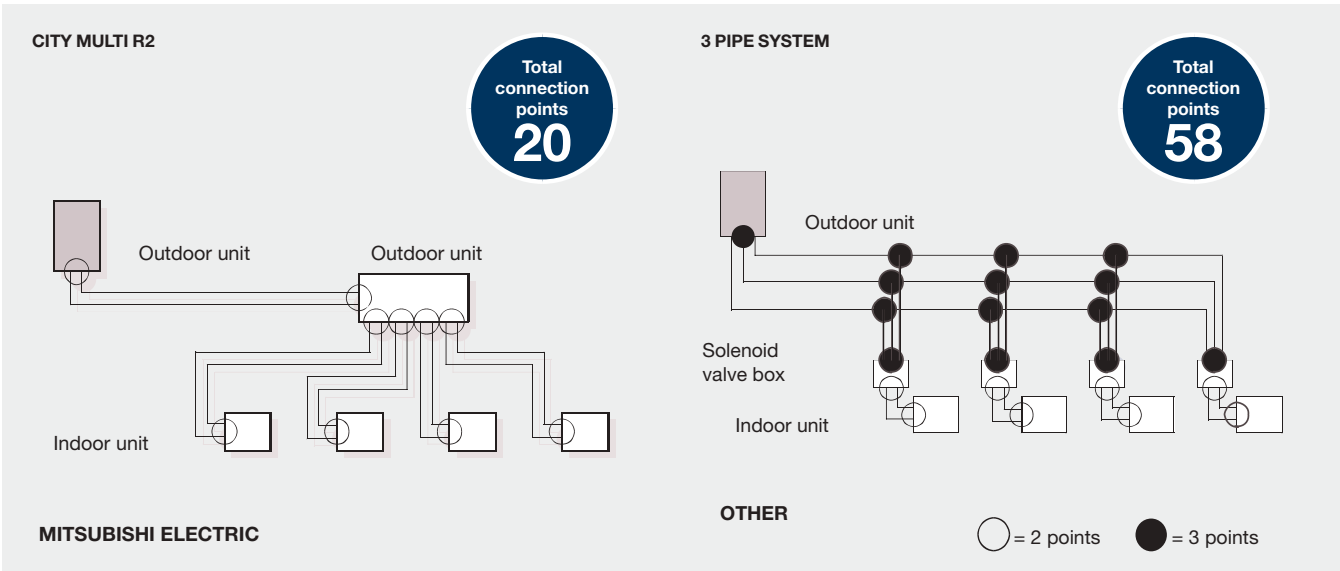

## How does the R2 / WR2 heat recovery system work with two pipes?

The secret of the VRF CITY MULTI heat recovery system lies in the BC controller. The BC controller contains a liquid/gas separator which allows the outdoor unit to produce a two-phase mixture of hot gas for heating and liquid for cooling delivered through the same pipe. Three pipe systems use one pipe for each of these two phases. The mixture is separated when it reaches the BC controller, and the correct phase (gas or liquid) is sent to each indoor unit in relation to individual demand for heating or cooling.

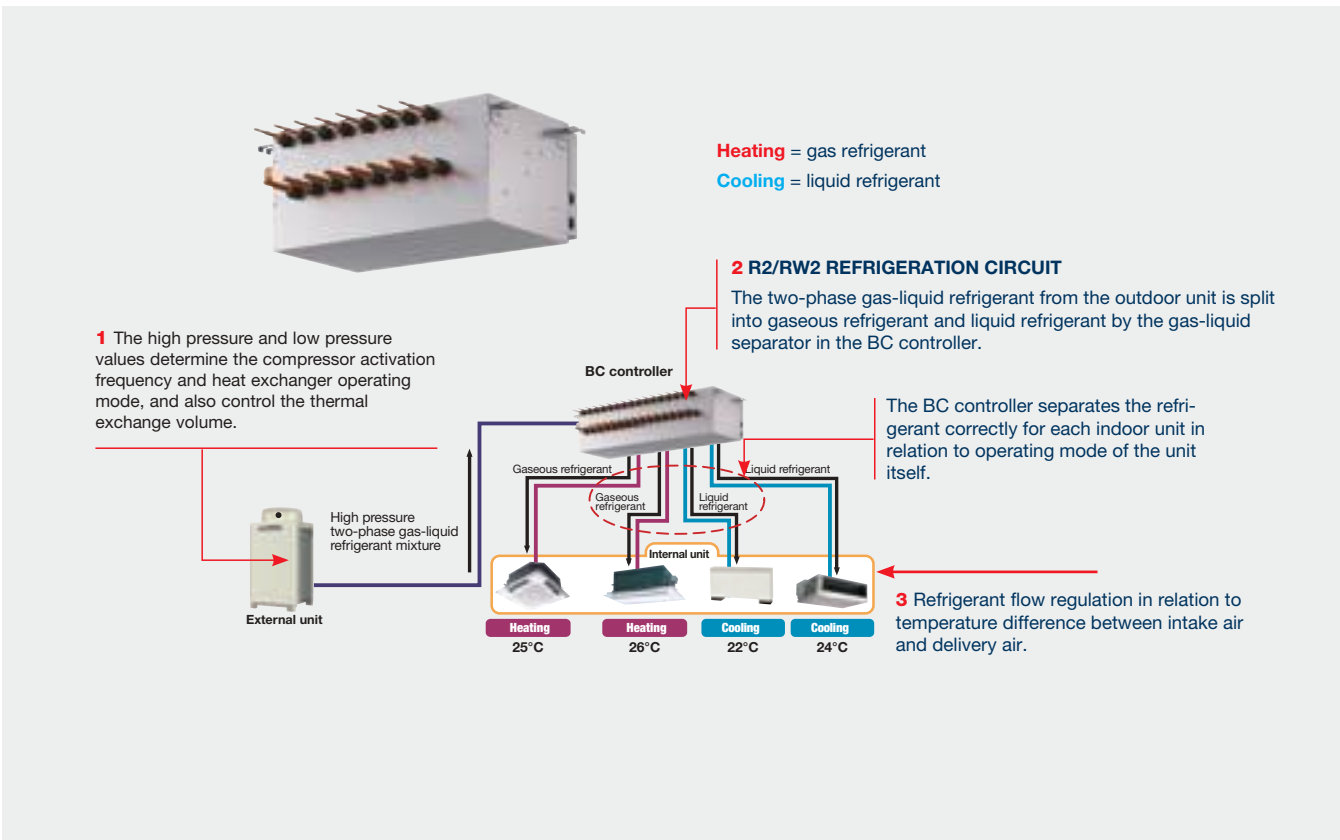

# Unique, exclusive characteristics

**R2 Series:** The world's first and only two-pipe heat recovery VRF system with simultaneous heating and cooling capability

## Heat recovery system

With the heat recovery system, the more often the simultaneous cooling and heating function is used, the greater the energy savings.

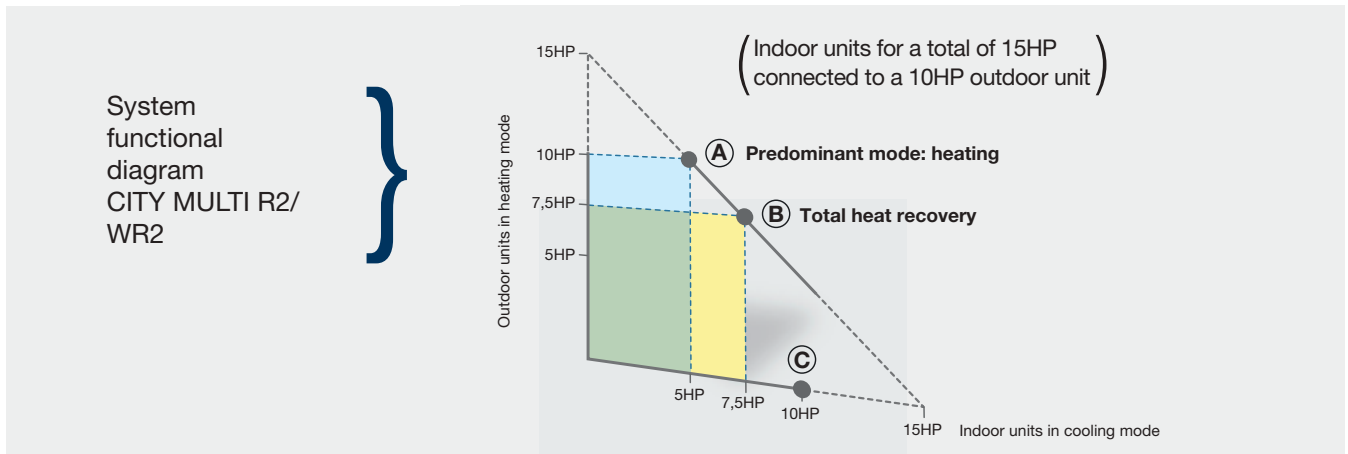

## Why use heat recovery?

Flexibility and efficacy are decisive factors when choosing a system with heat recovery capability. For instance, while a heat pump system is suitable for an office with a large open space plan, in an office space subdivided into more units, a system is needed that can simultaneously heat and cool different zones in accordance with the preferences of each individual user. The efficacy of these systems stems from their ability to use by-products of cooling and heating to transfer energy where it

is needed, therefore functioning as a balanced heat exchanger offering savings of up to 20% in operating costs compared with a conventional heat pump system. Moreover, the number of connection points needed for an R2 / WR2 system is significantly lower than the number required by a three pipe system. This reduces installation costs, further adding to the savings offered by using the VRF CITY MULTI system.

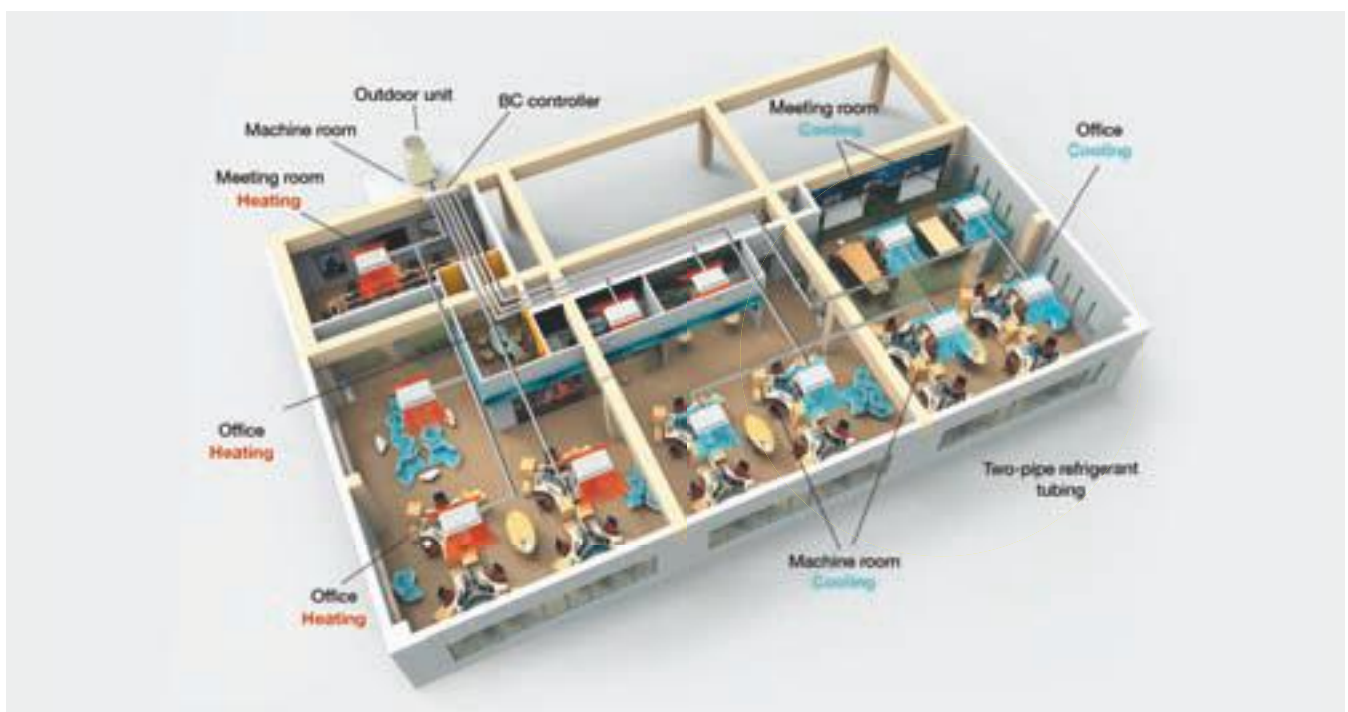

# Unique, exclusive characteristics

**M-Net Power:** Uninterrupted operation system for VRF indoor units

## M-Net Power

With the M-Net transmission line and the use of separate power and control circuits for indoor units, the following states can be identified automatically:

- indoor unit malfunction
- power loss to indoor unit.

In the event of one of these conditions, the outdoor unit isolates the malfunctioning indoor unit or indoor unit receiving no power to ensure the continued electrical and refrigeration functionality of the system with no action required from a technician and/or a system

administrator. This allows total flexibility in planning and laying out 220V AC power circuits, **without the need for shared main lines and without requiring any additional devices to attain compliance with legislation for electrical systems.** This circuit configuration is essential for situations where the system itself is shared by multiple owners or tenants, and where each must be able to electrically isolate their respective indoor terminal sections when required.

## Continuous operation

In the event of power loss or partial malfunction of one or more indoor units, the system continues to function uninterruptedly and without requiring any action from a technician and/or system administrator.

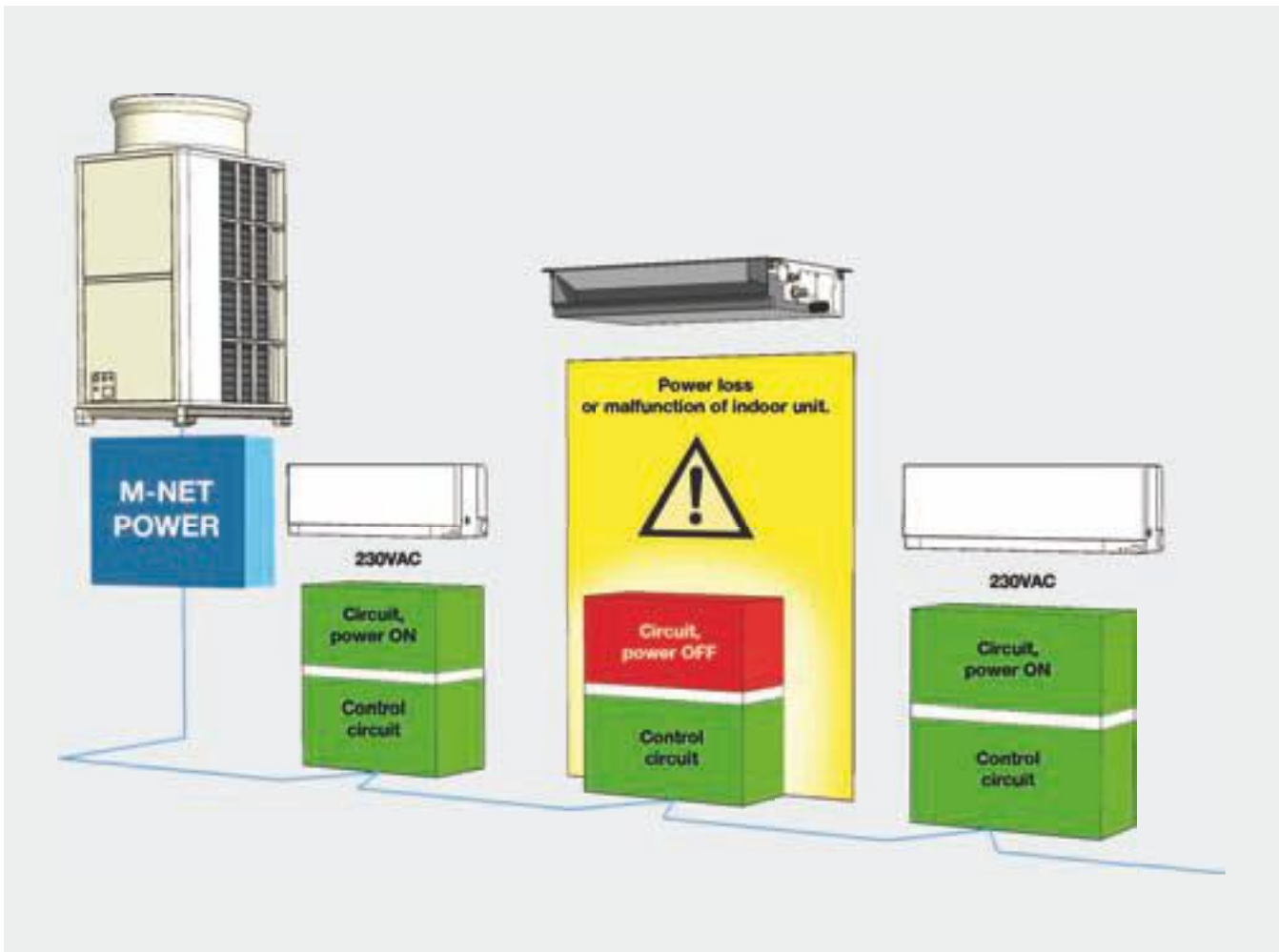

# Unique, exclusive characteristics

200% extended connectivity system

## 200% extended connectivity system

The innovative Ecodan® HWS & ATW unified VRF system by Mitsubishi Electric for cooling, heating and domestic hot water production brings VRF technology to the heating market.

To ensure correct power usage in applications such as centralised residential systems and hotels, where permitted by the coincidence factor, **Mitsubishi Electric offers a system allowing up to 200% extended connectivity.**

The 200% extended connectivity system offers the **advantage of simplified, intuitive and, most importantly, automated operation** comparable to a conventional centralised heating system (e.g. gas boiler), meaning that the professional installer is no longer required to include complicated, redundant management and adjustment systems.

## System architecture

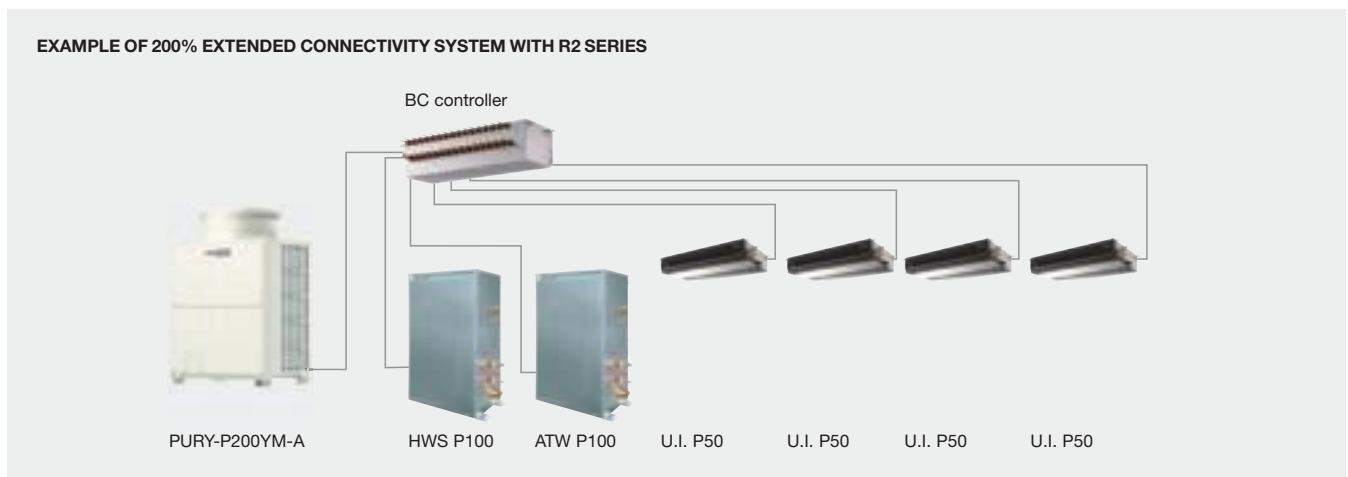

For example, in a hypothetical installation with a P200 outdoor unit, this system permits the connection of units with a total power index equal to 200% that of the outdoor unit (P400), subdivided according to the following rules:

- Maximum power index for hydronic modules = P200 (100% of outdoor unit power index)
- Maximum power index for indoor modules = P200 (100% of outdoor unit power index)

A VRF Ecodan® installation with this configuration will ensure simultaneous operation up to a power index of 130%, in the case of a Y heat pump system, and up to **150%** in the case of an R2 heat recovery simultaneous heating and cooling system.

## The right power for the right application

The 200% extended connectivity system conceived by Mitsubishi Electric is applicable **only** for mixed configurations with simultaneous production functions: Heating with standard VRF indoor units, primary heating function with ATW hydronic modules and domestic hot water production with HWS modules (in this case, only with R2 heat recovery simultaneous cooling and heating systems). This system requires that a precise operating limit is defined that will ensure that the outdoor unit power drawn is appropriate for the ambient loads effectively to be satisfied in all operating conditions and at all times. As a consequence, it is always important to evaluate maximum simultaneous power demand in the different operating modes possible.

### Operation with heat pump systems (Small Y (PUMY) and Y (PUHY))

Application	ATW Hydronic Module	Indoor Units
	Primary Heating	Air Cooling and Heating
WINTER	ON	OFF
AUTUMN/SPRING	OFF	ON
SUMMER	OFF	ON

### Operation with simultaneous cooling and heating heat recovery systems (R2 (PURY))

Application	ATW Hydronic Module	ATW Hydronic Module	Indoor Units
	DHW Production	Primary Heating	Air Cooling and Heating
WINTER	ON (365 days/year)	ON	OFF
AUTUMN/SPRING	ON (365 days/year)	OFF	ON
SUMMER	ON (365 days/year)	OFF	ON



# Unique, exclusive characteristics

**Y Series:** Automatic hot/cold switching function: "Reference group" method

## Functions

This function is activated from a setting made via a centralised WEB Server controller (3D TOUCH Controller, 3D BLIND Controller) or the TG-2000 controller. The selected group is enabled in AUTO mode, and used as the "Reference group".

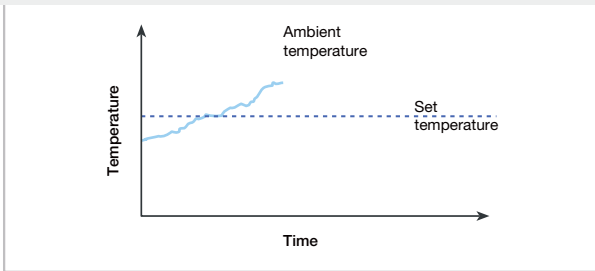
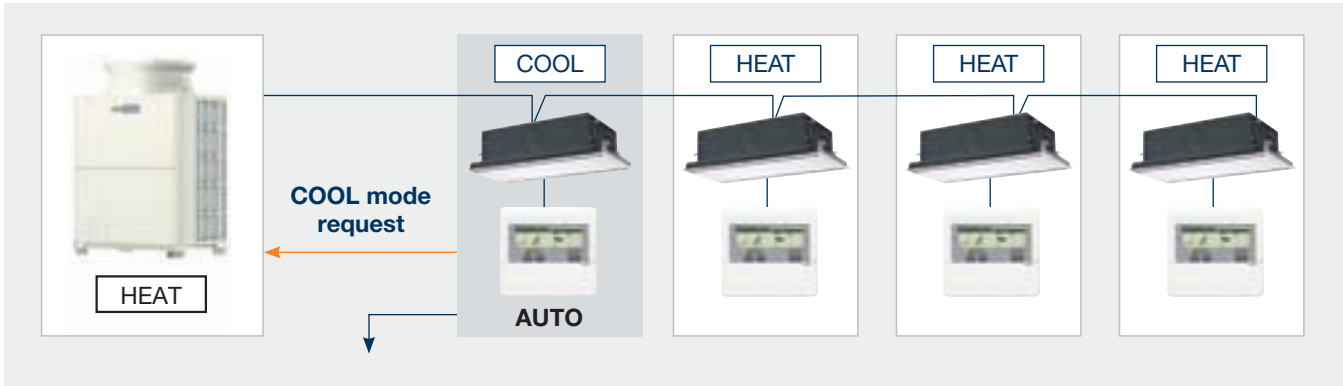

The reference group requests a change in operating MODE for the respective outdoor unit.

**NOTE:**  
HEAT = "Heating" mode  
COOL = "Cooling" mode

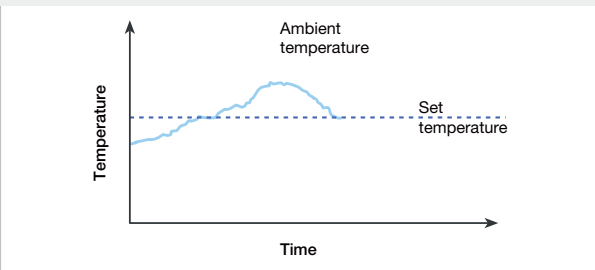
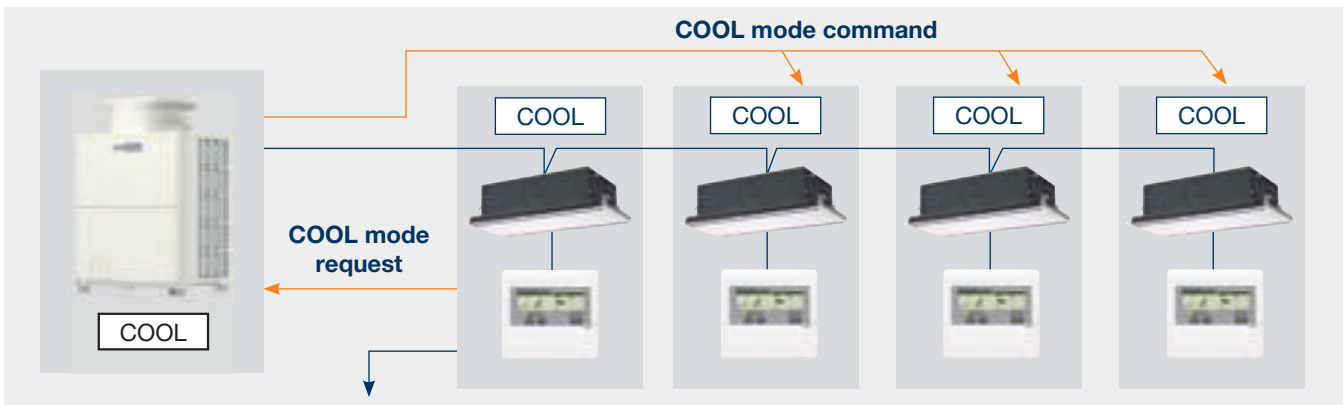

The outdoor unit switches to the required operating MODE, and then transmits the respective information to all connected indoor units.

**NOTE:**  
HEAT = "Heating" mode  
COOL = "Cooling" mode

# Unique, exclusive characteristics

**Y Series:** Automatic hot/cold switching function: "Reference group" method

## Functions

This function is activated from a setting made via a centralised WEB Server controller (3D TOUCH Controller, 3D BLIND Controller) or the TG-2000 controller. The selected group is enabled in AUTO mode, and used as the "Reference group".

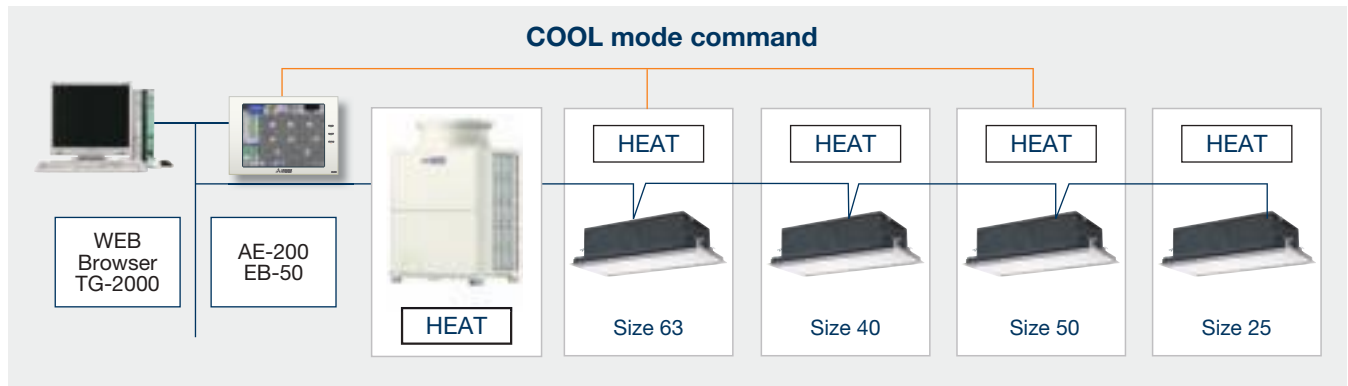

The capacities of the indoor units requiring COOL functionality and those requiring HEAT functionality are calculated from the difference between ambient temperature and set temperature. The operating MODE is switched accordingly for the unit with the greatest capacity.

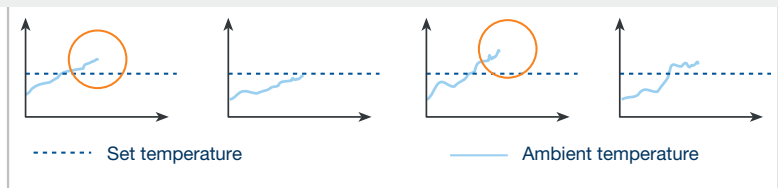

**NOTE:**  
 HEAT = "Heating" mode  
 COOL = "Cooling" mode

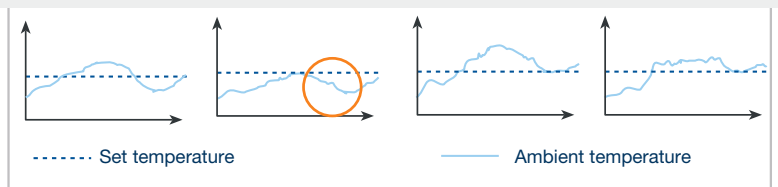
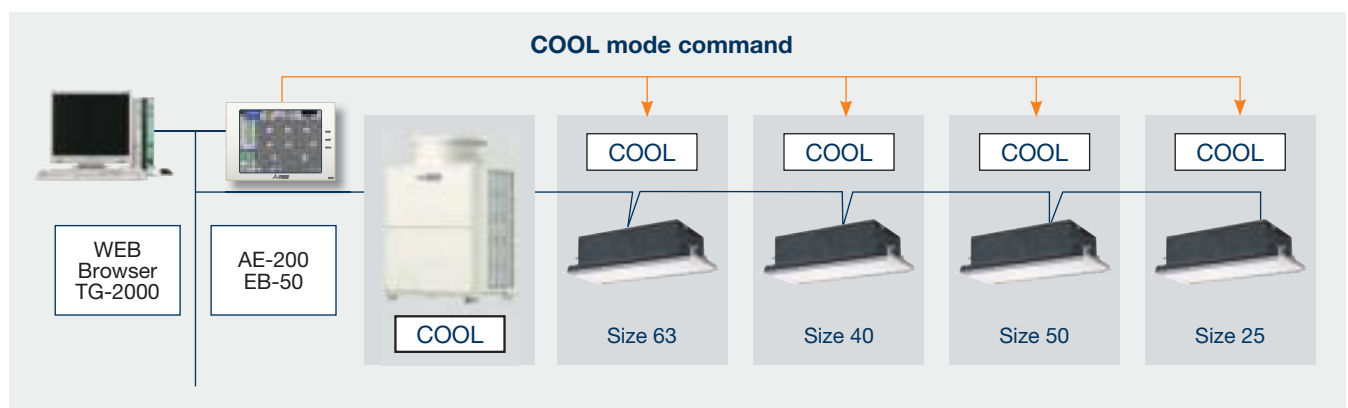

**NOTE:**  
 HEAT = "Heating" mode  
 COOL = "Cooling" mode

# Unique, exclusive characteristics

## Indoor units

### Multi-refrigerant

The indoor units of VRF CITY MULTI systems are the first and only products on the market with multi-refrigerant capability. These units can operate with R22, R407C and R410A systems with no loss in performance, irrespective of the different pipe sizes. This allows unparalleled freedom for installation, as well as offering total reverse compatibility in the event of replacing indoor units with an R22 or R407C VRF CITY MULTI system.

### Extended settable temperature range in cooling mode, with minimum temperature of 14°C

Where the ability to cool to temperatures lower than the standard lowest comfort value of 19°C (typically for sports centres, laboratories etc.) is necessary, the settable temperature range in cooling mode may be extended to offer a lowest temperature of 14°C on the following models:

- Floor-standing
- Built-in floor units
- 2-way cassette
- Ducted

The indoor unit fan is run at a higher speed in this configuration (except with the SMALL Y model outdoor unit of the PUMY series).



### Intelligent Terminal Boards

Intelligent indoor unit terminal boards are a **unique feature** of Mitsubishi Electric VRF systems.

These intelligent terminal boards make it possible to use the air conditioning system and the M-NET communication network, via the indoor units, as a vehicle for collecting, transferring and monitoring field signals from generic appliances such as lighting,

power, access management, intelligent alarm systems etc. Using the intelligent terminal boards of the indoor units together with the existing infrastructure drastically reduces the number of cables needed to collect these field signals and the amount of labour required to route the cables to the centralised units. Typically, each indoor unit supports the following signals and functions:

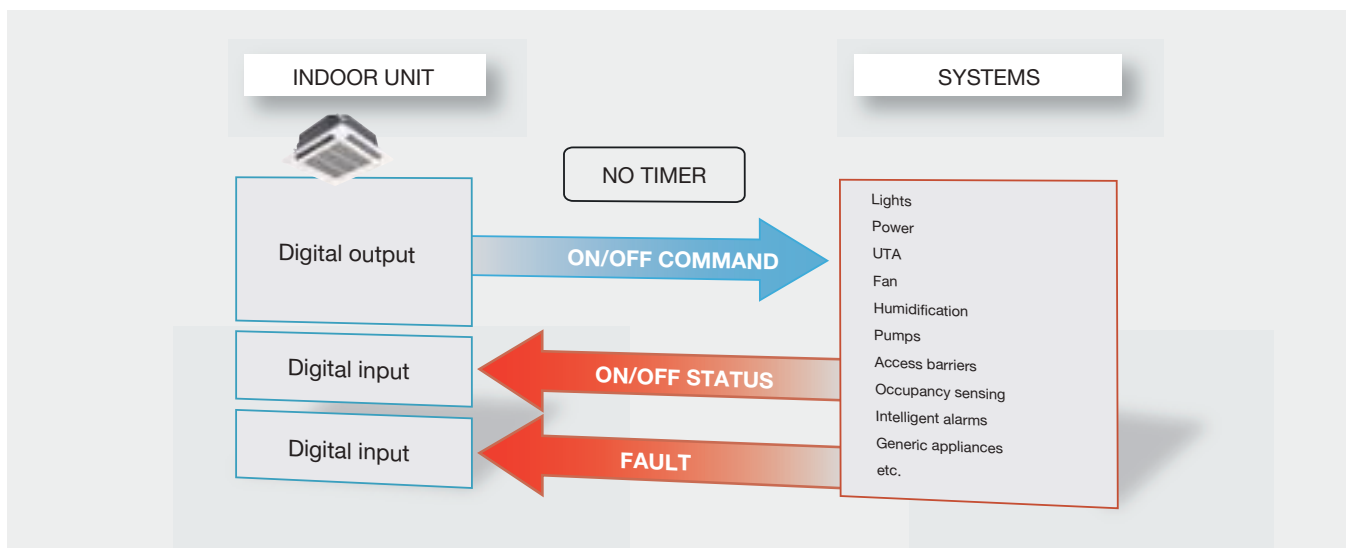

# Unique, exclusive characteristics

## Indoor units

### The LEV Kit system

The LEV Kit makes it possible to use **the residential indoor units of the Family series** – which represent the state of the art in Mitsubishi Electric air conditioning system design – together with VRF CITY MULTI systems. **Mixed** installations can therefore be created with complete freedom, using the MSZ-EF and MSZ-SF wall-mounted units and MFZ-KJ floor-standing units.



LEV KIT

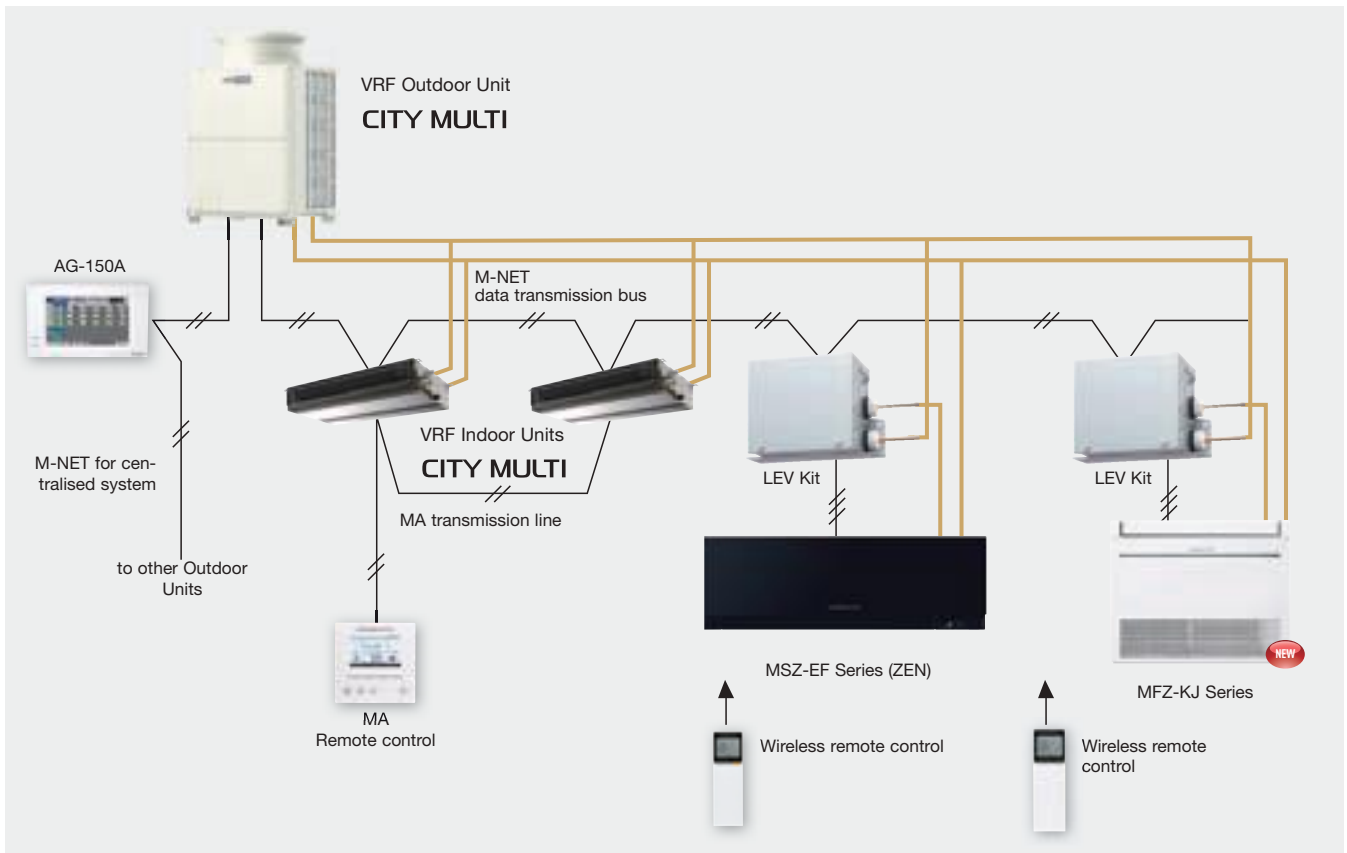

The following Mitsubishi Electric outdoor units are compatible with the LEV Kit:

- Small Y
- Y Series Ecostandard
- Y Series Nominal
- Y Series Seasonal
- Y Series Zubadan
- R2 Series Nominal
- R2 Series Seasonal
- WY/WR2 Series
- Y Series/R2 Replace Multi

Family series indoor units	15	20	22	25	35	42	50
MSZ-EF	-	-	✓	✓	✓	✓	✓
MSZ-SF	✓	✓	-	✓	✓	✓	✓
MFZ-KJ	-	-	-	✓	✓	-	✓



# Unique, exclusive characteristics

## Control Systems

### 3D TOUCH Controller



#### WEB Server centralised control unit

The 3D TOUCH Controller (AE-200E) is more than just a centralised system controller, as with its augmented processing power and memory, it now offers the same capabilities and functions as a supervisor system. Just like a BMS (Building Management System), the 3D TOUCH Controller is not necessarily constrained to the infrastructure where the system is installed. Supervision has never been so easy.

The 3D TOUCH Controller does not need a dedicated PC station, and the native web pages of the controller can be browsed from any PC to control up to 200 indoor units – offering the capability to supervise even very large, complex installations. 3D TOUCH Controller is the first and only centralised air conditioning system controller in its class with a large format 10.4” touch screen, meaning that it can also display custom graphic layouts of the installation as standard.

### PAR-U02MEDA - ADVANCED Remote Control



#### ADVANCED Remote Control for Standard Indoor Units

The new range-topping PAR-U02MEDA remote control by Mitsubishi Electric boasts an impeccable design with square, modern lines and a glass-effect polished front panel. With sophisticated looks and impressive versatility, this remote control is intuitive to use, pleasant to look at and a pleasure to show off. The new PAR-U02MEDA remote control has a large monochromatic LCD touch screen display with white backlighting that is clearly legible in all conditions and from any angle. Complete with a weekly timer function (7 days x 8 cycles per day) and simplified timer functions (ON/OFF, Auto OFF and Auto Return), the new remote control may be used together with all standard indoor units of VRF CITY MULTI systems.

The new ADVANCED PAR-U02MEDA remote control measures ambient temperature and humidity and, with its integrated occupancy and light sensors, optimises performance for maximum comfort while reducing energy consumption. The ambient temperature is displayed and set in 0.5 °C increments, while the Dual Setpoint function lets the user set different setpoint temperatures for Heat and Cool modes. A LED indicator at the bottom of the PAR-U02MEDA indicates the operating status of the indoor units with colour coded light (e.g. ORANGE for Heat mode, BLUE for Cool mode, GREEN for Dehumidification/Fan mode). PAR-U02MEDA uses ME M-Net addressing technology and can control a group of up to 16 indoor units.

### AHC - Advanced HVAC controller PLC



#### M-NET AHC PLC

Mitsubishi Electric has drawn from its experience in industrial automation to develop this sophisticated programmable controller system, which enables the Mitsubishi Electric air conditioning system to be integrated with third party installations. This allows the installation to interact with security, lighting and access control systems, etc., creating bespoke control and operating strategies for maximum energy savings and comfort.

# CITY MULTI

## Outdoor units

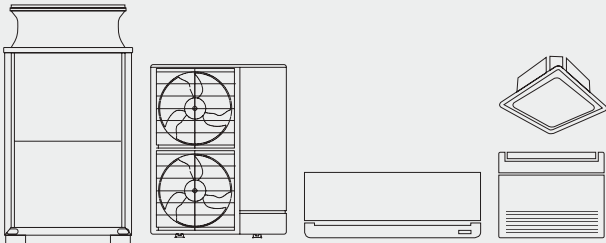

---

## INDEX

CITY MULTI The typologies .....	30
CITY MULTI Outdoor units lineup .....	34
Small Y Heat pump outdoor units .....	38
Y Ecostandard Heat pump outdoor units.....	47
Y Heat pump and R2 Heat recovery outdoor units.....	48
Y Zubadan outdoor units .....	87
WY and R2 Water source outdoor units.....	90
Y and R2 Replace Multi outdoor units.....	97
BC controllers for R2-WR2 series .....	100
WCB connection box for R2-WR2 series.....	104
CITY MULTI Model code .....	106
Refrigerant piping lenght .....	107

# CITY MULTI

## The typologies

### Y Series: The two-pipe zoned system designed for Heat Pump Operation

The CITY MULTI Small series (for small applications) and Y series (for large applications) make use of a two-pipe refrigerant system, which allows for system changeover from cooling to heating, ensuring that a constant indoor climate is maintained in all zones.

The compact outdoor unit utilizes R410A refrigerant and an INVERTER-driven compressor to use energy effectively.

With a wide line-up of indoor units in connection with a flexible piping system, the CITY MULTI series can be configured for all applications. Up to 11 (Small series) or 50 (Y series) indoor units can be connected with up to 130% connected capacity to maximize engineer's design options. This feature allows easy air conditioning in each area with convenient individual controllers.

SMALL SYSTEM (SMALL Y SERIE)



LARGE SYSTEM (Y SERIE)

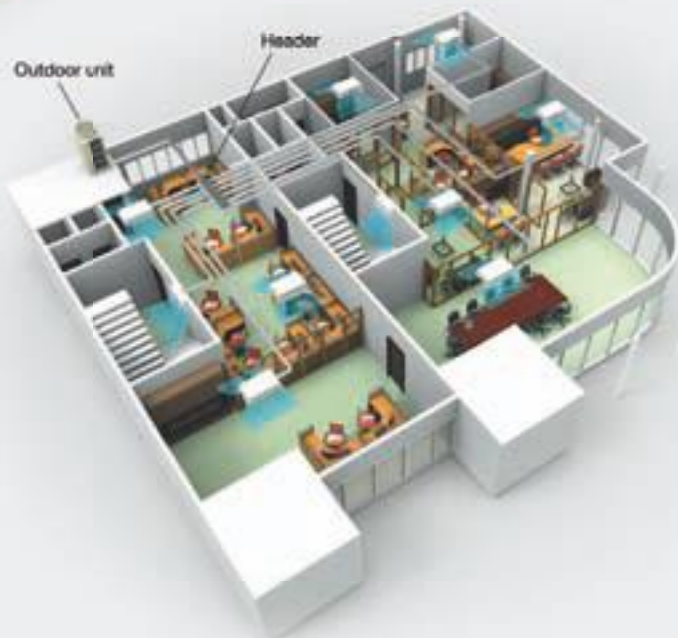



**Y ZUBADAN Series: Bringing a year round comfort solutions to extreme climates**

CITY MULTI ZUBADAN series combines the ultimate in application flexibility and powerful cooling and heating capabilities to deliver precise comfort even in the coldest days of the year down to -25°C. The technology behind this is a Flash Injection circuit which provides optimum amount of refrigerant to the system via a compressor through a specially designed injection port to ensure a particularly stable operation. With this, ZUBADAN can provide a full heating performance even at -15°C and continuous heating for up to 250 minutes in one continuous cycle, ensuring a phenomenal heating performance at low temperatures.



**R2 Series: The world's first two-pipe system that Simultaneously Cools and Heats**

CITY MULTI R2 series offers the ultimate in freedom and flexibility. Cool one zone while heating another. Our exclusive BC controller makes two-pipe simultaneous cooling and heating possible. The BC controller is the technological heart of the CITY MULTI R2 series. It houses a liquid and gas separator, allowing the outdoor unit to deliver a mixture of hot gas for heating and liquid for cooling, all through the same pipe. This innovation results in virtually no energy wasted by being expelled outdoors. Depending on capacity, up to 50 indoor units can be connected with up to 150% connected capacity.

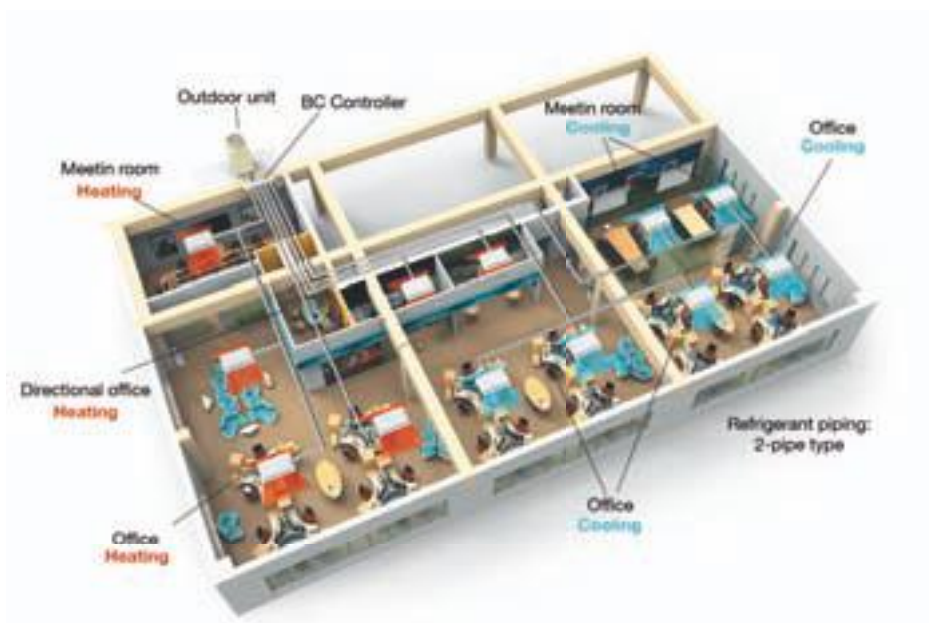

# CITY MULTI

## The typologies

### WY Series: Water energy source system allows switching between cooling and heating

The WY-Series has all the benefits of the Y-Series using water source condensing units. Condensing units can be situated indoors allowing greater design flexibility and no limitation on building size. Depending on capacity, up to 17 to 50 indoor units can be connected to a single condensing unit with individualized and/or centralized control. The two-pipe system allows all CITY MULTI solutions to switch between cooling and heating while maintaining a constant indoor temperature.

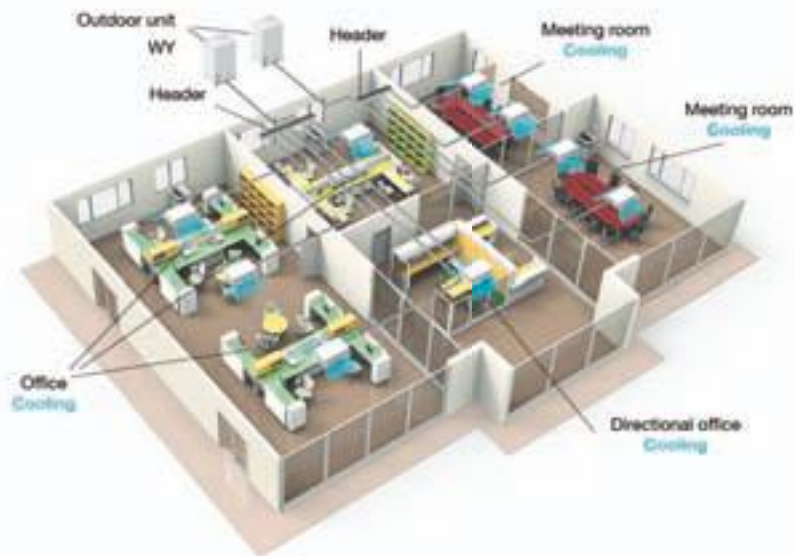

### WR2 Series: Advanced water heat source unit enjoying the benefits of R2 series

The CITY MULTI WR2 series provides all of the advantages of the R2 series with the added advantages of a water heat source system, making it suitable for wider range of applications in high rises, frigid climates, coastal areas, etc. Not only does it produce heat recovery from the indoor units on the same 2-pipe refrigerant circuit, it also produces heat recovery via the water circuit between heat source units, making it a very economical system.

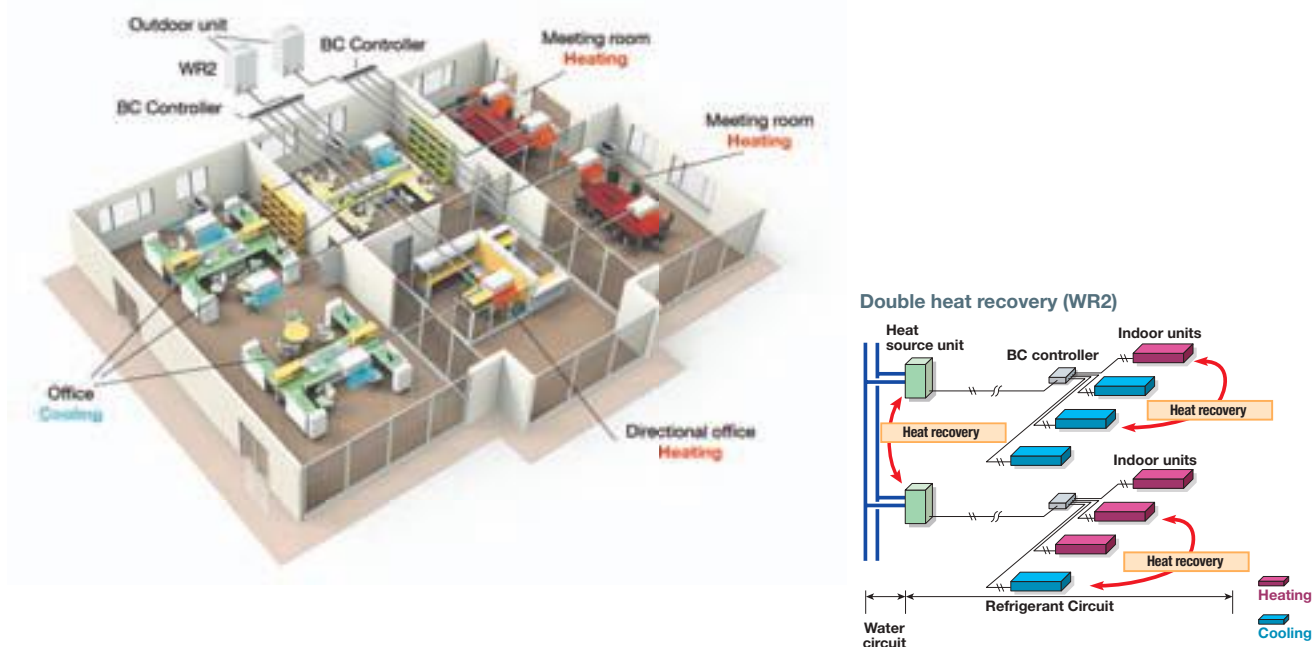



**Replace Multi Series: 3-R of the new system dedicated to the replacement of VRF R22 systems**

The Mitsubishi Electric solution for the replacement market of VRF R22 systems is characterized by the 3-R: Re-use, Re-placement and Re-newal. The innovative **Replace Multi** solution of Mitsubishi Electric makes it possible to reuse components and structural elements of existing plant rather than completely replace all units and refrigerant lines. This raises the owner from discomforts of the complete replacement of the air conditioning system (for example, new pipes, the destruction walls and stopping of the activities and business during the renovations).

**Short and quick construction process and time**

Compared to the installation process and time to install a complete new system, REPLACE MULTI offers shorter and quicker installation. The key cause of this is because with REPLACE MULTI, without any use of special kit, existing piping can be reused and works at rooftop or walls for new piping are not required. This results in reduced installation time and system downtime which is an attractive factor to minimize the effect on business working hours.

✓...Reusable ✕...Not reusable

	Refrigerant pipes	Power circuits	Switches	Trasmission lines	Remote controls trasmission circuit	Outdoor unit	Indoor unit
Reuse	✓	✓	✓	✓	✓	✕	✕*

NOTE: The actual reusability of components depends upon the condition of the plant and the existing infrastructure.

\* The actual reusability of indoor units depends on the model. For further clarification please contact the sales office nearest you.

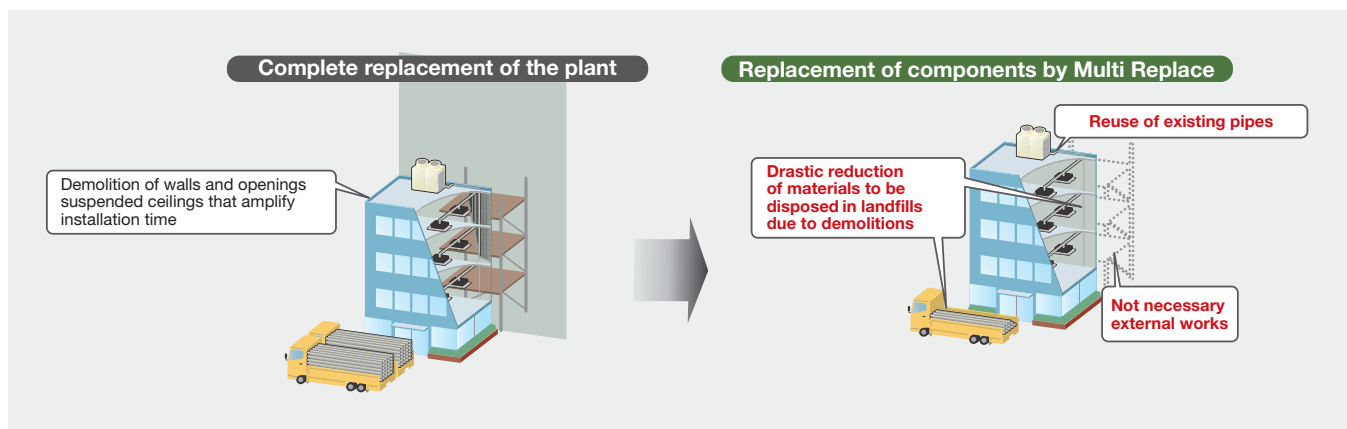

**Short and quick construction process and time**

Compared to the installation process and time to install a complete new system, REPLACE MULTI offers shorter and quicker installation.

The key cause of this is because with REPLACE MULTI, without any use of special kit, existing piping can be reused and works at rooftop or walls for new piping are not required. This results in reduced installation time and system downtime which is an attractive factor to minimize the effect on business working hours.

**Renewal for top performance**

The installation of a Replace Multi system allows to achieve the state of the art of VRF technology from Mitsubishi Electric which it reached levels of energy efficiency (COP) more than 40% compared to a R22 VRF system of 10 years ago. The greater energy efficiency also means lower noise levels and reduced installation space compared to a VRF R22.

# CITY MULTI Outdoor units lineup



## CITY MULTI SMALL Y SYSTEM

Compact heat pump systems.

PUMY-P YKM1 THREE-PHASE - HP 4,5-8  
PUMY-P VKM1 MONO-PHASE - HP 4,5-6



## CITY MULTI Y SYSTEM

Heat pump systems.

**SINGLE Y**  
PUHY-P YKA - HP 8~20  
**DOUBLE Y**  
PUHY-P YSKA - HP 22~40  
**LARGE Y**  
PUHY-P YSKA - HP 42~60



## CITY MULTI Y SYSTEM

Heat pump systems with continuous heating optimized for maximum performance at nominal load conditions.

**SINGLE Y**  
PUHY-P YKB-A1 (-BS) - HP 8~14  
**DOUBLE Y**  
PUHY-P YSKB-A1 (-BS) - HP 16~36  
**LARGE Y**  
PUHY-P YSKB-A1 (-BS) - HP 38~54



## CITY MULTI Y SYSTEM

Heat pump systems with continuous heating optimized for high performance seasonal.

**SINGLE Y**  
PUHY-EP YLM-A1 (-BS) - HP 8~20  
**DOUBLE Y**  
PUHY-EP YSLM-A1 (-BS) - HP 22~24  
**LARGE Y**  
PUHY-EP YSLM-A1 (-BS) - HP 26~54



## CITY MULTI Y ZUBADAN SYSTEM

Heat pump systems optimized for cold climates.

PUHY-HP YHM-A (-BS) - HP 8~10  
PUHY-HP YSHM-A (-BS) - HP 16~20



**ZUBADAN**



### REPLACE MULTI Y SYSTEM

Heat pump systems for the replacement of VRF R22 / R407C Heat pumps.

PUHY-RP YJM-B (-BS) - HP 8~14



### CITY MULTI R2 SYSTEM

Two-pipes Cooling / Heating simultaneous systems with heat recovery and continuous heating optimized for maximum performance at rated load conditions.

**SINGLE R2**  
PURY-P YLM-A1 (-BS) - HP 8~14

**DOUBLE R2**  
PURY-P YSLM-A1 (-BS) - HP 16~36



### CITY MULTI R2 SYSTEM

Two-pipes Cooling / Heating simultaneous systems with heat recovery and continuous heating optimized for seasonal high performance.

**SINGLE R2**  
PURY-EP YLM-A1 (-BS) - HP 8~20

**DOUBLE R2**  
PURY-EP YSLM-A1 (-BS) - HP 22~36



### REPLACE MULTI R2 SYSTEM

Heat recovery systems for the replacement of VRF R22 / R407C heat recovery systems.

PURY-RP YJM-B (-BS) - HP 8~12



### CITY MULTI WR2/WY SYSTEM

Heat recovery systems condensated / evaporated by water.

**SINGLE WR2/WY**  
PQRY/PQHY-P YHM-A - HP 8~12

**DOUBLE WR2/WY**  
PQRY/PQHY-P YSHM-A - HP 16~24

**TRIPLE WY**  
PQHY-P YSHM-A - HP 26~36



System	Serie	Model name	Image	HP	4,5	5	6	8	10	12	14	16	18	20	
					Model	P112	P125	P140	P200	P250	P300	P350	P400	P450	P500
Air Condensed	Compact heat pump <b>SMALL Y</b>	SMALL Y Series PUMY-P YKM2(-BS) PUMY-P VKM2(-BS)		1-PHASE	4,5	5	6								
				3-PHASE	4,5	5	6	8							
	Heat-pump <b>Y ECOSTANDARD</b>	Y Ecostandard Series PUHY-P YKA(-BS) PUHY-P YSKA(-BS)		SINGLE				8	10	12	14	16	18	20	
				DOUBLE											
				TRIPLE											
	Nominal conditions heat-pump <b>Y NOMINAL</b>	Y Series PUHY-P YKB-A1(-BS) PUHY-P YSKB-A1(-BS)		SINGLE				8	10	12	14	16	18	20	
				DOUBLE								8+8	8+10	10+10	
				TRIPLE											
	Seasonal conditions heat-pump <b>Y SEASONAL</b>	Y Series PUHY-EP YLM-A1(-BS) PUHY-EP YSLM-A1(-BS)		SINGLE				8	10	12	14	16	18	20	
				DOUBLE											
				TRIPLE											
	Zubadan heat-pump <b>Y ZUBADAN</b>	Y Series PUHY-HP YHM-A(-BS) PUHY-HP YSHM-A(-BS)		SINGLE				8	10						
DOUBLE											8+8		10+10		
Heat recovery Nominal conditions <b>R2 NOMINAL</b>	R2 Series PURY-P YLM-A1(-BS) PURY-P YSLM-A1(-BS)		SINGLE				8	10	12	14					
			DOUBLE								8+8	8+10	10+10		
Heat recovery Seasonal conditions <b>R2 SEASONAL</b>	R2 Series PURY-EP YLM-A1(-BS) PURY-EP YSLM-A1(-BS)		SINGLE				8	10	12	14	16	18	20		
			DOUBLE												
Water condensed	Heat-pump <b>WY</b>	WY Series PQHY-P YHM-A PQHY-P YSHM-A		SINGLE				8	10	12					
				DOUBLE								8+8	8+10	10+10	
				TRIPLE											
Heat recovery <b>WR2</b>	WR2 Series PQRY-P YHM-A PQRY-P YSHM-A		SINGLE				8	10	12						
			DOUBLE								8+8	8+10	10+10		
Air condensed For R22/407 systems replacement	Heat-pump Replace Multi <b>Y REPLACE MULTI</b>	Y Series PUHY-RP YJM-B(-BS) PUHY-RP YSJM-B(-BS)		SINGLE				8	10	12	14				
				DOUBLE								8+8	8+10	10+10	
				TRIPLE											
Heat recovery Replace Multi <b>R2 REPLACE MULTI</b>	R2 Series PURY-RP YJM-B(-BS) PURY-RP YSJM-B(-BS)		SINGLE					8	10	12					

22	24	26	28	30	32	34	36	38	40	42	44	46	48	50	52	54	56	58	60
P550	P600	P650	P700	P750	P800	P850	P900	P950	P1000	P1050	P1100	P1150	P1200	P1250	P1300	P1350	P1400	P1450	P1500
10+12	10+14	10+16	10+18	12+18	16+16	16+18	18+18	18+20	20+20										
										12+12 +18	12+14 +18	14+16 +16	16+16 +16	16+16 +18	16+18 +18	18+18 +18	18+18 +20	18+20 +20	20+20 +20
10+12	10+14	12+14	14+14	14+16	14+18	16+18	18+18												
								10+12 +16	12+12 +16	12+14 +16	14+14 +16	14+14 +18	14+16 +18	14+18 +18	16+18 +18	18+18 +18			
10+12	12+12																		
		8+8 +10	8+8 +12	8+10 +12	8+12 +12	10+12 +12	12+12 +12	12+12 +14	12+12 +16	12+14 +16	14+14 +16	14+14 +18	14+16 +18	14+18 +18	16+18 +18	18+18 +18			
10+12	12+12	12+14	14+14	14+16	16+16	16+18	18+18												
10+12	12+12	12+14	14+14	14+16	16+16	16+18	18+18												
10+12	12+12																		
		10+8 +8	10+10 +8	10+10 +10	12+10 +10	12+12 +10	12+12 +12												
10+12	12+12																		
10+12	12+12	12+14																	
			8+10 +10	10+10 +10	10+10 +12	10+12 +12	12+12 +12												

# Outdoor units

## Small Y serie

More quietness thanks to the new fan

---

Connectable to **ecodan** ATW modules for hot water production<sup>\*1</sup>  
Renewable Heating Technology

---

Geometric piping limitations increased

---

H.I.C. Circuit (heat inter charger)  
for the subcooling control

---

Heating operation range extended up  
to -20°C outdoor temperature

---

<sup>\*1</sup> Available on 4.5-5-6 Hp







Power range extended with the introduction of the new 8 HP three-phase size

NEW

New chassis with increased heat exchange surface

Increased reliability

Top performance and COP > 4 on the entire range

Connectable to residential indoor units series by LEV Kit

Native Replace Technology function for the replacement of R22 systems

# Characteristics of SMALL Y outdoor units serie

## New PUMY Y(V)KM – The smallest, but with all the technology and efficiency of our bigger units



The Small Y (PUMY) series of outdoor units by Mitsubishi Electric, which now offers 7 different variants (with single and three-phase 4.5, 5 and 6 HP versions and a three-phase 8 HP version), is the ideal solution for large homes and medium-sized offices. These outdoor units may be connected to up to 12 indoor units of different type and power rating. This system offers exceptional savings in operating costs and is suitable for both residential and commercial applications.

## Class-beating energy efficiency

The new Small Y (PUMY) series has been designed to offer extraordinary levels of energy efficiency in both summer (EER) and winter (COP) operation. The entire range scores **COP values above 4**, making these units usable even in regions where legislation sets more restrictive performance limitations.

## Total comfort. Even at -20°C

The new Small Y (PUMY) series is now capable of operating in heating mode over an even broader temperature range (from -20 to +15 °C).

## New chassis with larger heat exchange surface area

The new design of the Small Y (PUMY) series has made it possible to use a direct expansion coil with greater heat exchange surface area and density. Together with the introduction of the **Heat Inter Charger** overcooling circuit – a technological solution now appearing for the first time in units of this series – these improvements ensure superlative performance and extraordinary energy efficiency in cooling mode. The flat fin configuration of the coil and special Blue Fin treatment protect the coil itself against corrosion, ensuring that the unit continues to function with the same outstanding thermal exchange efficiency and performance over time.

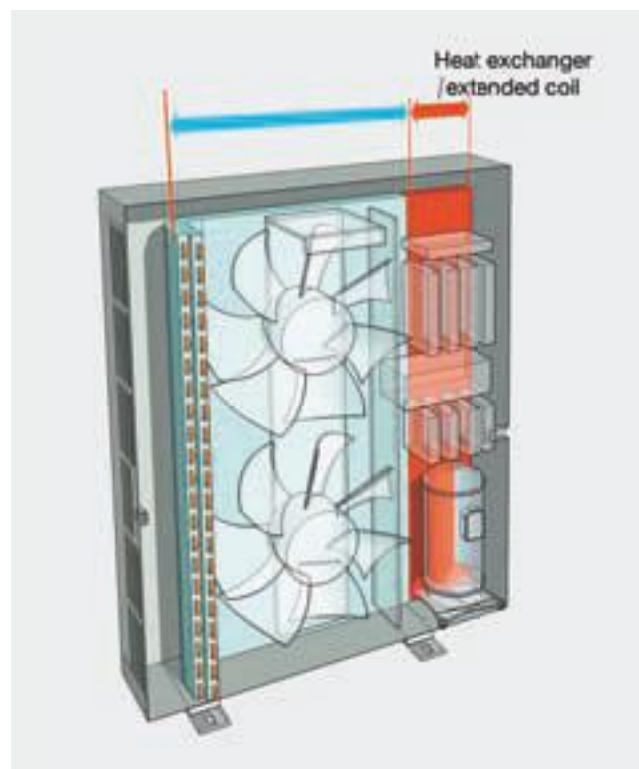



**The power of a VRF, the elegance of a residential Multi-Split**

With the **LEV KIT** and the new dedicated **Branch Box**<sup>1</sup> (available as 3 and 5 connection versions), the outdoor units of the Small Y series can now be connected to the entire range of **residential and commercial**<sup>2</sup> indoor units, with looks that are perfectly suited to applications (such as residential buildings and hotels) where design and elegance are decisive factors in the choice of indoor units.

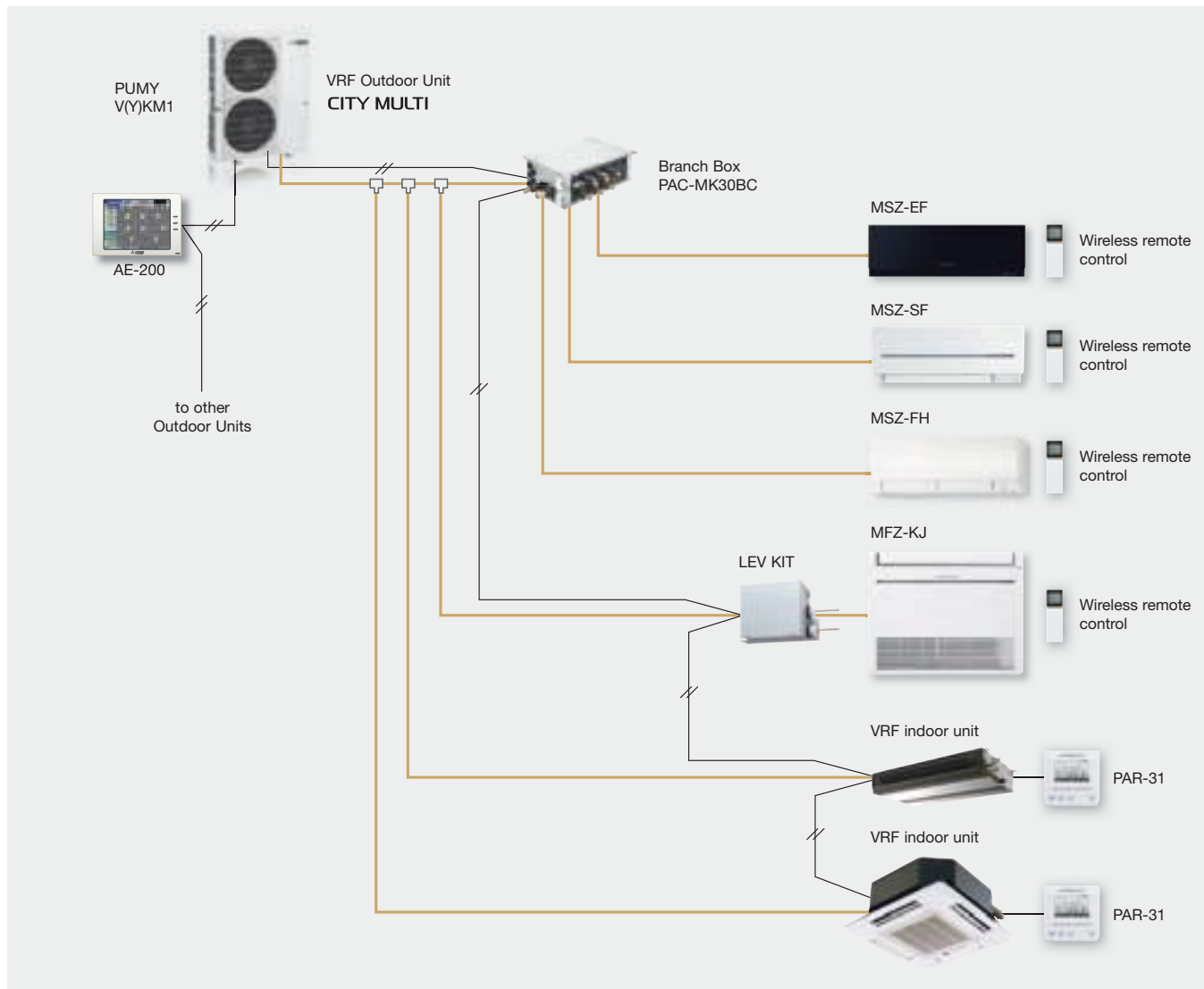

<sup>1</sup> The PUMY P200 is not compatible with the Branch Box.

<sup>2</sup> Except for MSZ-HJ.

**New Branch Boxes (3 or 5 connections) - Total flexibility**

The new Branch Boxes are designed to offer the greatest configuration flexibility possible for the system. This makes it possible to create systems consisting entirely of CITY MULTI VRF units, systems with Residential/Commercial series indoor units only, or mixed systems with both types of unit.

Model	1 Branch Box		2 Branch Boxes	
	Branch Box ways	CITY MULTI Indoor units	Branch Box ways	CITY MULTI Indoor units
PUMY-P112	Max. 5	Max. 5	Max. 7	Max. 3
			Max. 8	Max. 2
PUMY-P125	Max. 5	Max. 5	Max. 8	Max. 3
PUMY-P140				Max. 3

# Characteristics of SMALL Y outdoor units serie

## Mixed systems – Heating/cooling and hot water production

The Small Y (PUMY) range, available as 4.5, 5 and 6 HP versions, may be used together with **Ecodan® ATW** hydronic modules, making it possible to create mixed systems providing radiant panel heating and air cooling.

Small Y (PUMY) series units may be connected to **Ecodan® ATW hydronic modules** to produce **hot water** up to **50 °C**. An installation consisting of hydronic modules and indoor air conditioner units is capable of managing the two distribution systems (WATER and AIR) independently. For example, this means that the installation can cover heating demand in winter with an **underfloor heating system**, and activate the indoor air conditioner units in summer, spring and autumn to heat or cool rooms as necessary.

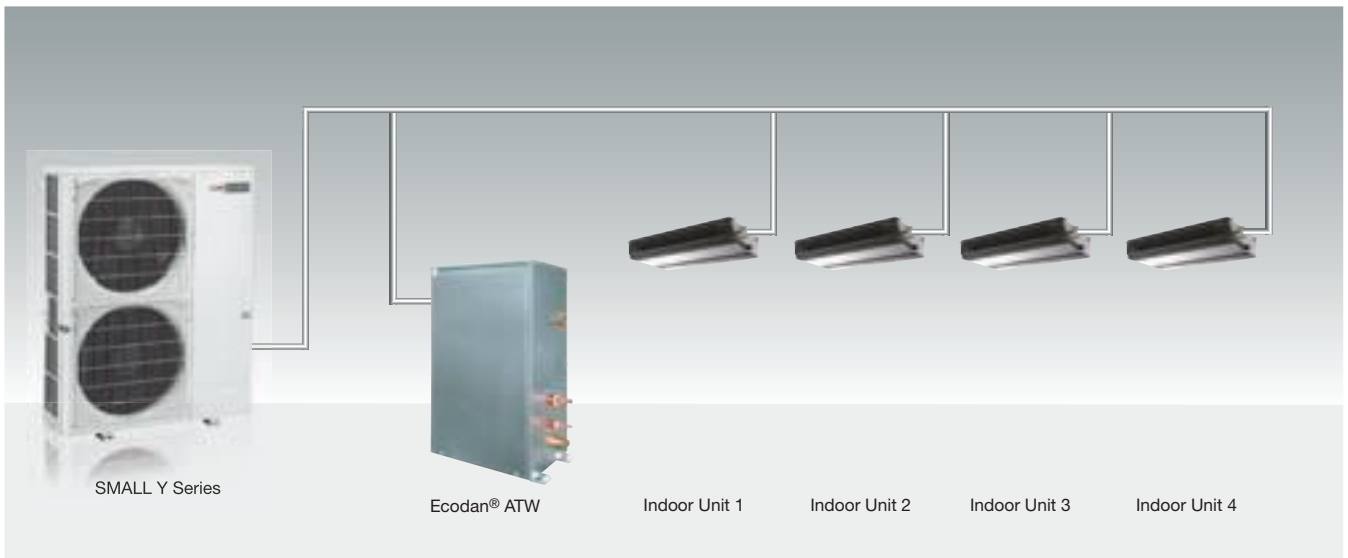

## Unparalleled silence

The new fans cut through the air more effectively and minimise turbulence, for superlative static overpressure with **minimum noise impact**. These fans generate a **10% higher outdoor air flow than the previous version** while operating at the same noise levels. Small Y (PUMY) is also capable of operating in “low noise”

mode, reducing sound pressure levels by 2 dB. By connecting an external timer or switch to the fan, this mode can be set for specific time brackets during the day.

## New fan

Diameter increased from 490 mm to 550 mm.

The new fan has longer, differently shaped blades to direct air more effectively, reduce turbulence and increase efficiency.

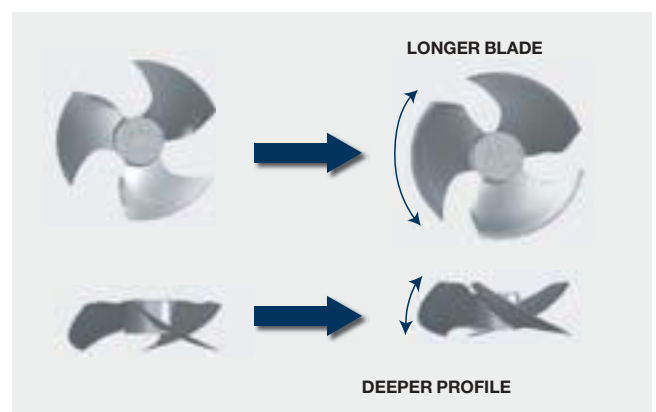



**AC PRE-HEATING compressor pre-heating system**

An **AC pre-heating system** is used for the compressor. The pre-heat routine is based on the temperature of the refrigerant and of the compressor.

AC control reduces power absorption in stand-by state, increasing seasonal efficiency.

**Total flexibility for installation and maintenance**

With increased geometric limits for piping, the Small Y (PUMY) series offers unparalleled flexibility for installation. No additional refrigerant charge is necessary, provided that the length of the refrigerant line does not exceed 50 m.

**INCREASED GEOMETRICAL LIMITS FOR PIPING** NEW

	PUMY Y(V)HM	PUMY P112-P125-P140 Y(V)KM
Total effective length	120 m	300 m
Effective length of a single circuit	80 m	150 m
Maximum vertical difference between indoor units	12 m	15 m
"Maximum vertical difference between indoor and outdoor units (with outdoor unit in lower position)"	20 m	40 m

**New PUMY Y(V)KM with Replace Technology – Absolute simplicity, even when replacing systems**

The EU regulation 2037/2000/EC **has banned the use of virgin HCFC refrigerants (R22)** since 1/1/2010. As a result, in the event of a fault or even just a refrigerant leak in an air conditioning system using R22, it is no longer possible to recharge the system. With small to medium-sized installations in particular, the most cost effective solution is to replace the entire air conditioning system. This is because of the following reasons:

- New generation outdoor units with R410A are much more efficient, with lower electric power consumption;
- They are quieter and offer more effective air filtration;
- Taking advantage of tax rebates offered for replacing winter air conditioning systems will minimise the time necessary to recoup the initial outlay.

The main problem in replacing an existing air conditioner using R22 fluid with a system using new R410A refrigerant is posed by the residue of chlorine and mineral oils remaining in the existing piping onto which the air conditioner system containing R22

was connected. This residue is extremely harmful for the new air conditioner, and unless the circuit is flushed out extremely thoroughly, may degrade the new oil and/or cause obstructions in the refrigerant circuit and, as a result, lead to system malfunctions. Moreover, the diameters and thickness of the existing piping may not be compatible with the new units.

The **Small Y (PUMY)** series of outdoor units features **Mitsubishi Electric Replace Technology**, which allows the **existing piping to be used** without modification, even with piping with different diameters and wall thicknesses. By using exclusive HAB oil and special low friction technology for the compressor, the majority of our air conditioners may operate with the original piping, cutting installation times and costs and material costs while minimising environmental impact.

# Series Small Y



## OUTDOOR UNITS PUMY-P V(Y)KM2



### TECHNICAL SPECIFICATIONS

MODEL			PUMY-P112VKM2(-BS)	PUMY-P125VKM2(-BS)	PUMY-P140VKM2(-BS)	
<b>HP</b>			4.5	5.0	6.0	
<b>Power</b>	Voltage/Freq./Phases	V/Hz/n°	Single phase 220-230-240V 50Hz			
<b>Cooling</b>	Nominal capacity <sup>1</sup>	kW	12.5	14.0	15.5	
	Power absorption	kW	2.79	3.46	4.52	
	EER		4.48	4.05	3.43	
	Operating temperature range	Indoor WB	°C	15.0~24.0	15.0~24.0	15.0~24.0
Outdoor DB		°C	-5.0~46.0	-5.0~46.0	-5.0~46.0	
<b>Heating</b>	Nominal capacity <sup>2</sup>	kW	14.0	16.0	18.0	
	Power absorption	kW	3.04	3.74	4.47	
	COP		4.61	4.28	4.03	
	Operating temperature range	Indoor DB	°C	15.0~27.0	15.0~27.0	15.0~27.0
		Outdoor WB	°C	-20.0~15.0	-20.0~15.0	-20.0~15.0
<b>Sound pressure<sup>3</sup></b>	Heating mode	dB(A)	51	52	53	
	Cooling mode	dB(A)	49	50	51	
<b>Connectable indoor units</b>	Total capacity		50 to 130% of capacity of O.U.			
	Model/Quantity		P15~P140 / 1~9	P15~P140 / 1~10	P15~P140 / 1~11	
<b>External diameter of refrigerant connectors</b>	Liquid	mm	9.52	9.52	9.52	
	Gas	mm	15.88	15.88	15.88	
	Fan air flow rate	m <sup>3</sup> /min	110	110	110	
	External dimensions (HxLxW)	mm	1338x1050x330	1338x1050x330	1338x1050x330	
	Net weight	kg	123	123	123	
	R410A refrigerant charge quantity	kg	4.8	4.8	4.8	



### TECHNICAL SPECIFICATIONS

MODEL			PUMY-P112YKM2(-BS)	PUMY-P125YKM2(-BS)	PUMY-P140YKM2(-BS)	
<b>HP</b>			4.5	5.0	6.0	
<b>Power</b>	Voltage/Freq./Phases	V/Hz/n°	3-phase, 380-400-415V, 50Hz			
<b>Cooling</b>	Nominal capacity <sup>1</sup>	kW	12.5	14.0	15.5	
	Power absorption	kW	2.79	3.46	4.52	
	EER		4.48	4.05	3.43	
	Operating temperature range	Indoor WB	°C	15.0~24.0	15.0~24.0	15.0~24.0
Outdoor DB		°C	-5.0~46.0	-5.0~46.0	-5.0~46.0	
<b>Heating</b>	Nominal capacity <sup>2</sup>	kW	14.0	16.0	18.0	
	Power absorption	kW	3.04	3.74	4.47	
	COP		4.61	4.28	4.03	
	Operating temperature range	Indoor DB	°C	15.0~27.0	15.0~27.0	15.0~27.0
		Outdoor WB	°C	-20.0~15.0	-20.0~15.0	-20.0~15.0
<b>Sound pressure<sup>3</sup></b>	Heating mode	dB(A)	51	52	53	
	Cooling mode	dB(A)	49	50	51	
<b>Connectable indoor units</b>	Total capacity		50 to 130% of capacity of O.U.			
	Model/Quantity		P15~P140 / 1~9	P15~P140 / 1~10	P15~P140 / 1~11	
<b>External diameter of refrigerant connectors</b>	Liquid	mm	9.52	9.52	9.52	
	Gas	mm	15.88	15.88	15.88	
	Fan air flow rate	m <sup>3</sup> /min	110	110	110	
	External dimensions (HxLxW)	mm	1338x1050x330	1338x1050x330	1338x1050x330	
	Net weight	kg	125	125	125	
	R410A refrigerant charge quantity	kg	4.8	4.8	4.8	

<sup>1</sup> Nominal cooling conditions: Indoor: 27°C DB / 19°C WB. Outdoor 35°C DB. Piping length 7.5 m, vertical difference 0 m.

<sup>2</sup> Nominal heating conditions: Indoor 20°C DB. Outdoor 7°C DB / 6°C WB. Piping length 7.5 m, vertical difference 0 m.

<sup>3</sup> Values measured in anechoic chamber.

# Characteristics of SMALL Y Series, 8HP



## The power and performance of a VRF with the compact dimensions of a multisplit

The new PUMY-P200YKM 8HP is the ideal solution for all applications where there can be no compromise in efficiency, power and installation flexibility – even where installation space is limited.

## Superior power with compact dimensions

The new PUMY 8HP offers heating and cooling capacities which, until now, were the sole preserve of larger, more powerful systems. The outdoor units of the PUMY range have a very compact chassis, making them ideal for installation in situations with limited space, such as balconies and small patios.

### 8HP COMPARED



## TECHNICAL SPECIFICATIONS

MODEL				PUMY-P200YKM(-BS)
<b>HP</b>				8.0
<b>Power</b>	Voltage/Freq./Phases	V/Hz/n°	3-phase, 380-400-415V, 50Hz	
<b>Cooling</b>	Nominal capacity <sup>1</sup>	kW	22.4	
	Power absorption	kW	6.05	
	EER		3.70	
	Operating temperature range	Indoor WB	°C	15~24.0
Outdoor DB		°C	-5~46.0	
<b>Heating</b>	Nominal capacity <sup>2</sup>	kW	25.0	
	Power absorption	kW	5.84	
	COP		4.28	
	Operating temperature range	Indoor DB	°C	15.0~27.0
Outdoor WB		°C	-20.0~15.0	
<b>Sound pressure<sup>3</sup></b>	Heating mode	dB(A)	61	
	Cooling mode	dB(A)	56	
<b>Connectable indoor units</b>	Total capacity		50 to 130% of capacity of O.U.	
	Model/Quantity		P15~P250 / 1~12	
<b>External diameter of refrigerant connectors</b>	Liquid	mm	9.52	
	Gas	mm	19.05	
	Fan air flow rate	m <sup>3</sup> /min	141	
	External dimensions (HxLxW)	mm	1338x1050x330	
	Net weight	kg	138	
	R410A refrigerant charge quantity	kg	7.3	

<sup>1</sup> Nominal cooling conditions: Indoor: 27°C DB / 19°C WB - Outdoor 35°C DB. Piping length 7.5 m, vertical difference 0 m.

<sup>2</sup> Nominal heating conditions: Indoor 20°C DB. Outdoor 7°C DB / 6°C WB. Piping length 7.5 m, vertical difference 0 m.

<sup>3</sup> Values measured in anechoic chamber.

# Y Ecostandard heat pump outdoor units

NEW

Outdoor unit optimised  
for cooling performance (EER)

Single module system for installations up to 20HP,  
for minimised space usage and extreme simplicity  
of installation

Extended operating range in cooling mode,  
with maximum temperatures up to 52°C

Max size up to 60 HP

Evaporating temperature control system (E.T.C.)







New flanged duct and new DC inverter fan motor

More compact and lighter than YHA outdoor unit series

Conventional bi-metal (copper/aluminium) heat exchanger

Extended piping length

# Y heat pump outdoor units

## R2 heat recovery outdoor units



Outdoor unit optimised for nominal performance (COP, EER)

New flanged duct and new DC inverter fan motor

Single module system for installations up to 20HP, for minimised space usage and extreme simplicity of installation

More compact and lighter than YJM outdoor unit series

Evaporation temperature control system (ETC)

Continuous heating, with new heat exchange coil with adjustable flow system

Extended piping length

Conventional bi-metal (copper/aluminium) heat exchanger

Extended operating range in cooling mode, with maximum temperatures up to 52°C\*1

New Scroll compressor with DC Inverter motor and induction pre-heating system\*2

\*1 For Y Series Nominal only.  
\*2 For R2 Series Nominal only.

# Y heat pump outdoor units

## R2 heat recovery outdoor units



Outdoor unit optimised for seasonal performance (SCOP, SEER)

New flanged duct and new DC inverter fan motor

Single module system for installations up to 20HP, for minimised space usage and extreme simplicity of installation

More compact and lighter than YJM outdoor unit series

Evaporation temperature control system (ETC)

Continuous heating, with new heat exchange coil using split operation technology

New Bottom SubCool Circuit (BSCC) refrigeration circuit

All aluminium FLAT TUBE heat exchanger with high thermal exchange efficiency micro-channels



Extended operating range in cooling mode, with maximum temperatures up to 52°C\*

New Scroll compressor with DC Inverter motor and induction pre-heating system



\* For Y Series Seasonal only.

# Y heat pump outdoor units

## R2 heat recovery outdoor units



### Evaporation Temperature Control (ETC)

The new Evaporation Temperature Control (ETC) function for cooling mode reduces the energy consumption of the system by up to 20% by controlling the refrigerant temperature in relation to load and increasing the evaporation temperature. Increasing efficiency means, above all, eliminating waste. A conventional air conditioner system functions effectively as long as it can deliver thermal energy (heating or cooling) in relation to external conditions (which depend on thermal loads) to maintain optimum comfort conditions in the environment. In addition to maintaining optimum comfort conditions in the environment, a Mitsubishi Electric air conditioning system also ensures that the least energy possible is used to do so, by adapting in real time to the effective operating conditions. The new Y Series (Ecostandard, Nominal and Seasonal) and R2 Series (Nominal and Seasonal) outdoor units continuously monitor ambient parameters and adapt to the effective thermal load, so that the entire system functions in the ideal conditions in terms of efficiency and, as a result, economy. The evaporation temperature is raised in relation to operating load, reducing the power absorbed by the compressor and increasing the efficiency of the system, cutting energy consumption.

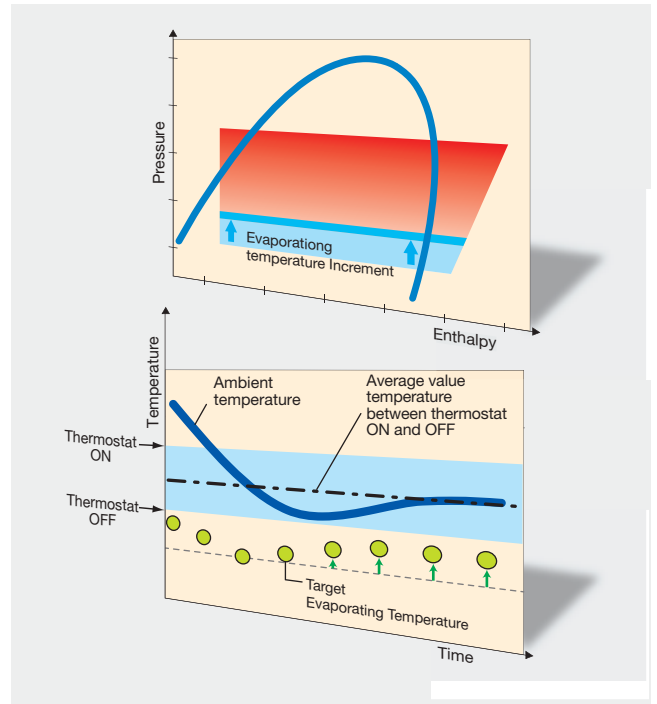

The ETC function increases the SHF (Sensible Heat Factor), allowing for higher delivery air temperatures and, as a result, greater comfort.

Option	Target evaporation temperature	Delivery air temperature	Sensible Heat Factor	Total capacity	System efficiency
Standard	0	9°C	0.78	100%	100%
Hi 1	6	12°C	0.87	75%	105%
Hi 2	9	14°C	0.92	60%	110%
Hi 3	14	16°C	0.96	50%	115%

**Notes:**  
 Operating parameters calculated for a PEFY-P63VMA indoor unit e PURY-EP200YLM-A outdoor unit. Indoor temperature conditions: 21 °C DB, 15 °C WB, at high fan speed setting.  
 Outdoor temperature conditions: 27 °C DB, 19 °C WB.



**Fan: new geometry and DC Inverter motor**

The new **Y Series (Ecostandard, Nominal and Seasonal)** and **R2 Series (Nominal and Seasonal)** outdoor units are equipped with an innovative flanged air duct. This new geometry takes advantage of the Venturi effect, allowing the fan rotor to rotate at lower speeds, reducing electrical power absorption, while increasing the residual overpressure at the outlet of the duct itself.

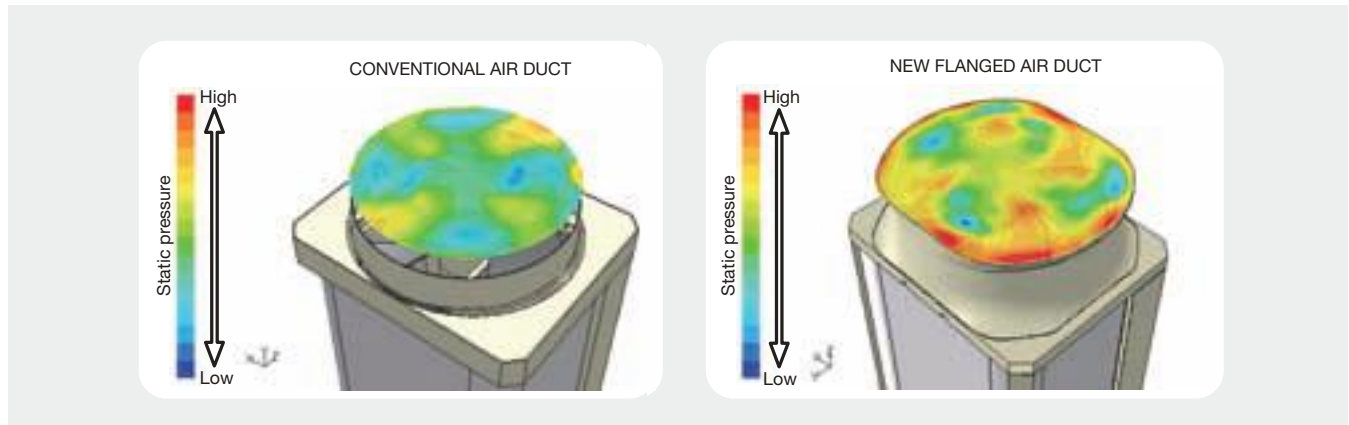

**Fan: effective static pressure for outdoor units of up to 60Pa**

On both Y Series and R2 Series units, a static pressure of **30Pa** or **60Pa** may be selected, to cater for the air ducting needs of the outdoor unit more flexibly.

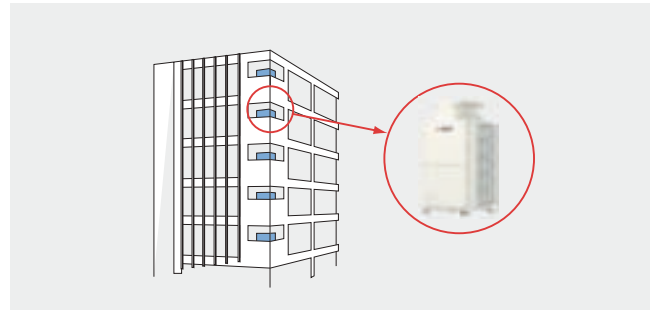

**Extended operating temperature range**

**Y Series (Ecostandard, Nominal and Seasonal)** and **R2 Series (Nominal and Seasonal)** outdoor units offer an extended operating temperature range, from a minimum temperature of **-20 °C DB** (in heating mode) to a maximum of **+52 °C WB** (in cooling mode). In comparison, the previous YJM series offered a range from **-20°C DB** to **+46°C WB**.

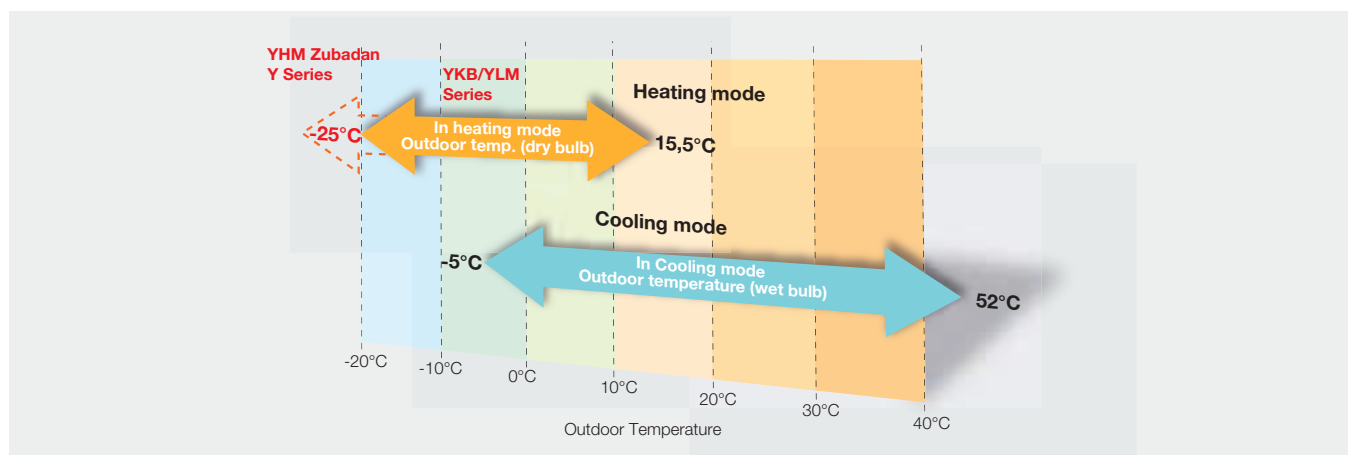

# Y heat pump outdoor units

## R2 heat recovery outdoor units



### Increased geometric limits

The new **Y Series (Ecostandard, Nominal and Seasonal)** and **R2 (Nominal and Seasonal)** outdoor units are subject to less restrictive geometric limitations for connections. By using larger diameter piping, the maximum distance between the first joint to the farthest indoor unit can now be extended. This measure may also be used to increase the maximum vertical difference between indoor units.

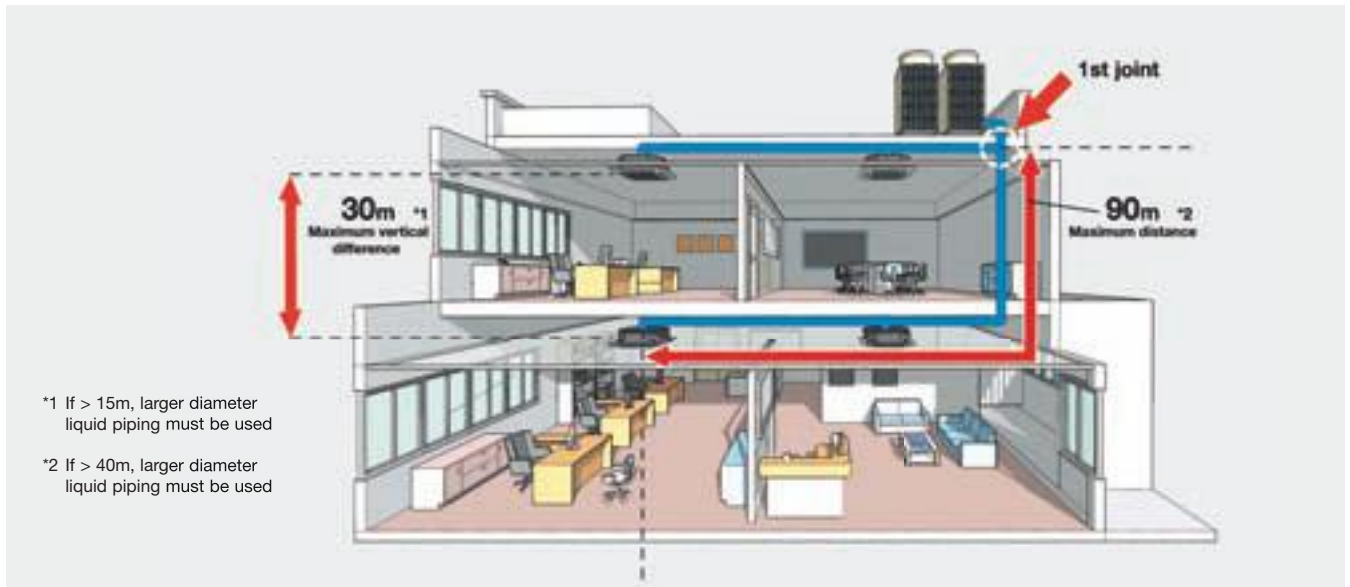

### Operating mode

For unparalleled flexibility, **Y Series (Ecostandard, Nominal and Seasonal)** and **R2 Series (Nominal and Seasonal)** outdoor units offer two different operating modes to cater for all possible needs:

- Capacity Mode
- Efficiency Mode (COP)

In Capacity Mode, the outdoor units deliver a HEATING capacity on average 15% higher than in Efficiency Mode (COP).

The P200 variant (8HP), for example, is capable of delivering

100% capacity in heating mode to outdoor air temperatures as low as -2.5°C. Conversely, in Efficiency Mode (COP), the outer units maintain the ideal balance between capacity and power absorption throughout the entire outdoor air temperature operating range. The two modes are selectable from a dip switch on the outdoor unit.

The units are set to “Capacity Mode” by default.

### Single module systems up to 20HP

The new design makes it possible to use single module configurations for 45 (16HP), 50 (18HP) and 56 kW (20HP) systems, reducing space usage by 30%.



### Smaller, lighter design

The new design optimises dimensions and weight, and the new units are significantly more compact and lighter than the previous outdoor unit series (YJM). Weight savings of up to 126 Kg have been achieved for 45 (16HP), 50 (18HP) and 56 kW (20HP) systems.





### Emergency backup function

Y Series (Ecostandard, Nominal and Seasonal) and R2 Series (Nominal and Seasonal) combined modules offer unparalleled reliability with the new emergency backup function, which is easily activated from the remote control of any indoor unit in the event of a system malfunction.

The backup function allows the system to continue operating in heating and cooling mode for an average period of 4 hours.



### Rotation function

Y Series (Ecostandard, Nominal and Seasonal) and R2 Series (Nominal and Seasonal) combined modules use an automatic "Rotation Function" routine which optimises the usage of indoor and outdoor units to extend the lifespan of all system components.



### Easy maintenance

With the exclusive Uninterrupted Operation System of **M-Net Power** indoor units, if any of the indoor units is subject to maintenance, the other units in the installation continue to function without the system stopping.

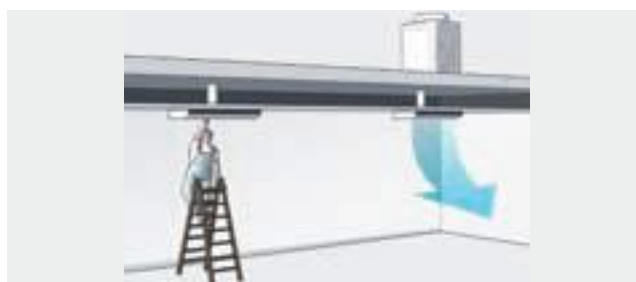

### Self-diagnosis of VRF CITY MULTI system

For even simpler maintenance, CITY MULTI systems have a self-diagnostic function which is capable of communicating malfunctions on different levels using fault codes. With the special Maintenance Tool software developed by Mitsubishi Electric, the user can connect to any point in the transmission line to acquire all technical operating information interactively.



### No central heating boilers necessary

The modularity of VRF CITY MULTI systems means that it is not necessary to include dedicated central heating boilers in the planning stage. These systems make it possible to use all the space available efficiently and rationally. Using a VRF CITY MULTI system also **exempts** the designer and installer from **I.S.P.E.S.L. compliance requisites**, while the client, administrator or building manager **is not required to have periodic combustion tests** performed. As an added advantage, the owner or user is not subject to legislative **seasonal usage limitations (especially in winter)**, meaning that the installation can be used whenever required for total comfort.



# Y heat pump outdoor units

## R2 heat recovery outdoor units



### Continuous Heating

The new **Y Series (Nominal and Seasonal)** and **R2 Series (Nominal and Seasonal)** outdoor units deliver continuous heating during defrost mode, resolving a typical shortcoming of heat pumps: interrupted heat delivery while the unit is operating in defrost mode. In a conventional unit, the defrost cycle – the duration of which depends on external weather conditions – inevitably affects indoor comfort. Mitsubishi Electric has implemented specific technology to achieve this, enabling split operation of the thermal exchange coil.

**Hot Gas Defrost** – This is an uninterrupted heating system based on split coil operation, which allows the unit to perform the defrost cycle in parallel while maintaining up to 50% of the nominal heating capacity of the system at outdoor air temperatures as low as  $-5^{\circ}\text{C}$ .

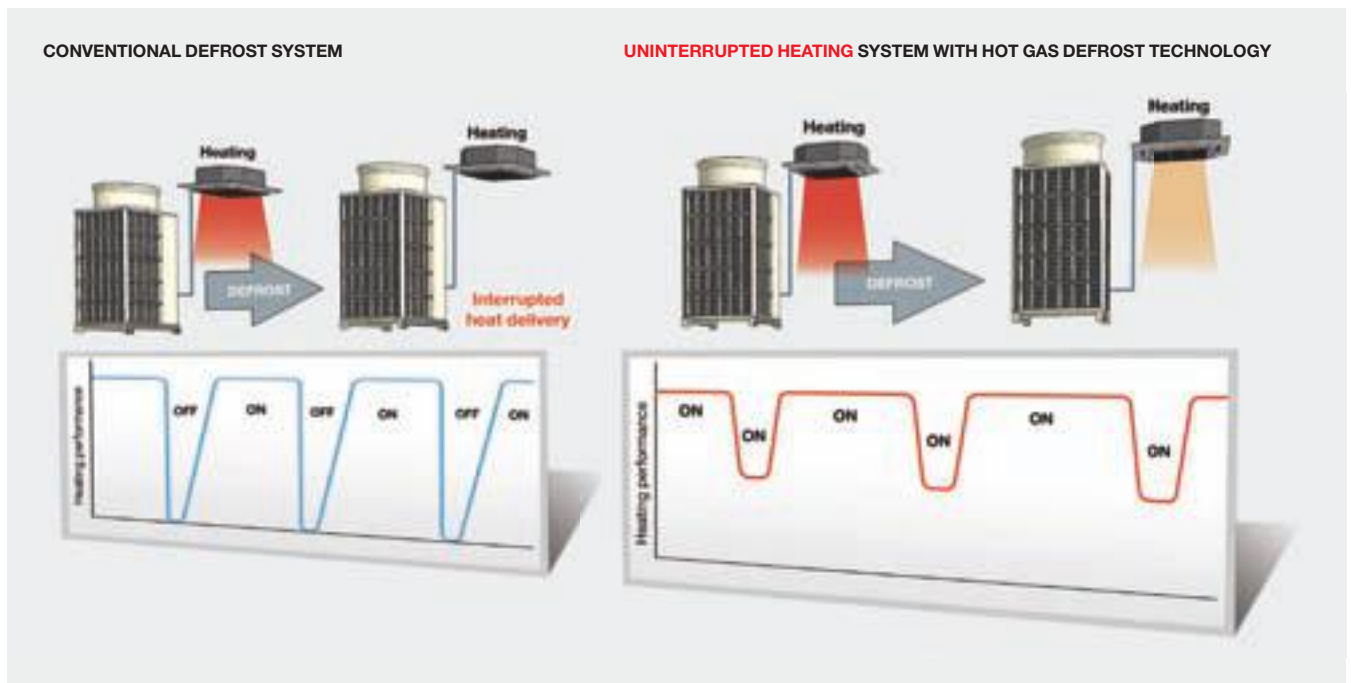

In double or triple module configurations, the continuous heating function is split between the modules, depending on the number of outdoor units in the system.

### Continuous heating – single module

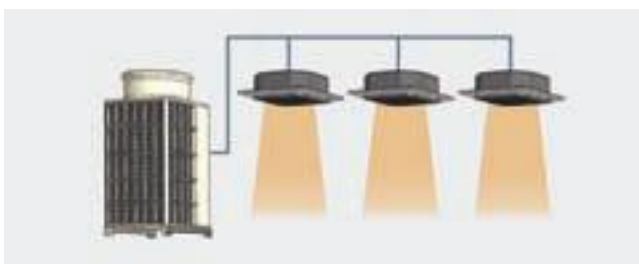

- The thermal exchange coil is split into 2 sections
- One section defrosts
- The other section continues to heat the indoor space via the indoor units
- **The Hot Gas Defrost** function is operative at outdoor air temperatures as low as  $1^{\circ}\text{C}$
- At lower temperatures, the conventional Reverse Defrost function is implemented.

### Continuous heating – modular system



- Double or triple modules
- One module defrosts
- The other modules continue to heat the indoor space via the indoor units
- In modular configuration systems, **the Hot Gas Defrost** function is operative at outdoor air temperatures as low as  $-5^{\circ}\text{C}$
- At lower temperatures, the conventional Reverse Defrost function is implemented.



# Exclusive characteristics of the Y and R2 Seasonal ranges of outdoor units



## Class-beating performance all year round

The new **Y Seasonal** and **R2 Seasonal series** outdoor units have been conceived to achieve the highest possible SCOP (Seasonal-COP) and SEER (Seasonal-EER) values.

These two parameters express the efficiency of a system over an entire season, and offer a very accurate picture of the real-world performance of the machine throughout its life cycle. In its commitment to continuously advancing technology, Mitsubishi Electric has created the new Y Seasonal and R2 Seasonal series of outdoor units, redefining yet again the state of the art in VRF technology and going beyond the concept of performance and efficiency in nominal conditions only to offer a highly evolved system whose true strength is its real-world performance.

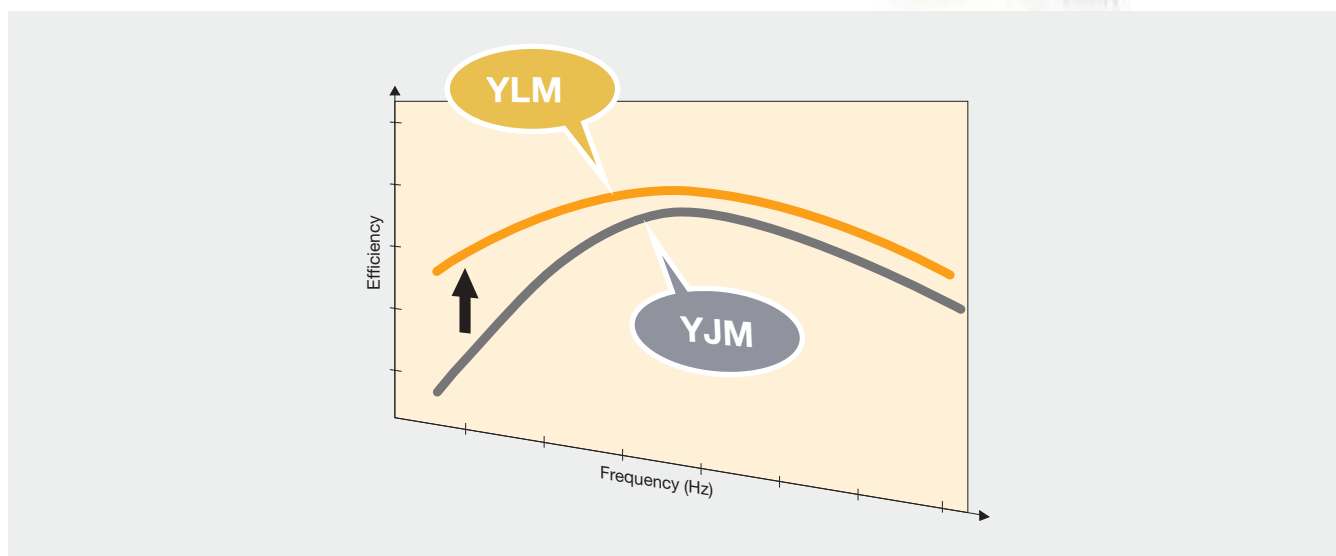

## New BSCC refrigeration circuit

The new **Y Seasonal** and **R2 Seasonal** range of outdoor units introduces the new, higher performance **Bottom SubCool Circuit (BSCC)** refrigeration circuit.

The new circuit transfers R410A gas from the top of the heat exchanger to the bottom, causing large volumes of refrigerant to flow through the upper portion of the outdoor unit. As this is where the air speed is higher, the result is improved thermal exchange.

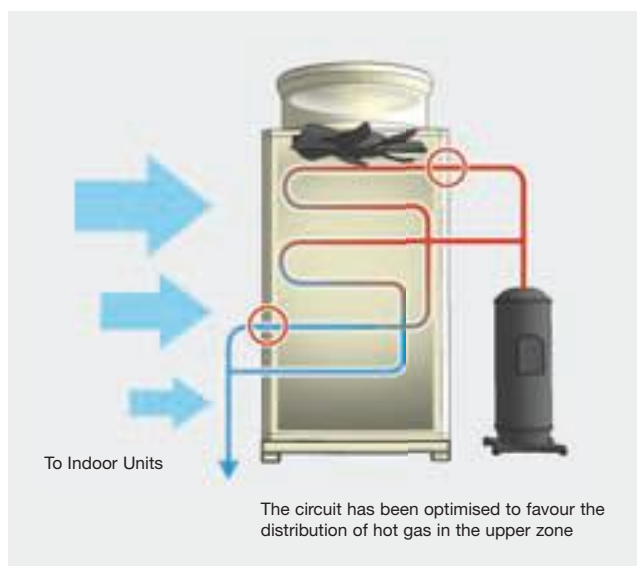

# Exclusive characteristics of the Y and R2

## Seasonal ranges of outdoor units



### FLAT TUBE thermal exchange coil

With the new **Y Seasonal** and **R2 Seasonal** series of outdoor units, Mitsubishi Electric has also introduced the new FLAT TUBE all-aluminium thermal exchange coil. The new solution, which is covered by global patents, sets new standards for heating and cooling performance while also reducing the overall size of the machine.

The FLAT TUBE technology coil – also known as a “micro-channel heat exchanger” – consists of three components: the flat tubing, the internal fins forming the micro-channels, and two refrigerant fluid collector boxes.

This type of heat exchanger was used for the first time in around 2008 in the automotive industry. With its globally patented FLAT TUBE system, Mitsubishi Electric has further developed this technology to offer even more advantages.

Unparalleled quality, efficiency and product integrity are the tangible results of a production process based on a single brazing stage instead of the 200-300 manually brazed individual connections necessary with a conventional copper/aluminium coil. Moreover, the FLAT TUBE heat exchanger requires a smaller charge volume than a conventional bi-metal coil, as the micro-channels limit the available volume for the refrigerant fluid while also creating a larger thermal exchange surface area.

**Weather resistance** is a key factor for the heat exchanger coil, as it is perhaps the component that is most exposed to the harmful effects of the atmosphere.

Here too, the **FLAT TUBE** coil outperforms other solutions: the single component in aluminium only is far less susceptible to corrosion than a conventional bi-metal coil in copper and aluminium. As if that were not already enough, the direct expansion coil of the new **Y Seasonal** and **R2 Seasonal** series outdoor units receive a special galvanic treatment with **sacrificial zinc anodes** to further prevent any possibility of corrosion, while a **waterproofing treatment** protects the copper pipes connecting the heat exchanger coil to the refrigeration circuit against electrolytic corrosion. A special version (denominated -BS) may be ordered for installations in highly saline conditions or coastal zones, which is specifically designed for these applications.

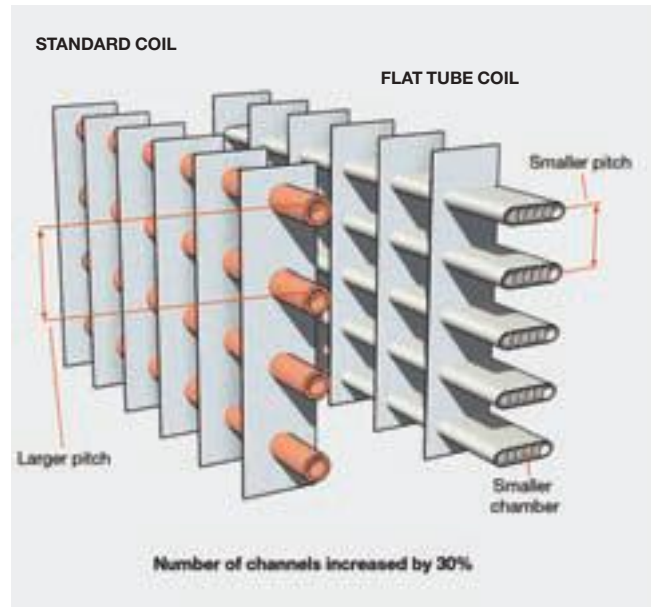

- ➔ +30% more piping
- ➔ +17% more Contact with Piping
- ➔ +26% more Contact with Refrigerant
- ➔ Smaller Pitch and Pipe Chamber
- ➔ Reduced Refrigerant Volume

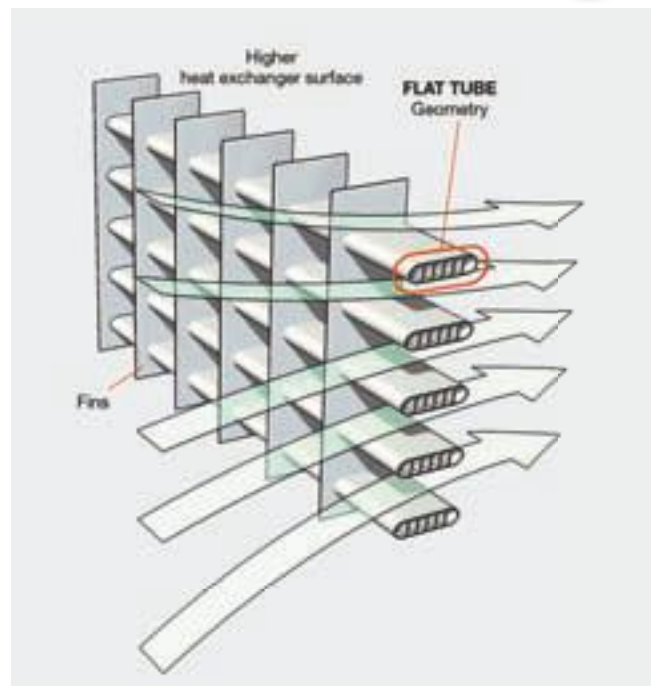



### Compressor: “Poki Poki” DC Inverter electric motor

Mitsubishi Electric has created an extremely compact and highly efficient DC Inverter electric motor. Named “Poki Poki”, this motor equips the compressors in **Y Series (Nominal and Seasonal) and R2 Series (Nominal and Seasonal)** outdoor units. The Mitsubishi Electric Poki Poki motor has a very high coil density which significantly increases efficiency.

Instead of a single core structure (as in the prior YHM series of outdoor units), the stator of the Poki Poki motor consists of multiple core segments. The coil is wound around each individual core segment (hence the denomination “High Density Winding”) to minimise dead space.

With a 20% higher volumetric density of the copper coil than a conventional electric motor, this motor is 4% more efficient.

The Poki Poki motor saves energy and reduces CO2 emissions while offering greater durability and reliability. This technology is used on a massive scale by Mitsubishi Electric in automotive applications, elevators and escalators.



### Compressor: new induction heating technology

The new **Y Seasonal and R2 Seasonal** outdoor units employ a pre-heating system for the scroll compressor based on **induction technology**. This solution is used to warm the compressor housing to minimise energy absorption in stand-by state. Yet another solution contributing to reducing energy consumption.



### Compressor: new DC Scroll Inverter compressor

The new DC Scroll Inverter compressor represents the state of the art in scroll compressor technology and is the jewel in the crown of the new ranges introduced by Mitsubishi Electric. The technical improvements implemented to the new compressor increase efficiency, especially at low operating frequencies, offering a significant advantage in terms of energy consumption in the real-world operation of the machine (SEER, SCOP), and not just in nominal conditions.



# Series Y Ecostandard single



PUHY-P YKA OUTDOOR UNITS  
OPTIMISED FOR COOLING PERFORMANCE

E.T.C.



## TECHNICAL SPECIFICATIONS

MODEL			PUHY-P200YKA(-BS)	PUHY-P250YKA(-BS)
<b>HP</b>			8	10
<b>Power</b>	Voltage/Freq./Phases	V/Hz/n°	3 phase 380-400-415V 50Hz	3 phase 380-400-415V 50Hz
<b>Cooling</b>	Nominal capacity <sup>1</sup>	kW	22.4	28.0
	Power absorption	kW	5.19	6.89
	EER		4.31	4.06
	Operating temperature range	Indoor WB °C Outdoor DB °C	15.0~24.0 -5.0~52.0	15.0~24.0 -5.0~52.0
<b>Heating</b>	Nominal capacity <sup>2</sup>	kW	22.4	28.0
	Power absorption	kW	5.05	6.33
	COP		4.43	4.42
	Operating temperature range	Indoor DB °C Outdoor WB °C	15.0~27.0 -20.0~15.5	15.0~27.0 -20.0~15.5
<b>Sound pressure<sup>3</sup></b>			57	58
<b>Connectable indoor units</b>	Total capacity		50 to 130% of capacity of O.U.	50 to 130% of capacity of O.U.
	Model/Quantity		P15~P250/1~17	P15~P250/1~21
<b>External diameter of refrigerant connectors</b>	Liquid	mm	9.52	9.52
	Gas	mm	22.2	22.2
	Fan air flow rate	m <sup>3</sup> /min	175	175
	External dimensions (HxLxW)	mm	1650 x 920 x 740	1650 x 920 x 740
	Net weight	kg	195	195
	R410A refrigerant charge quantity	kg	8.0	8.0

## TECHNICAL SPECIFICATIONS

MODEL			PUHY-P300YKA(-BS)	PUHY-P350YKA(-BS)
<b>HP</b>			12	14
<b>Power</b>	Voltage/Freq./Phases	V/Hz/n°	3 phase 380-400-415V 50Hz	3 phase 380-400-415V 50Hz
<b>Cooling</b>	Nominal capacity <sup>1</sup>	kW	33.5	40.0
	Power absorption	kW	8.86	11.69
	EER		3.78	3.42
	Operating temperature range	Indoor WB °C Outdoor DB °C	15.0~24.0 -5.0~52.0	15.0~24.0 -5.0~52.0
<b>Heating</b>	Nominal capacity <sup>2</sup>	kW	33.5	40.0
	Power absorption	kW	8.11	9.61
	COP		4.13	4.16
	Operating temperature range	Indoor DB °C Outdoor WB °C	15.0~27.0 -20.0~15.5	15.0~27.0 -20.0~15.5
<b>Sound pressure<sup>3</sup></b>			61	61
<b>Connectable indoor units</b>	Total capacity		50 to 130% of capacity of O.U.	50 to 130% of capacity of O.U.
	Model/Quantity		P15~P250/1~26	P15~P250/1~30
<b>External diameter of refrigerant connectors</b>	Liquid	mm	9.52	12.7
	Gas	mm	22.2	28.58
	Fan air flow rate	m <sup>3</sup> /min	185	210
	External dimensions (HxLxW)	mm	1650 x 920 x 740	1650 x 1220 x 740
	Net weight	kg	211	256
	R410A refrigerant charge quantity	kg	8.0	11.5

\*1 Nominal cooling conditions: Indoor 27°C DB / 19°C WB, Outdoor 35°C DB, Piping length 7.5 m, vertical difference 0 m.

\*2 Nominal heating conditions: Indoor 20°C DB, Outdoor 7°C DB / 6°C WB, Piping length 7.5 m, vertical difference 0 m.

\*3 Values measured in anechoic chamber.

PUHY-P YKA OUTDOOR UNITS  
OPTIMISED FOR COOLING PERFORMANCE

E.T.C.

NEW



## TECHNICAL SPECIFICATIONS

MODEL			PUHY-P400YKA(-BS)	PUHY-P450YKA(-BS)
<b>HP</b>			16	18
<b>Power</b>	Voltage/Freq./Phases	V/Hz/n°	3-phase 4-wire 380-400-415 V 50/60 Hz	
<b>Cooling</b>	Nominal capacity <sup>1</sup>	kW	45.0	48.0
	Power absorption	kW	13.55	15.78
	EER		3.32	3.04
	Operating temperature range	Indoor WB °C	15.0~24.0	15.0~24.0
	Outdoor DB °C	-5.0~52.0	-5.0~52.0	
<b>Heating</b>	Nominal capacity <sup>2</sup>	kW	45.0	48.0
	Power absorption	kW	10.92	13.33
	COP		4.12	3.60
	Operating temperature range	Indoor DB °C	15.0~27.0	15.0~27.0
	Outdoor WB °C	-20.0~15.5	-20.0~15.5	
<b>Sound pressure<sup>3</sup></b>			dB(A)	
<b>Connectable indoor units</b>			50~130% of outdoor unit capacity	
Total capacity			50~130% of outdoor unit capacity	
Model/Quantity			P15~P250/1~34	
<b>External diameter of refrigerant connectors</b>			P15~P250/1~39	
Liquid			mm	
Gas			mm	
Fan air flow rate			m <sup>3</sup> /min	
External dimensions (HxLxW)			mm	
Net weight			kg	
R410A refrigerant charge quantity			kg	

## TECHNICAL SPECIFICATIONS

MODEL			PUHY-P500YKA
<b>HP</b>			20
<b>Power</b>	Voltage/Freq./Phases	V/Hz/n°	3-phase 4-wire 380-400-415 V 50/60 Hz
<b>Cooling</b>	Nominal capacity <sup>1</sup>	kW	55.0
	Power absorption	kW	18.39
	EER		2.99
	Operating temperature range	Indoor WB °C	15.0~24.0
	Outdoor DB °C	-5.0~52.0	
<b>Heating</b>	Nominal capacity <sup>2</sup>	kW	55.0
	Power absorption	kW	15.71
	COP		3.50
	Operating temperature range	Indoor DB °C	15.0~27.0
	Outdoor WB °C	-20.0~15.5	
<b>Sound pressure<sup>3</sup></b>			65
<b>Connectable indoor units</b>			50~130% of outdoor unit capacity
Total capacity			50~130% of outdoor unit capacity
Model/Quantity			P15~P250/1~43
<b>External diameter of refrigerant connectors</b>			P15~P250/1~43
Liquid			mm
Gas			mm
Fan air flow rate			m <sup>3</sup> /min
External dimensions (HxLxW)			mm
Net weight			kg
R410A refrigerant charge quantity			kg

<sup>1</sup> Nominal cooling conditions: Indoor 27°C DB / 19°C WB, Outdoor 35°C DB. Piping length 7.5 m, vertical difference 0 m.

<sup>2</sup> Nominal heating conditions: Indoor 20°C DB. Outdoor 7°C DB / 6°C WB. Piping length 7.5 m, vertical difference 0 m.

<sup>3</sup> Values measured in anechoic chamber.

# Series Y Ecostandard double



PUHY-P YSKA OUTDOOR UNITS  
OPTIMISED FOR COOLING PERFORMANCE

E.T.C.



## TECHNICAL SPECIFICATIONS

MODEL			PUHY-P550YSKA(-BS)	PUHY-P600YSKA(-BS)	PUHY-P650YSKA(-BS)		
<b>HP</b>			22	24	26		
<b>Power</b>	Voltage/Freq./Phases	V/Hz/n°	3 phase 380-400-415V 50Hz			3 phase 380-400-415V 50Hz	
<b>Cooling</b>	Nominal capacity <sup>1</sup>	kW	63.0	68.0	73.0		
	Power absorption	kW	16.07	18.18	19.78		
	EER		3.92	3.74	3.69		
	Operating temperature range	Indoor WB °C Outdoor DB °C	15.0~24.0 -5.0~52.0	15.0~24.0 -5.0~52.0	15.0~24.0 -5.0~52.0		
<b>Heating</b>	Nominal capacity <sup>2</sup>	kW	63.0	68.0	73.0		
	Power absorption	kW	15.51	16.70	18.02		
	COP		4.06	4.07	4.05		
	Operating temperature range	Indoor DB °C Outdoor WB °C	15.0~27.0 -20.0~15.5	15.0~27.0 -20.0~15.5	15.0~27.0 -20.0~15.5		
<b>Sound pressure<sup>3</sup></b>			63		64.5		
<b>Connectable indoor units</b>	Total capacity		50~130% of outdoor unit capacity		50~130% of outdoor unit capacity		
	Model/Quantity		P15~P250/2~47		P15~P250/2~50		
<b>External diameter of refrigerant connectors</b>	Liquid	mm	15.88		15.88		
	Gas	mm	28.58		28.58		
<b>Model</b>			PUHY-P250YKA	PUHY-P300YKA	PUHY-P250YKA	PUHY-P400YKA	
	Fan air flow rate	m³/min	175	185	175	210	
	External dimensions (HxLxW)	mm	1650 x 920 x 740	1650 x 920 x 740	1650 x 920 x 740	1650 x 1220 x 740	
	Net weight	kg	195	211	195	253	
	R410A refrigerant charge quantity	kg	8.0	8.0	8.0	11.5	

## TECHNICAL SPECIFICATIONS



MODEL			PUHY-P700YSKA(-BS)	PUHY-P750YSKA(-BS)	PUHY-P800YSKA(-BS)		
<b>HP</b>			28	30	32		
<b>Power</b>	Voltage/Freq./Phases	V/Hz/n°	3 phase 380-400-415V 50Hz			3 phase 380-400-415V 50Hz	
<b>Cooling</b>	Nominal capacity <sup>1</sup>	kW	76.0	81.5	90.0		
	Power absorption	kW	21.40	23.90	27.10		
	EER		3.55	3.41	3.32		
	Operating temperature range	Indoor WB °C Outdoor DB °C	15.0~24.0 -5.0~52.0	15.0~24.0 -5.0~52.0	15.0~24.0 -5.0~52.0		
<b>Heating</b>	Nominal capacity <sup>2</sup>	kW	76.0	81.5	90.0		
	Power absorption	kW	20.00	22.20	23.01		
	COP		3.80	3.67	3.91		
	Operating temperature range	Indoor DB °C Outdoor WB °C	15.0~27.0 -20.0~15.5	15.0~27.0 -20.0~15.5	15.0~27.0 -20.0~15.5		
<b>Sound pressure<sup>3</sup></b>			64.5		66		
<b>Connectable indoor units</b>	Total capacity		50~130% of outdoor unit capacity		50~130% of outdoor unit capacity		
	Model/Quantity		P15~P250/2~50		P15~P250/2~50		
<b>External diameter of refrigerant connectors</b>	Liquid	mm	19.05		19.05		
	Gas	mm	34.93		34.93		
<b>Model</b>			PUHY-P250YKA	PUHY-P450YKA	PUHY-P300YKA	PUHY-P400YKA	
	Fan air flow rate	m³/min	175	210	185	210	
	External dimensions (HxLxW)	mm	1650 x 920 x 740	1650 x 1220 x 740	1650 x 920 x 740	1650 x 1220 x 740	
	Net weight	kg	195	253	211	253	
	R410A refrigerant charge quantity	kg	8.0	11.5	8.0	11.5	

\*1 Nominal cooling conditions: Indoor 27°C DB / 19°C WB, Outdoor 35°C DB, Piping length 7.5 m, vertical difference 0 m.

\*2 Nominal heating conditions: Indoor 20°C DB, Outdoor 7°C DB / 6°C WB, Piping length 7.5 m, vertical difference 0 m.

\*3 Values measured in anechoic chamber.

# Series Y Ecostandard double



PUHY-P YSKA OUTDOOR UNITS  
OPTIMISED FOR COOLING PERFORMANCE

E.T.C.

NEW



## TECHNICAL SPECIFICATIONS

MODEL			PUHY-P850YSKA(-BS)	PUHY-P900YSKA(-BS)		
<b>HP</b>			34	36		
<b>Power</b>	Voltage/Freq./Phases	V/Hz/n°	3 phase 380-400-415V 50Hz			
<b>Cooling</b>	Nominal capacity <sup>1</sup>	kW	93.0	96.0		
	Power absorption	kW	29.24	31.57		
	EER		3.18	3.04		
	Operating temperature range	Indoor WB °C Outdoor DB °C	15.0~24.0 -5.0~52.0	15.0~24.0 -5.0~52.0		
<b>Heating</b>	Nominal capacity <sup>2</sup>	kW	93.0	96.0		
	Power absorption	kW	25.40	28.07		
	COP		3.66	3.42		
	Operating temperature range	Indoor DB °C Outdoor WB °C	15.0~27.0 -20.0~15.5	15.0~27.0 -20.0~15.5		
<b>Sound pressure<sup>3</sup></b>			66	66		
<b>Connectable indoor units</b>	Total capacity		50~130% of outdoor unit capacity			
	Model/Quantity		P15~P250/2~50			
<b>External diameter of refrigerant connectors</b>	Liquid	mm	19.05			
	Gas	mm	41.28			
<b>Model</b>			PUHY-P400YKA	PUHY-P450YKA	PUHY-P450YKA	PUHY-P450YKA
	Fan air flow rate	m³/min	210	210	210	210
	External dimensions (HxLxW)	mm	1650 x 1220 x 740	1650 x 1220 x 740	1650 x 1220 x 740	1650 x 1220 x 740
	Net weight	kg	253	253	253	253
	R410A refrigerant charge quantity	kg	11.5	11.5	11.5	11.5

## TECHNICAL SPECIFICATIONS



MODEL			PUHY-P950YSKA(-BS)	PUHY-P1000YSKA(-BS)		
<b>HP</b>			38	40		
<b>Power</b>	Voltage/Freq./Phases	V/Hz/n°	3 phase 380-400-415V 50Hz			
<b>Cooling</b>	Nominal capacity <sup>1</sup>	kW	103.0	110.0		
	Power absorption	kW	34.21	36.78		
	EER		3.01	2.99		
	Operating temperature range	Indoor WB °C Outdoor DB °C	15.0~24.0 -5.0~52.0	15.0~24.0 -5.0~52.0		
<b>Heating</b>	Nominal capacity <sup>2</sup>	kW	103.0	110.0		
	Power absorption	kW	30.56	33.13		
	COP		3.37	3.32		
	Operating temperature range	Indoor DB °C Outdoor WB °C	15.0~27.0 -20.0~15.5	15.0~27.0 -20.0~15.5		
<b>Sound pressure<sup>3</sup></b>			67.5	68		
<b>Connectable indoor units</b>	Total capacity		50~130% of outdoor unit capacity			
	Model/Quantity		P15~P250/2~50			
<b>External diameter of refrigerant connectors</b>	Liquid	mm	19.05			
	Gas	mm	41.28			
<b>Model</b>			PUHY-P450YKA	PUHY-P500YKA	PUHY-P500YKA	PUHY-P500YKA
	Fan air flow rate	m³/min	210	360	360	360
	External dimensions (HxLxW)	mm	1650 x 1220 x 740	1650 x 1750 x 740	1650 x 1750 x 740	1650 x 1750 x 740
	Net weight	kg	253	288	288	288
	R410A refrigerant charge quantity	kg	11.5	11.8	11.8	11.8

<sup>1</sup> Nominal cooling conditions: Indoor 27°C DB / 19°C WB, Outdoor 35°C DB. Piping length 7.5 m, vertical difference 0 m.

<sup>2</sup> Nominal heating conditions: Indoor 20°C DB. Outdoor 7°C DB / 6°C WB. Piping length 7.5 m, vertical difference 0 m.

<sup>3</sup> Values measured in anechoic chamber.

# Series Y Ecostandard triple



PUHY-P YSKA OUTDOOR UNITS  
OPTIMISED FOR COOLING PERFORMANCE

E.T.C.



## TECHNICAL SPECIFICATIONS

MODEL			PUHY-P1050YSKA(-BS)			PUHY-P1100YSKA(-BS)		
<b>HP</b>			42			44		
<b>Power</b>	Voltage/Freq./Phases	V/Hz/n°	3 phase 380-400-415V 50Hz			3 phase 380-400-415V 50Hz		
<b>Cooling</b>	Nominal capacity <sup>1</sup>	kW	115.0			121.5		
	Power absorption	kW	32.57			35.63		
	EER		3.53			3.41		
	Operating temperature range	Indoor WB °C Outdoor DB °C	15.0~24.0 -5.0~52.0			15.0~24.0 -5.0~52.0		
<b>Heating</b>	Nominal capacity <sup>2</sup>	kW	115.0			121.5		
	Power absorption	kW	31.50			33.80		
	COP		3.65			3.59		
	Operating temperature range	Indoor DB °C Outdoor WB °C	15.0~27.0 -20.0~15.5			15.0~27.0 -20.0~15.5		
<b>Sound pressure<sup>3</sup></b>			66.5			66.5		
<b>Connectable indoor units</b>	Total capacity	50~130% of outdoor unit capacity						
	Model/Quantity	P15~P250/2~50			P15~P250/2~50			
<b>External diameter of refrigerant connectors</b>	Liquid	mm	19.05			19.05		
	Gas	mm	41.28			41.28		
<b>Model</b>			PUHY-P300YKA	PUHY-P300YKA	PUHY-P450YKA	PUHY-P300YKA	PUHY-P350YKA	PUHY-P450YKA
	Fan air flow rate	m³/min	185	185	210	185	210	210
	External dimensions (HxLxW)	mm	1650 x 920 x 740	1650 x 920 x 740	1650 x 1220 x 740	1650 x 920 x 740	1650 x 1220 x 740	1650 x 1220 x 740
	Net weight	kg	211	211	253	211	256	253
	R410A refrigerant charge quantity	kg	8.0	8.0	11.5	8.0	11.5	11.5

## TECHNICAL SPECIFICATIONS

MODEL			PUHY-P1150YSKA(-BS)			PUHY-P1200YSKA(-BS)		
<b>HP</b>			46			48		
<b>Power</b>	Voltage/Freq./Phases	V/Hz/n°	3 phase 380-400-415V 50Hz			3 phase 380-400-415V 50Hz		
<b>Cooling</b>	Nominal capacity <sup>1</sup>	kW	130.0			135.0		
	Power absorption	kW	38.80			40.66		
	EER		3.35			3.32		
	Operating temperature range	Indoor WB °C Outdoor DB °C	15.0~24.0 -5.0~52.0			15.0~24.0 -5.0~52.0		
<b>Heating</b>	Nominal capacity <sup>2</sup>	kW	130.0			135.0		
	Power absorption	kW	35.51			37.70		
	COP		3.66			3.58		
	Operating temperature range	Indoor DB °C Outdoor WB °C	15.0~27.0 -20.0~15.5			15.0~27.0 -20.0~15.5		
<b>Sound pressure<sup>3</sup></b>			67.5			68		
<b>Connectable indoor units</b>	Total capacity	50~130% of outdoor unit capacity						
	Model/Quantity	P15~P250/2~50			P15~P250/2~50			
<b>External diameter of refrigerant connectors</b>	Liquid	mm	19.05			19.05		
	Gas	mm	41.28			41.28		
<b>Model</b>			PUHY-P350YKA	PUHY-P400YKA	PUHY-P400YKA	PUHY-P400YKA	PUHY-P400YKA	PUHY-P400YKA
	Fan air flow rate	m³/min	210	210	210	210	210	210
	External dimensions (HxLxW)	mm	1650 x 1220 x 740	1650 x 1220 x 740	1650 x 1220 x 740	1650 x 1220 x 740	1650 x 1220 x 740	1650 x 1220 x 740
	Net weight	kg	256	253	253	253	253	253
	R410A refrigerant charge quantity	kg	11.5	11.5	11.5	11.5	11.5	11.5

\*1 Nominal cooling conditions: Indoor 27°C DB / 19°C WB, Outdoor 35°C DB, Piping length 7.5 m, vertical difference 0 m.

\*2 Nominal heating conditions: Indoor 20°C DB, Outdoor 7°C DB / 6°C WB, Piping length 7.5 m, vertical difference 0 m.

\*3 Values measured in anechoic chamber.



# Series Y Ecostandard triple



PUHY-P YSKA OUTDOOR UNITS  
OPTIMISED FOR COOLING PERFORMANCE

E.T.C.

NEW



## TECHNICAL SPECIFICATIONS

MODEL			PUHY-P1250YSKA(-BS)			PUHY-P1300YSKA(-BS)		
<b>HP</b>			50			52		
<b>Power</b>	Voltage/Freq./Phases	V/Hz/n°	3 phase 380-400-415V 50Hz			3 phase 380-400-415V 50Hz		
<b>Cooling</b>	Nominal capacity <sup>1</sup>	kW	138.0			141.0		
	Power absorption	kW	43.12			45.77		
	EER		3.20			3.08		
	Operating temperature range	Indoor WB °C Outdoor DB °C	15.0~24.0 -5.0~52.0			15.0~24.0 -5.0~52.0		
<b>Heating</b>	Nominal capacity <sup>2</sup>	kW	138.0			141.0		
	Power absorption	kW	40.35			42.98		
	COP		3.42			3.28		
	Operating temperature range	Indoor DB °C Outdoor WB °C	15.0~27.0 -20.0~15.5			15.0~27.0 -20.0~15.5		
<b>Sound pressure<sup>3</sup></b>			68			68		
<b>Connectable indoor units</b>	Total capacity	50~130% of outdoor unit capacity			50~130% of outdoor unit capacity			
	Model/Quantity	P15~P250/2~50			P15~P250/2~50			
<b>External diameter of refrigerant connectors</b>	Liquid	mm	19.05			19.05		
	Gas	mm	41.28			41.28		
<b>Model</b>			PUHY-P400YKA	PUHY-P400YKA	PUHY-P450YKA	PUHY-P400YKA	PUHY-P450YKA	PUHY-P450YKA
	Fan air flow rate	m <sup>3</sup> /min	210	210	210	210	210	210
	External dimensions (HxLxW)	mm	1650 x 1220 x 740	1650 x 1220 x 740	1650 x 1220 x 740	1650 x 1220 x 740	1650 x 1220 x 740	1650 x 1220 x 740
	Net weight	kg	253	253	253	253	253	253
	R410A refrigerant charge quantity	kg	11.5	11.5	11.5	11.5	11.5	11.5

## TECHNICAL SPECIFICATIONS

MODEL			PUHY-P1350YSKA(-BS)			PUHY-P1400YSKA(-BS)		
<b>HP</b>			54			56		
<b>Power</b>	Voltage/Freq./Phases	V/Hz/n°	3 phase 380-400-415V 50Hz			3 phase 380-400-415V 50Hz		
<b>Cooling</b>	Nominal capacity <sup>1</sup>	kW	144.0			151.0		
	Power absorption	kW	48.64			52.24		
	EER		2.96			2.89		
	Operating temperature range	Indoor WB °C Outdoor DB °C	15.0~24.0 -5.0~52.0			15.0~24.0 -5.0~52.0		
<b>Heating</b>	Nominal capacity <sup>2</sup>	kW	144.0			151.0		
	Power absorption	kW	46.15			49.50		
	COP		3.12			3.05		
	Operating temperature range	Indoor DB °C Outdoor WB °C	15.0~27.0 -20.0~15.5			15.0~27.0 -20.0~15.5		
<b>Sound pressure<sup>3</sup></b>			68			68.5		
<b>Connectable indoor units</b>	Total capacity	50~130% of outdoor unit capacity			50~130% of outdoor unit capacity			
	Model/Quantity	P15~P250/2~50			P15~P250/2~50			
<b>External diameter of refrigerant connectors</b>	Liquid	mm	19.05			19.05		
	Gas	mm	41.28			41.28		
<b>Model</b>			PUHY-P450YKA	PUHY-P450YKA	PUHY-P450YKA	PUHY-P450YKA	PUHY-P450YKA	PUHY-P500YKA
	Fan air flow rate	m <sup>3</sup> /min	210	210	210	210	210	360
	External dimensions (HxLxW)	mm	1650 x 1220 x 740	1650 x 1220 x 740	1650 x 1220 x 740	1650 x 1220 x 740	1650 x 1220 x 740	1650 x 1750 x 740
	Net weight	kg	253	253	253	253	253	288
	R410A refrigerant charge quantity	kg	11.5	11.5	11.5	11.5	11.5	11.8

<sup>1</sup> Nominal cooling conditions: Indoor 27°C DB / 19°C WB, Outdoor 35°C DB. Piping length 7.5 m, vertical difference 0 m.

<sup>2</sup> Nominal heating conditions: Indoor 20°C DB. Outdoor 7°C DB / 6°C WB. Piping length 7.5 m, vertical difference 0 m.

<sup>3</sup> Values measured in anechoic chamber.

# Series Y Ecostandard triple



PUHY-P YSKA OUTDOOR UNITS  
OPTIMISED FOR COOLING PERFORMANCE

E.T.C.



## TECHNICAL SPECIFICATIONS

MODEL			PUHY-P1450YSKA(-BS)			PUHY-P1500YSKA(-BS)		
<b>HP</b>			58			60		
<b>Power</b>			3 phase 380-400-415V 50Hz			3 phase 380-400-415V 50Hz		
<b>Cooling</b>	Voltage/Freq./Phases		V/Hz/n°					
	Nominal capacity <sup>1</sup>		kW		158.0			
	Power absorption		kW		55.83			
	EER				2.83			
<b>Heating</b>	Operating temperature range		Indoor WB °C		15.0~24.0			
			Outdoor DB °C		-5.0~52.0			
	Nominal capacity <sup>2</sup>		kW		158.0			
	Power absorption		kW		52.49			
COP				3.01				
<b>Sound pressure<sup>3</sup></b>	Operating temperature range		Indoor DB °C		15.0~27.0			
			Outdoor WB °C		-20.0~15.5			
<b>Connectable indoor units</b>			50~130% of outdoor unit capacity			50~130% of outdoor unit capacity		
Total capacity								
Model/Quantity			P15~P250/2~50			P15~P250/2~50		
<b>External diameter of refrigerant connectors</b>	Liquid		mm		19.05			
	Gas		mm		41.28			
<b>Model</b>			PUHY-P450YKA	PUHY-P500YKA	PUHY-P500YKA	PUHY-P500YKA	PUHY-P500YKA	PUHY-P500YKA
Fan air flow rate			m <sup>3</sup> /min		210			
External dimensions (HxLxW)			mm		1650 x 1220 x 740			
Net weight			kg		253			
R410A refrigerant charge quantity			kg		11.5			

\*1 Nominal cooling conditions: Indoor 27°C DB / 19°C WB, Outdoor 35°C DB, Piping length 7.5 m, vertical difference 0 m.

\*2 Nominal heating conditions: Indoor 20°C DB, Outdoor 7°C DB / 6°C WB, Piping length 7.5 m, vertical difference 0 m.

\*3 Values measured in anechoic chamber.



# Series Y Nominal single



PUHY-P YKB-A1 OUTDOOR UNITS  
OPTIMISED FOR NOMINAL PERFORMANCE

E.T.C.

CONTINUOUS HEATING

## TECHNICAL SPECIFICATIONS

MODEL			PUHY-P200YKB-A1(-BS)	PUHY-P250YKB-A1(-BS)
<b>HP</b>			8	10
<b>Power</b>	Voltage/Freq./Phases	V/Hz/n°	3 phase 380-400-415V 50Hz	3 phase 380-400-415V 50Hz
<b>Cooling</b>	Nominal capacity <sup>1</sup>	kW	22.4	28.0
	Power absorption	kW	5.19	6.88
	EER		4.31	4.06
	Operating temperature range	Indoor WB °C Outdoor DB °C	15.0~24.0 -5.0~52.0	15.0~24.0 -5.0~52.0
<b>Heating</b>	Nominal capacity <sup>2</sup>	kW	25.0	31.5
	Power absorption	kW	5.81	7.34
	COP		4.30	4.29
	Operating temperature range	Indoor DB °C Outdoor WB °C	15.0~27.0 -20.0~15.5	15.0~27.0 -20.0~15.5
<b>Sound pressure<sup>3</sup></b>			57	59
<b>Connectable indoor units</b>	Total capacity		50 to 130% of capacity of O.U.	50 to 130% of capacity of O.U.
	Model/Quantity		P15~P250/1~17	P15~P250/1~21
<b>External diameter of refrigerant connectors</b>	Liquid	mm	9.52	9.52
	Gas	mm	22.2	22.2
	Fan air flow rate	m <sup>3</sup> /min	175	175
External dimensions (HxLxW)		mm	1710 x 920 x 740	1710 x 920 x 740
Net weight		kg	190	199
R410A refrigerant charge quantity		kg	6.5	8.0

## TECHNICAL SPECIFICATIONS

MODEL			PUHY-P300YKB-A1(-BS)	PUHY-P350YKB-A1(-BS)
<b>HP</b>			12	14
<b>Power</b>	Voltage/Freq./Phases	V/Hz/n°	3 phase 380-400-415V 50Hz	3 phase 380-400-415V 50Hz
<b>Cooling</b>	Nominal capacity <sup>1</sup>	kW	33.5	40.0
	Power absorption	kW	8.56	11.69
	EER		3.91	3.42
	Operating temperature range	Indoor WB °C Outdoor DB °C	15.0~24.0 -5.0~52.0	15.0~24.0 -5.0~52.0
<b>Heating</b>	Nominal capacity <sup>2</sup>	kW	37.5	45.0
	Power absorption	kW	9.07	11.13
	COP		4.13	4.04
	Operating temperature range	Indoor DB °C Outdoor WB °C	15.0~27.0 -20.0~15.5	15.0~27.0 -20.0~15.5
<b>Sound pressure<sup>3</sup></b>			61	61
<b>Connectable indoor units</b>	Total capacity		50 to 130% of capacity of O.U.	50 to 130% of capacity of O.U.
	Model/Quantity		P15~P250/1~26	P15~P250/1~30
<b>External diameter of refrigerant connectors</b>	Liquid	mm	9.52	12.7
	Gas	mm	22.2	28.58
	Fan air flow rate	m <sup>3</sup> /min	210	210
External dimensions (HxLxW)		mm	1710 x 1220 x 740	1710 x 1220 x 740
Net weight		kg	251	251
R410A refrigerant charge quantity		kg	11.5	11.5

\*1 Nominal cooling conditions: Indoor 27°C DB / 19°C WB, Outdoor 35°C DB, Piping length 7.5 m, vertical difference 0 m.

\*2 Nominal heating conditions: Indoor 20°C DB, Outdoor 7°C DB / 6°C WB, Piping length 7.5 m, vertical difference 0 m.

\*3 Values measured in anechoic chamber.

# Series Y Nominal double



PUHY-P YSKB-A1 OUTDOOR UNITS  
OPTIMISED FOR NOMINAL PERFORMANCE

E.T.C.

CONTINUOUS HEATING

OUTDOOR UNITS

## TECHNICAL SPECIFICATIONS

MODEL			PUHY-P400YSKB-A1(-BS)	PUHY-P450YSKB-A1(-BS)	PUHY-P500YSKB-A1(-BS)		
<b>HP</b>			16	18	20		
<b>Power</b>	Voltage/Freq./Phases	V/Hz/n°	3 phase 380-400-415V 50Hz	3 phase 380-400-415V 50Hz	3 phase 380-400-415V 50Hz		
<b>Cooling</b>	Nominal capacity <sup>1</sup>	kW	45.0	50.0	56.0		
	Power absorption	kW	11.0	12.59	14.54		
	EER		4.09	3.97	3.85		
	Operating temperature range	Indoor WB °C Outdoor DB °C	15.0~24.0 -5.0~52.0	15.0~24.0 -5.0~52.0	15.0~24.0 -5.0~52.0		
<b>Heating</b>	Nominal capacity <sup>2</sup>	kW	50.0	56.0	63.0		
	Power absorption	kW	12.24	13.72	15.46		
	COP		4.08	4.08	4.07		
	Operating temperature range	Indoor DB °C Outdoor WB °C	15.0~27.0 -20.0~15.5	15.0~27.0 -20.0~15.5	15.0~27.0 -20.0~15.5		
<b>Sound pressure<sup>3</sup></b>			60	61.5	62.0		
<b>Connectable indoor units</b>	Total capacity	50 to 130% of capacity of O.U.			50 to 130% of capacity of O.U.	50 to 130% of capacity of O.U.	
	Model/Quantity	P15~P250/1~34			P15~P250/1~39	P15~P250/1~43	
<b>External diameter of refrigerant connectors</b>	Liquid	mm	12.7	15.88	15.88		
	Gas	mm	28.58	28.58	28.58		
<b>Model</b>			PUHY-P200YKB-A1	PUHY-P200YKB-A1	PUHY-P200YKB-A1	PUHY-P250YKB-A1	PUHY-P250YKB-A1
	Fan air flow rate	m <sup>3</sup> /min	175	175	175	175	175
	External dimensions (HxLxW)	mm	1710 x 920 x 740	1710 x 920 x 740	1710 x 920 x 740	1710 x 920 x 740	1710 x 920 x 740
	Net weight	kg	190	190	190	199	199
	R410A refrigerant charge quantity	kg	6.5	6.5	6.5	8.0	8.0

## TECHNICAL SPECIFICATIONS

MODEL			PUHY-P550YSKB-A1(-BS)	PUHY-P600YSKB-A1(-BS)	PUHY-P650YSKB-A1(-BS)			
<b>HP</b>			22	24	26			
<b>Power</b>	Voltage/Freq./Phases	V/Hz/n°	3 phase 380-400-415V 50Hz	3 phase 380-400-415V 50Hz	3 phase 380-400-415V 50Hz			
<b>Cooling</b>	Nominal capacity <sup>1</sup>	kW	63.0	69.0	73.0			
	Power absorption	kW	16.66	19.43	20.97			
	EER		3.78	3.55	3.48			
	Operating temperature range	Indoor WB °C Outdoor DB °C	15.0~24.0 -5.0~52.0	15.0~24.0 -5.0~52.0	15.0~24.0 -5.0~52.0			
<b>Heating</b>	Nominal capacity <sup>2</sup>	kW	69.0	76.5	81.5			
	Power absorption	kW	17.29	19.36	21.0			
	COP		3.99	3.95	3.88			
	Operating temperature range	Indoor DB °C Outdoor WB °C	15.0~27.0 -20.0~15.5	15.0~27.0 -20.0~15.5	15.0~27.0 -20.0~15.5			
<b>Sound pressure<sup>3</sup></b>			63.5	63.5	64			
<b>Connectable indoor units</b>	Total capacity	50 to 130% of capacity of O.U.			50 to 130% of capacity of O.U.	50 to 130% of capacity of O.U.		
	Model/Quantity	P15~P250/2~47			P15~P250/2~50	P15~P250/2~50		
<b>External diameter of refrigerant connectors</b>	Liquid	mm	15.88	15.88	15.88			
	Gas	mm	28.58	28.58	28.58			
<b>Model</b>			PUHY-P250YKB-A1	PUHY-P300YKB-A1	PUHY-P250YKB-A1	PUHY-P350YKB-A1	PUHY-P300YKB-A1	PUHY-P350YKB-A1
	Fan air flow rate	m <sup>3</sup> /min	175	210	175	210	210	210
	External dimensions (HxLxW)	mm	1710 x 920 x 740	1710 x 1220 x 740	1710 x 920 x 740	1710 x 1220 x 740	1710 x 1220 x 740	1710 x 1220 x 740
	Net weight	kg	199	251	199	251	251	251
	R410A refrigerant charge quantity	kg	8.0	11.5	8.0	11.5	11.5	11.5

<sup>1</sup> Nominal cooling conditions: Indoor 27°C DB / 19°C WB, Outdoor 35°C DB. Piping length 7.5 m, vertical difference 0 m.

<sup>2</sup> Nominal heating conditions: Indoor 20°C DB. Outdoor 7°C DB / 6°C WB. Piping length 7.5 m, vertical difference 0 m.

<sup>3</sup> Values measured in anechoic chamber.

# Series Y Nominal double



PUHY-P YSKB-A1 OUTDOOR UNITS  
OPTIMISED FOR NOMINAL PERFORMANCE

E.T.C.

CONTINUOUS HEATING

## TECHNICAL SPECIFICATIONS



MODEL			PUHY-P700YSKB-A1(-BS)	PUHY-P750YSKB-A1(-BS)	PUHY-P800YSKB-A1(-BS)			
<b>HP</b>			28	30	32			
<b>Power</b>	Voltage/Freq./Phases	V/Hz/n°	3 phase 380-400-415V 50Hz					
<b>Cooling</b>	Nominal capacity <sup>1</sup>	kW	80.0	85.0	90.0			
	Power absorption	kW	24.69	26.56	27.86			
	EER		3.24	3.20	3.23			
	Operating temperature range	Indoor WB	°C	15.0~24.0				
Outdoor DB		°C	-5.0~52.0					
<b>Heating</b>	Nominal capacity <sup>2</sup>	kW	88.0	95.0	100.0			
	Power absorption	kW	22.97	24.93	27.62			
	COP		3.83	3.81	3.62			
	Operating temperature range	Indoor DB	°C	15.0~27.0				
		Outdoor WB	°C	-20.0~15.5				
<b>Sound pressure<sup>3</sup></b>			64	65.5	67.5			
<b>Connectable indoor units</b>	Total capacity		50 to 130% of capacity of O.U.					
	Model/Quantity		P15~P250/2~50					
<b>External diameter of refrigerant connectors</b>	Liquid	mm	19.05					
	Gas	mm	34.93					
<b>Model</b>			PUHY-P350YKB-A1	PUHY-P350YKB-A1	PUHY-P350YKB-A1	PUHY-P400YKB-A1	PUHY-P350YKB-A1	PUHY-P450YKB-A1
	Fan air flow rate	m³/min	210	210	210	210	210	360
	External dimensions (HxLxW)	mm	1710 x 1220 x 740	1710 x 1220 x 740	1710 x 1220 x 740	1710 x 1220 x 740	1710 x 1220 x 740	1710 x 1750 x 740
	Net weight	kg	251	251	251	251	251	304
	R410A refrigerant charge quantity	kg	11.5	11.5	11.5	11.5	11.5	11.8

## TECHNICAL SPECIFICATIONS



MODEL			PUHY-P850YSKB-A1(-BS)		PUHY-P900YSKB-A1(-BS)			
<b>HP</b>			34		36			
<b>Power</b>	Voltage/Freq./Phases	V/Hz/n°	3 phase 380-400-415V 50Hz					
<b>Cooling</b>	Nominal capacity <sup>1</sup>	kW	96.0		101.0			
	Power absorption	kW	30.18		31.46			
	EER		3.18		3.21			
	Operating temperature range	Indoor WB	°C	15.0~24.0		15.0~24.0		
Outdoor DB		°C	-5.0~52.0		-5.0~52.0			
<b>Heating</b>	Nominal capacity <sup>2</sup>	kW	108.0		113.0			
	Power absorption	kW	29.90		33.0			
	COP		3.61		3.42			
	Operating temperature range	Indoor DB	°C	15.0~27.0		15.0~27.0		
		Outdoor WB	°C	-20.0~15.5		-20.0~15.5		
<b>Sound pressure<sup>3</sup></b>			68		69			
<b>Connectable indoor units</b>	Total capacity		50 to 130% of capacity of O.U.					
	Model/Quantity		P15~P250/2~50					
<b>External diameter of refrigerant connectors</b>	Liquid	mm	19.05			19.05		
	Gas	mm	41.28			41.28		
<b>Model</b>			PUHY-P400YKB-A1	PUHY-P450YKB-A1	PUHY-P450YKB-A1	PUHY-P450YKB-A1		
	Fan air flow rate	m³/min	210	360	360	360		
	External dimensions (HxLxW)	mm	1710 x 1220 x 740	1710 x 1750 x 740	1710 x 1750 x 740	1710 x 1750 x 740		
	Net weight	kg	251	304	304	304		
	R410A refrigerant charge quantity	kg	11.5	11.8	11.8	11.8		

\*1 Nominal cooling conditions: Indoor 27°C DB / 19°C WB, Outdoor 35°C DB, Piping length 7.5 m, vertical difference 0 m.

\*2 Nominal heating conditions: Indoor 20°C DB, Outdoor 7°C DB / 6°C WB, Piping length 7.5 m, vertical difference 0 m.

\*3 Values measured in anechoic chamber.

# Series Y Nominal triple



PUHY-P YSKB-A1 OUTDOOR UNITS  
OPTIMISED FOR NOMINAL PERFORMANCE

E.T.C.

CONTINUOUS HEATING

OUTDOOR UNITS

## TECHNICAL SPECIFICATIONS

MODEL			PUHY-P950YSKB-A1(-BS)			PUHY-P1000YSKB-A1(-BS)				
<b>HP</b>			38			40				
<b>Power</b>			3 phase 380-400-415V 50Hz			3 phase 380-400-415V 50Hz				
<b>Cooling</b>	Voltage/Freq./Phases		V/Hz/n°							
	Nominal capacity <sup>1</sup>		kW		108.0			113.0		
	Power absorption		kW		30.25			32.10		
	EER				3.57			3.52		
<b>Heating</b>	Operating temperature range		Indoor WB °C		15.0~24.0			15.0~24.0		
			Outdoor DB °C		-5.0~52.0			-5.0~52.0		
	Nominal capacity <sup>2</sup>		kW		119.5			127.0		
	Power absorption		kW		30.40			32.70		
COP				3.93			3.88			
<b>Sound pressure<sup>3</sup></b>	Operating temperature range		Indoor DB °C		15.0~27.0			15.0~27.0		
			Outdoor WB °C		-20.0~15.5			-20.0~15.5		
<b>Connectable indoor units</b>			50 to 130% of capacity of O.U.			50 to 130% of capacity of O.U.				
Total capacity										
Model/Quantity			P15~P250/2~50			P15~P250/2~50				
<b>External diameter of refrigerant connectors</b>	Liquid		mm		19.05			19.05		
	Gas		mm		41.28			41.28		
<b>Model</b>			PUHY-P250YKB-A1	PUHY-P300YKB-A1	PUHY-P400YKB-A1	PUHY-P300YKB-A1	PUHY-P300YKB-A1	PUHY-P400YKB-A1		
Fan air flow rate			m <sup>3</sup> /min		175			210		
External dimensions (HxLxW)			mm		1710 x 920 x 740			1710 x 1220 x 740		
Net weight			kg		199			251		
R410A refrigerant charge quantity			kg		8.0			11.5		

## TECHNICAL SPECIFICATIONS

MODEL			PUHY-P1050YSKB-A1(-BS)			PUHY-P1100YSKB-A1(-BS)				
<b>HP</b>			42			44				
<b>Power</b>			3 phase 380-400-415V 50Hz			3 phase 380-400-415V 50Hz				
<b>Cooling</b>	Voltage/Freq./Phases		V/Hz/n°							
	Nominal capacity <sup>1</sup>		kW		118.0			124.0		
	Power absorption		kW		35.01			38.62		
	EER				3.37			3.21		
<b>Heating</b>	Operating temperature range		Indoor WB °C		15.0~24.0			15.0~24.0		
			Outdoor DB °C		-5.0~52.0			-5.0~52.0		
	Nominal capacity <sup>2</sup>		kW		132.0			140.0		
	Power absorption		kW		34.25			36.60		
COP				3.85			3.82			
<b>Sound pressure<sup>3</sup></b>	Operating temperature range		Indoor DB °C		15.0~27.0			15.0~27.0		
			Outdoor WB °C		-20.0~15.5			-20.0~15.5		
<b>Connectable indoor units</b>			50 to 130% of capacity of O.U.			50 to 130% of capacity of O.U.				
Total capacity										
Model/Quantity			P15~P250/2~50			P15~P250/2~50				
<b>External diameter of refrigerant connectors</b>	Liquid		mm		19.05			19.05		
	Gas		mm		41.28			41.28		
<b>Model</b>			PUHY-P300YKB-A1	PUHY-P350YKB-A1	PUHY-P400YKB-A1	PUHY-P350YKB-A1	PUHY-P350YKB-A1	PUHY-P400YKB-A1		
Fan air flow rate			m <sup>3</sup> /min		210			210		
External dimensions (HxLxW)			mm		1710 x 1220 x 740			1710 x 1220 x 740		
Net weight			kg		251			251		
R410A refrigerant charge quantity			kg		11.5			11.5		

<sup>1</sup> Nominal cooling conditions: Indoor 27°C DB / 19°C WB, Outdoor 35°C DB. Piping length 7.5 m, vertical difference 0 m.

<sup>2</sup> Nominal heating conditions: Indoor 20°C DB. Outdoor 7°C DB / 6°C WB. Piping length 7.5 m, vertical difference 0 m.

<sup>3</sup> Values measured in anechoic chamber.

# Series Y Nominal triple



PUHY-P YSKB-A1 OUTDOOR UNITS  
OPTIMISED FOR NOMINAL PERFORMANCE

E.T.C.

CONTINUOUS HEATING

## TECHNICAL SPECIFICATIONS



MODEL			PUHY-P1150YSKB-A1(-BS)			PUHY-P1200YSKB-A1(-BS)			
<b>HP</b>			46			48			
<b>Power</b>			3 phase 380-400-415V 50Hz			3 phase 380-400-415V 50Hz			
<b>Cooling</b>	Voltage/Freq./Phases		V/Hz/n°						
	Nominal capacity <sup>1</sup>		kW		130.0				
	Power absorption		kW		40.24				
	EER				3.23				
<b>Heating</b>	Operating temperature range		Indoor WB °C		15.0~24.0				
			Outdoor DB °C		-5.0~52.0				
	Nominal capacity <sup>2</sup>		kW		145.0				
	Power absorption		kW		39.29				
COP				3.69					
<b>Sound pressure<sup>3</sup></b>	Operating temperature range		Indoor DB °C		15.0~27.0				
			Outdoor WB °C		-20.0~15.5				
<b>Connectable indoor units</b>	Total capacity		50 to 130% of capacity of O.U.			50 to 130% of capacity of O.U.			
	Model/Quantity		P15~P250/2~50			P15~P250/2~50			
<b>External diameter of refrigerant connectors</b>	Liquid		mm		19.05				
	Gas		mm		41.28				
<b>Model</b>			PUHY-P350YKB-A1	PUHY-P350YKB-A1	PUHY-P450YKB-A1	PUHY-P350YKB-A1	PUHY-P400YKB-A1	PUHY-P450YKB-A1	
Fan air flow rate			m³/min		210			360	
External dimensions (HxLxW)			mm		1710 x 1220 x 740			1710 x 1750 x 740	
Net weight			kg		251			304	
R410A refrigerant charge quantity			kg		11.5			11.8	

## TECHNICAL SPECIFICATIONS



MODEL			PUHY-P1250YSKB-A1(-BS)			PUHY-P1300YSKB-A1(-BS)			
<b>HP</b>			50			52			
<b>Power</b>			3 phase 380-400-415V 50Hz			3 phase 380-400-415V 50Hz			
<b>Cooling</b>	Voltage/Freq./Phases		V/Hz/n°						
	Nominal capacity <sup>1</sup>		kW		140.0				
	Power absorption		kW		43.80				
	EER				3.19				
<b>Heating</b>	Operating temperature range		Indoor WB °C		15.0~24.0				
			Outdoor DB °C		-5.0~52.0				
	Nominal capacity <sup>2</sup>		kW		156.5				
	Power absorption		kW		44.08				
COP				3.55					
<b>Sound pressure<sup>3</sup></b>	Operating temperature range		Indoor DB °C		15.0~27.0				
			Outdoor WB °C		-20.0~15.5				
<b>Connectable indoor units</b>	Total capacity		50 to 130% of capacity of O.U.			50 to 130% of capacity of O.U.			
	Model/Quantity		P15~P250/2~50			P15~P250/2~50			
<b>External diameter of refrigerant connectors</b>	Liquid		mm		19.05				
	Gas		mm		41.28				
<b>Model</b>			PUHY-P350YKB-A1	PUHY-P450YKB-A1	PUHY-P450YKB-A1	PUHY-P400YKB-A1	PUHY-P450YKB-A1	PUHY-P450YKB-A1	
Fan air flow rate			m³/min		210			360	
External dimensions (HxLxW)			mm		1710 x 1220 x 740			1710 x 1750 x 740	
Net weight			kg		251			304	
R410A refrigerant charge quantity			kg		11.5			11.8	

\*1 Nominal cooling conditions: Indoor 27°C DB / 19°C WB, Outdoor 35°C DB, Piping length 7.5 m, vertical difference 0 m.

\*2 Nominal heating conditions: Indoor 20°C DB, Outdoor 7°C DB / 6°C WB, Piping length 7.5 m, vertical difference 0 m.

\*3 Values measured in anechoic chamber.



# Series Y Nominal triple



PUHY-P YSKB-A1 OUTDOOR UNITS  
OPTIMISED FOR NOMINAL PERFORMANCE

E.T.C. CONTINUOUS HEATING

OUTDOOR UNITS



## TECHNICAL SPECIFICATIONS

MODEL			PUHY-P1350YSKB-A1(-BS)		
HP			54		
Power			Voltage/Freq./Phases V/Hz/n° 3 phase 380-400-415V 50Hz		
Cooling	Nominal capacity <sup>1</sup>		kW 150.0		
	Power absorption		kW 47.40		
	EER		3.16		
	Operating temperature range	Indoor WB	°C	15.0~24.0	
Outdoor DB		°C	-5.0~52.0		
Heating	Nominal capacity <sup>2</sup>		kW 168.0		
	Power absorption		kW 49.12		
	COP		3.42		
	Operating temperature range	Indoor DB	°C	15.0~27.0	
Outdoor WB		°C	-20.0~15.5		
Sound pressure <sup>3</sup>			dB(A) 71		
Connectable indoor units	Total capacity		50 to 130% of capacity of O.U.		
	Model/Quantity		P15~P250/2~50		
External diameter of refrigerant connectors	Liquid		mm 19.05		
	Gas		mm 41.28		
Model			PUHY-P450YKB-A1	PUHY-P450YKB-A1	PUHY-P450YKB-A1
	Fan air flow rate		m³/min 360		
	External dimensions (HxLxW)		mm 1710 x 1750 x 740		
	Net weight		kg 304		
	R410A refrigerant charge quantity		kg 11.8		

# Series Y Nominal single

## LINE-UP EXTENSION



## TECHNICAL SPECIFICATIONS

MODEL			PUHY-P400YKB-A1	PUHY-P450YKB-A1	PUHY-P500YKB-A1
HP			16	18	20
Power			Voltage/Freq./Phases V/Hz/n° 3 phase 380-400-415V 50Hz		
Cooling	Nominal capacity <sup>1</sup>		kW 45 50 55		
	Power absorption		kW 13,55 14,79 18,39		
	EER		3,32 3,38 2,99		
	Operating temperature range	Indoor WB	°C	15.0~24.0	
Outdoor DB		°C	-5~52		
Heating	Nominal capacity <sup>2</sup>		kW 50 56 63		
	Power absorption		kW 12,50 15,55 18,52		
	COP		4 3,60 3,40		
	Operating temperature range	Indoor DB	°C	15.0~27.0	
Outdoor WB		°C	-20.0~15.5		
Sound pressure <sup>3</sup>			dB(A) 63 66 71		
Connectable indoor units	Total capacity		50 to 130% of capacity of O.U.		
	Model/Quantity		P15~P250 / 1~34 P15~P250 / 1~39 P15~P250 / 1~43		
External diameter of refrigerant connectors	Liquid		mm 12,7 15,88 15,88		
	Gas		mm 28,58 28,58 28,58		
Fan air flow rate			m³/min 210 360 360		
External dimensions (HxLxW)			mm 1710x1220x740* 1710x1750x740* 1710x1750x740*		
Net weight			kg 251 304 304		
R410A refrigerant charge quantity			kg 11,5 11,8 11,8		

\*<sup>1</sup> Nominal cooling conditions: Indoor 27°C DB / 19°C WB, Outdoor 35°C DB. Piping length 7.5 m, vertical difference 0 m.

\*<sup>2</sup> Nominal heating conditions: Indoor 20°C DB. Outdoor 7°C DB / 6°C WB. Piping length 7.5 m, vertical difference 0 m.

\*<sup>3</sup> Values measured in anechoic chamber.

# Series Y Seasonal single



PUHY-P YSKB-A1 OUTDOOR UNITS  
OPTIMISED FOR NOMINAL PERFORMANCE

E.T.C. CONTINUOUS HEATING FLAT TUBE



## TECHNICAL SPECIFICATIONS

MODEL			PUHY-EP200YLM-A1(-BS)	PUHY-EP250YLM-A1(-BS)	PUHY-EP300YLM-A1(-BS)	
HP			8	10	12	
Power	Voltage/Freq./Phases	V/Hz/n°	3 phase 380-400-415V 50Hz			
Cooling	Nominal capacity <sup>1</sup>	kW	22.4	28.0	33.5	
	Power absorption	kW	5.19	6.89	8.56	
	EER		4.31	4.06	3.91	
	SEER <sup>4</sup>		6.52	6.70	5.98	
	ESEER <sup>5</sup>		7.30	7.22	6.47	
	Operating temperature range	Indoor WB °C Outdoor DB °C		15.0~24.0 -5.0~52.0	15.0~24.0 -5.0~52.0	15.0~24.0 -5.0~52.0
Heating	Nominal capacity <sup>2</sup>	kW	25.0	31.5	37.5	
	Power absorption	kW	5.73	7.68	9.16	
	COP		4.36	4.10	4.09	
	SCOP <sup>4</sup>		3.90	3.66	3.47	
	Operating temperature range	Indoor DB °C Outdoor WB °C		15.0~27.0 -20.0~15.5	15.0~27.0 -20.0~15.5	15.0~27.0 -20.0~15.5
	Sound pressure <sup>3</sup>			57	60	61
Connectable indoor units	Total capacity	50 to 130% of capacity of O.U.				
	Model/Quantity		P15~P250 / 1~17	P15~P250 / 1~21	P15~P250 / 1~26	
External diameter of refrigerant connectors	Liquid	mm	9.52	9.52	9.52	
	Gas	mm	22.2	22.2	28.58	
	Fan air flow rate	m <sup>3</sup> /min	175	175	200	
	External dimensions (HxLxW)	mm	1710x920x740	1710x920x740	1710x1220x740	
	Net weight	kg	208	208	252	
	R410A refrigerant charge quantity	kg	7.5	7.5	10.3	



## TECHNICAL SPECIFICATIONS

MODEL			PUHY-EP350YLM-A1(-BS)	PUHY-EP400YLM-A1(-BS)	
HP			14	16	
Power	Voltage/Freq./Phases	V/Hz/n°	3 phase 380-400-415V 50Hz		
Cooling	Nominal capacity <sup>1</sup>	kW	40.0	45.0	
	Power absorption	kW	11.69	12.26	
	EER		3.42	3.67	
	SEER <sup>4</sup>		5.70	5.79	
	ESEER <sup>5</sup>		5.73	5.84	
	Operating temperature range	Indoor WB °C Outdoor DB °C		15.0~24.0 -5.0~52.0	15.0~24.0 -5.0~52.0
Heating	Nominal capacity <sup>2</sup>	kW	45.0	50.0	
	Power absorption	kW	12.53	13.15	
	COP		3.59	3.80	
	SCOP <sup>4</sup>		3.29	3.36	
	Operating temperature range	Indoor DB °C Outdoor WB °C		15.0~27.0 -20.0~15.5	15.0~27.0 -20.0~15.5
	Sound pressure <sup>3</sup>			61	62.5
Connectable indoor units	Total capacity	50 to 130% of capacity of O.U.			
	Model/Quantity		P15~P250 / 1~30	P15~P250 / 1~34	
External diameter of refrigerant connectors	Liquid	mm	12.7	12.7	
	Gas	mm	28.58	28.58	
	Fan air flow rate	m <sup>3</sup> /min	200	320	
	External dimensions (HxLxW)	mm	1710x1220x740	1710x1750x740	
	Net weight	kg	252	318	
	R410A refrigerant charge quantity	kg	10.3	11.8	

<sup>1</sup> Nominal cooling conditions: Indoor: 27°C DB / 19°C WB. Outdoor 35°C DB. Piping length 7.5 m, vertical difference 0 m.

<sup>2</sup> Nominal heating conditions: Indoor 20°C DB. Outdoor 7°C DB / 6°C WB. Piping length 7.5 m, vertical difference 0 m.

<sup>3</sup> Values measured in anechoic chamber.

<sup>4</sup> Values calculated according to EN14825 for AVERAGE (STRASBOURG) area.

<sup>5</sup> Value calculated according to EUROVENT formula.

# Series Y Seasonal single



PUHY-EP YLM-A1 OUTDOOR UNITS  
OPTIMIZED FOR SEASONAL PERFORMANCE

E.T.C.

CONTINUOUS HEATING

FLAT TUBE

OUTDOOR UNITS



## TECHNICAL SPECIFICATIONS

MODEL			PUHY-EP450YLM-A1(-BS)	PUHY-EP500YLM-A1(-BS)
<b>HP</b>			18	20
<b>Power</b>	Voltage/Freq./Phases	V/Hz/n°	3 phase 380-400-415V 50Hz	
<b>Cooling</b>	Nominal capacity <sup>1</sup>	kW	50.0	56.0
	Power absorption	kW	14.79	18.72
	EER		3.38	2.99
	SEER <sup>4</sup>		5.67	5.49
	ESEER <sup>5</sup>		5.71	5.46
Operating temperature range	Indoor WB	°C	15.0~24.0	15.0~24.0
	Outdoor DB	°C	-5.0~52.0	-5.0~52.0
<b>Heating</b>	Nominal capacity <sup>2</sup>	kW	56.0	63.0
	Power absorption	kW	16.09	19.68
	COP		3.48	3.20
	SCOP <sup>4</sup>		3.22	3.04
	Operating temperature range	Indoor DB	°C	15.0~27.0
Outdoor WB		°C	-20.0~15.5	-20.0~15.5
<b>Sound pressure<sup>3</sup></b>			63	63.5
<b>Connectable indoor units</b>	Total capacity		50 to 130% of capacity of O.U.	
	Model/Quantity		P15~P250 / 1~39	P15~P250 / 1~43
<b>External diameter of refrigerant connectors</b>	Liquid	mm	15.88	15.88
	Gas	mm	28.58	28.58
	Fan air flow rate	m <sup>3</sup> /min	370	370
	External dimensions (HxLxW)	mm	1710x1750x740	1710x1750x740
	Net weight	kg	318	332
	R410A refrigerant charge quantity	kg	11.8	11.8

<sup>1</sup> Nominal cooling conditions: Indoor: 27°C DB / 19°C WB, Outdoor 35°C DB. Piping length 7.5 m, vertical difference 0 m.

<sup>2</sup> Nominal heating conditions: Indoor 20°C DB. Outdoor 7°C DB / 6°C WB. Piping length 7.5 m, vertical difference 0 m.

<sup>3</sup> Values measured in anechoic chamber.

<sup>4</sup> Values calculated according to EN14825 for AVERAGE (STRASBOURG) area.

<sup>5</sup> Value calculated according to EUROVENT formula.

# Series Y Seasonal double



PUHY-EP YSLM-A1 OUTDOOR UNITS  
OPTIMIZED FOR SEASONAL PERFORMANCE

E.T.C.

CONTINUOUS HEATING

FLAT TUBE



## TECHNICAL SPECIFICATIONS

MODEL			PUHY-EP550YSLM-A1(-BS)		PUHY-EP600YSLM-A1(-BS)	
<b>HP</b>			22		24	
<b>Power</b>	Voltage/Freq./Phases	V/Hz/n°	3 phase 380-400-415V 50Hz			
<b>Cooling</b>	Nominal capacity <sup>1</sup>	kW	63.0		69.0	
	Power absorption	kW	16.62		18.59	
	EER		3.79		3.71	
	SEER <sup>4</sup>		6.17		5.82	
	ESEE <sup>5</sup>		5.99		5.85	
Operating temperature range	Indoor WB	°C	15.0~24.0		15.0~24.0	
	Outdoor DB	°C	-5.0~52.0		-5.0~52.0	
<b>Heating</b>	Nominal capacity <sup>2</sup>	kW	69.0		76.5	
	Power absorption	kW	17.73		19.66	
	COP		3.89		3.89	
	SCOP <sup>4</sup>		3.57		3.47	
	Operating temperature range	Indoor DB	°C	15.0~27.0		15.0~27.0
Outdoor WB		°C	-20.0~15.5		-20.0~15.5	
<b>Sound pressure<sup>3</sup></b>			63.5		64	
<b>Connectable indoor units</b>	Total capacity		50 to 130% of capacity of O.U.			
	Model/Quantity		P15~P250 / 2~47		P15~P250 / 2~50	
<b>External diameter of refrigerant connectors</b>	Liquid	mm	15.88		15.88	
	Gas	mm	28.58		28.58	
<b>Model</b>			<b>PUHY-EP250YLM-A1</b>	<b>PUHY-EP300YLM-A1</b>	<b>PUHY-EP300YLM-A1</b>	<b>PUHY-EP300YLM-A1</b>
	Fan air flow rate	m <sup>3</sup> /min	175	200	200	200
	External dimensions (HxLxW)	mm	1710x920x740	1710x1220x740	1710x1220x740	1710x1220x740
	Net weight	kg	208	252	252	252
	R410A refrigerant charge quantity	kg	7.5	10.3	10.3	10.3

<sup>1</sup> Nominal cooling conditions: Indoor: 27°C DB / 19°C WB. Outdoor 35°C DB. Piping length 7.5 m, vertical difference 0 m.

<sup>2</sup> Nominal heating conditions: Indoor 20°C DB. Outdoor 7°C DB / 6°C WB. Piping length 7.5 m, vertical difference 0 m.

<sup>3</sup> Values measured in anechoic chamber.

<sup>4</sup> Values calculated according to EN14825 for AVERAGE (STRASBOURG) area.

<sup>5</sup> Value calculated according to EUROVENT formula.

# Series Y Seasonal triple



PUHY-EP YSLM-A1 OUTDOOR UNITS  
OPTIMIZED FOR SEASONAL PERFORMANCE

E.T.C.

CONTINUOUS HEATING

FLAT TUBE

OUTDOOR UNITS

## TECHNICAL SPECIFICATIONS

MODEL			PUHY-EP650YSLM-A1(-BS)			PUHY-EP700YSLM-A1(-BS)		
<b>HP</b>			26			28		
<b>Power</b>			Voltage/Freq./Phases			V/Hz/n°		
			3 phase 380-400-415V 50Hz					
<b>Cooling</b>			Nominal capacity <sup>1</sup>			kW		
			Power absorption			kW		
			EER					
			SEER <sup>4</sup>					
			ESEE <sup>5</sup>					
Operating temperature range			Indoor WB °C			15.0~24.0		
			Outdoor DB °C			-5.0~52.0		
<b>Heating</b>			Nominal capacity <sup>2</sup>			kW		
			Power absorption			kW		
			COP					
			SCOP <sup>4</sup>					
			Operating temperature range			Indoor DB °C		
			Outdoor WB °C			-20.0~15.5		
<b>Sound pressure<sup>3</sup></b>			dB(A)			63		
<b>Connectable indoor units</b>			Total capacity			50 to 130% of capacity of O.U.		
			Model/Quantity			P15~P250 / 2~50		
<b>External diameter of refrigerant connectors</b>			Liquid			mm		
			Gas			mm		
<b>Model</b>			PUHY-EP200YLM-A1	PUHY-EP200YLM-A1	PUHY-EP250YLM-A1	PUHY-EP200YLM-A1	PUHY-EP200YLM-A1	PUHY-EP300YLM-A1
Fan air flow rate			m³/min			175		
External dimensions (HxLxW)			mm			1710x920x740		
Net weight			kg			208		
R410A refrigerant charge quantity			kg			7.5		

## TECHNICAL SPECIFICATIONS

MODEL			PUHY-EP750YSLM-A1(-BS)			PUHY-EP800YSLM-A1(-BS)		
<b>HP</b>			30			32		
<b>Power</b>			Voltage/Freq./Phases			V/Hz/n°		
			3 phase 380-400-415V 50Hz					
<b>Cooling</b>			Nominal capacity <sup>1</sup>			kW		
			Power absorption			kW		
			EER					
			SEER <sup>4</sup>					
			ESEE <sup>5</sup>					
Operating temperature range			Indoor WB °C			15.0~24.0		
			Outdoor DB °C			-5.0~52.0		
<b>Heating</b>			Nominal capacity <sup>2</sup>			kW		
			Power absorption			kW		
			COP					
			SCOP <sup>4</sup>					
			Operating temperature range			Indoor DB °C		
			Outdoor WB °C			-20.0~15.5		
<b>Sound pressure<sup>3</sup></b>			dB(A)			64.5		
<b>Connectable indoor units</b>			Total capacity			50 to 130% of capacity of O.U.		
			Model/Quantity			P15~P250 / 2~50		
<b>External diameter of refrigerant connectors</b>			Liquid			mm		
			Gas			mm		
<b>Model</b>			PUHY-EP200YLM-A1	PUHY-EP250YLM-A1	PUHY-EP300YLM-A1	PUHY-EP200YLM-A1	PUHY-EP300YLM-A1	PUHY-EP300YLM-A1
Fan air flow rate			m³/min			175		
External dimensions (HxLxW)			mm			1710x920x740		
Net weight			kg			208		
R410A refrigerant charge quantity			kg			7.5		

<sup>1</sup> Nominal cooling conditions: Indoor: 27°C DB / 19°C WB, Outdoor 35°C DB. Piping length 7.5 m, vertical difference 0 m.

<sup>2</sup> Nominal heating conditions: Indoor 20°C DB, Outdoor 7°C DB / 6°C WB. Piping length 7.5 m, vertical difference 0 m.

<sup>3</sup> Values measured in anechoic chamber.

<sup>4</sup> Values calculated according to EN14825 for AVERAGE (STRASBOURG) area.

<sup>5</sup> Value calculated according to EUROVENT formula.

# Series Y Seasonal triple



**PUHY-EP YSLM-A OUTDOOR UNITS  
OPTIMIZED FOR SEASONAL PERFORMANCE**

**E.T.C.**

**CONTINUOUS  
HEATING**

**FLAT TUBE**



## TECHNICAL SPECIFICATIONS

MODEL			PUHY-EP850YSLM-A1(-BS)			PUHY-EP900YSLM-A1(-BS)			
<b>HP</b>			34			36			
<b>Power</b>	Voltage/Freq./Phases	V/Hz/n°	3 phase 380-400-415V 50Hz						
<b>Cooling</b>	Nominal capacity <sup>1</sup>	kW	96.0			101.0			
	Power absorption	kW	25.53			27.22			
	EER		3.76			3.71			
	SEER <sup>4</sup>		6.05			5.82			
	ESEE <sup>5</sup>		5.97			5.89			
	Operating temperature range	Indoor WB °C		15.0~24.0			15.0~24.0		
	Outdoor DB °C		-5.0~52.0			-5.0~52.0			
<b>Heating</b>	Nominal capacity <sup>2</sup>	kW	108.0			113.0			
	Power absorption	kW	27.76			29.04			
	COP		3.89			3.89			
	SCOP <sup>4</sup>		3.53			3.47			
	Operating temperature range	Indoor DB °C		15.0~27.0			15.0~27.0		
		Outdoor WB °C		-20.0~15.5			-20.0~15.5		
<b>Sound pressure<sup>3</sup></b>		dB(A)	65.5						
<b>Connectable indoor units</b>	Total capacity		50 to 130% of capacity of O.U.						
	Model/Quantity		P15~P250 / 2~50			P15~P250 / 2~50			
<b>External diameter of refrigerant connectors</b>	Liquid	mm	19.05			19.05			
	Gas	mm	41.28			41.28			
<b>Model</b>			<b>PUHY-EP250YLM-A1</b>	<b>PUHY-EP300YLM-A1</b>	<b>PUHY-EP300YLM-A1</b>	<b>PUHY-EP300YLM-A1</b>	<b>PUHY-EP300YLM-A1</b>	<b>PUHY-EP300YLM-A1</b>	
	Fan air flow rate	m <sup>3</sup> /min	175	200	200	200	200	200	
	External dimensions (HxLxW)	mm	1710x920x740	1710x1220x740	1710x1220x740	1710x1220x740	1710x1220x740	1710x1220x740	
	Net weight	kg	208	252	252	252	252	252	
	R410A refrigerant charge quantity	kg	7.5	10.3	10.3	10.3	10.3	10.3	

<sup>1</sup> Nominal cooling conditions: Indoor: 27°C DB / 19°C WB. Outdoor 35°C DB. Piping length 7.5 m, vertical difference 0 m.

<sup>2</sup> Nominal heating conditions: Indoor 20°C DB. Outdoor 7°C DB / 6°C WB. Piping length 7.5 m, vertical difference 0 m.

<sup>3</sup> Values measured in anechoic chamber.

<sup>4</sup> Values calculated according to EN14825 for AVERAGE (STRASBOURG) area.

<sup>5</sup> Value calculated according to EUROVENT formula.

# Series Y Seasonal triple



PUHY-EP YSLM-A1 OUTDOOR UNITS  
OPTIMIZED FOR SEASONAL PERFORMANCE

E.T.C.

CONTINUOUS HEATING

FLAT TUBE

OUTDOOR UNITS

## TECHNICAL SPECIFICATIONS

MODEL			PUHY-EP950YSLM-A1(-BS)			PUHY-EP1000YSLM-A1(-BS)		
<b>HP</b>			38			40		
<b>Power</b>	Voltage/Freq./Phases	V/Hz/n°	3 phase 380-400-415V 50Hz			3 phase 380-400-415V 50Hz		
<b>Cooling</b>	Nominal capacity <sup>1</sup>	kW	108.0			113.0		
	Power absorption	kW	30.33			31.04		
	EER		3.56			3.64		
	SEER <sup>4</sup>		5.73			5.76		
	ESEE <sup>5</sup>		-			-		
Operating temperature range	Indoor WB	°C	15.0~24.0			15.0~24.0		
	Outdoor DB	°C	-5.0~52.0			-5.0~52.0		
<b>Heating</b>	Nominal capacity <sup>2</sup>	kW	119.5			127.0		
	Power absorption	kW	32.03			33.50		
	COP		3.73			3.79		
	SCOP <sup>4</sup>		3.41			3.43		
	Operating temperature range	Indoor DB	°C	15.0~27.0			15.0~27.0	
Outdoor WB		°C	-20.0~15.5			-20.0~15.5		
<b>Sound pressure<sup>3</sup></b>		dB(A)	66			66.5		
<b>Connectable indoor units</b>	Total capacity		50 to 130% of capacity of O.U.			50 to 130% of capacity of O.U.		
	Model/Quantity		P15~P250/2~50			P15~P250/2~50		
<b>External diameter of refrigerant connectors</b>	Liquid	mm	19.05			19.05		
	Gas	mm	41.28			41.28		
<b>Model</b>			PUHY-EP300YLM-A1	PUHY-EP300YLM-A1	PUHY-EP350YLM-A1	PUHY-EP300YLM-A1	PUHY-EP300YLM-A1	PUHY-EP400YLM-A1
	Fan air flow rate	m <sup>3</sup> /min	200	200	200	200	200	320
	External dimensions (HxLxW)	mm	1710x1220x740	1710x1220x740	1710x1220x740	1710x1220x740	1710x1220x740	1710x1750x740
	Net weight	kg	252	252	252	252	252	318
	R410A refrigerant charge quantity	kg	10.3	10.3	10.3	10.3	10.3	11.8

## TECHNICAL SPECIFICATIONS

MODEL			PUHY-EP1050YSLM-A1(-BS)			PUHY-EP1100YSLM-A1(-BS)		
<b>HP</b>			42			44		
<b>Power</b>	Voltage/Freq./Phases	V/Hz/n°	3 phase 380-400-415V 50Hz			3 phase 380-400-415V 50Hz		
<b>Cooling</b>	Nominal capacity <sup>1</sup>	kW	118.0			124.0		
	Power absorption	kW	34.40			38.15		
	EER		3.43			3.25		
	SEER <sup>4</sup>		5.67			5.58		
	ESEE <sup>5</sup>		-			-		
Operating temperature range	Indoor WB	°C	15.0~24.0			15.0~24.0		
	Outdoor DB	°C	-5.0~52.0			-5.0~52.0		
<b>Heating</b>	Nominal capacity <sup>2</sup>	kW	132.0			140.0		
	Power absorption	kW	36.87			41.17		
	COP		3.58			3.40		
	SCOP <sup>4</sup>		3.37			3.31		
	Operating temperature range	Indoor DB	°C	15.0~27.0			15.0~27.0	
Outdoor WB		°C	-20.0~15.5			-20.0~15.5		
<b>Sound pressure<sup>3</sup></b>		dB(A)	66.5			66.5		
<b>Connectable indoor units</b>	Total capacity		50 to 130% of capacity of O.U.			50 to 130% of capacity of O.U.		
	Model/Quantity		P15~P250/3~50			P15~P250/3~50		
<b>External diameter of refrigerant connectors</b>	Liquid	mm	19.05			19.05		
	Gas	mm	41.28			41.28		
<b>Model</b>			PUHY-EP300YLM-A1	PUHY-EP350YLM-A1	PUHY-EP400YLM-A1	PUHY-EP350YLM-A1	PUHY-EP350YLM-A1	PUHY-EP400YLM-A1
	Fan air flow rate	m <sup>3</sup> /min	200	200	320	200	200	320
	External dimensions (HxLxW)	mm	1710x1220x740	1710x1220x740	1710x1750x740	1710x1220x740	1710x1220x740	1710x1750x740
	Net weight	kg	252	252	318	252	252	318
	R410A refrigerant charge quantity	kg	10.3	10.3	11.8	10.3	10.3	11.8

<sup>1</sup> Nominal cooling conditions: Indoor: 27°C DB / 19°C WB, Outdoor 35°C DB, Piping length 7.5 m, vertical difference 0 m.

<sup>2</sup> Nominal heating conditions: Indoor 20°C DB, Outdoor 7°C DB / 6°C WB, Piping length 7.5 m, vertical difference 0 m.

<sup>3</sup> Values measured in anechoic chamber.

<sup>4</sup> Values calculated according to EN14825 for AVERAGE (STRASBOURG) area.

<sup>5</sup> Value calculated according to EUROVENT formula.

# Series Y Seasonal triple



**PUHY-EP YSLM-A1 OUTDOOR UNITS  
OPTIMIZED FOR SEASONAL PERFORMANCE**

**E.T.C.**

**CONTINUOUS  
HEATING**

**FLAT TUBE**



## TECHNICAL SPECIFICATIONS

MODEL			PUHY-EP1150YSLM-A1(-BS)			PUHY-EP1200YSLM-A1(-BS)		
<b>HP</b>			46			48		
<b>Power</b>	Voltage/Freq./Phases	V/Hz/n°	3 phase 380-400-415V 50Hz			3 phase 380-400-415V 50Hz		
<b>Cooling</b>	Nominal capacity <sup>1</sup>	kW	130.0			136.0		
	Power absorption	kW	41.53			42.76		
	EER		3.13			3.18		
	SEER <sup>4</sup>		5.54			5.57		
	ESEE <sup>5</sup>		-			-		
Operating temperature range	Indoor WB	°C	15.0~24.0			15.0~24.0		
	Outdoor DB	°C	-5.0~52.0			-5.0~52.0		
<b>Heating</b>	Nominal capacity <sup>2</sup>	kW	145.0			150.0		
	Power absorption	kW	44.47			45.45		
	COP		3.26			3.30		
	SCOP <sup>4</sup>		3.27			3.29		
	Operating temperature range	Indoor DB	°C	15.0~27.0			15.0~27.0	
Outdoor WB		°C	-20.0~15.5			-20.0~15.5		
<b>Sound pressure<sup>3</sup></b>			66.5			67		
<b>Connectable indoor units</b>	Total capacity	50 to 130% of capacity of O.U.						
	Model/Quantity	P15~P250/3~50						
<b>External diameter of refrigerant connectors</b>	Liquid	mm	19.05			19.05		
	Gas	mm	41.28			41.28		
<b>Model</b>			<b>PUHY-EP350YLM-A1</b>	<b>PUHY-EP350YLM-A1</b>	<b>PUHY-EP450YLM-A1</b>	<b>PUHY-EP350YLM-A1</b>	<b>PUHY-EP400YLM-A1</b>	<b>PUHY-EP450YLM-A1</b>
	Fan air flow rate	m <sup>3</sup> /min	200	200	370	200	320	370
	External dimensions (HxLxW)	mm	1710x1220x740	1710x1220x740	1710x1750x740	1710x1220x740	1710x1750x740	1710x1750x740
	Net weight	kg	252	252	318	252	318	318
	R410A refrigerant charge quantity	kg	10.3	10.3	11.8	10.3	11.8	11.8



## TECHNICAL SPECIFICATIONS

MODEL			PUHY-EP1250YSLM-A1(-BS)			PUHY-EP1300YSLM-A1(-BS)		
<b>HP</b>			50			52		
<b>Power</b>	Voltage/Freq./Phases	V/Hz/n°	3 phase 380-400-415V 50Hz			3 phase 380-400-415V 50Hz		
<b>Cooling</b>	Nominal capacity <sup>1</sup>	kW	140.0			146.0		
	Power absorption	kW	45.90			46.94		
	EER		3.05			3.11		
	SEER <sup>4</sup>		5.53			5.56		
	ESEE <sup>5</sup>		-			-		
Operating temperature range	Indoor WB	°C	15.0~24.0			15.0~24.0		
	Outdoor DB	°C	-5.0~52.0			-5.0~52.0		
<b>Heating</b>	Nominal capacity <sup>2</sup>	kW	156.5			163.0		
	Power absorption	kW	49.36			50.62		
	COP		3.17			3.22		
	SCOP <sup>4</sup>		3.24			3.27		
	Operating temperature range	Indoor DB	°C	15.0~27.0			15.0~27.0	
Outdoor WB		°C	-20.0~15.5			-20.0~15.5		
<b>Sound pressure<sup>3</sup></b>			67.5			68		
<b>Connectable indoor units</b>	Total capacity	50 to 130% of capacity of O.U.						
	Model/Quantity	P15~P250/3~50						
<b>External diameter of refrigerant connectors</b>	Liquid	mm	19.05			19.05		
	Gas	mm	41.28			41.28		
<b>Model</b>			<b>PUHY-EP350YLM-A1</b>	<b>PUHY-EP450YLM-A1</b>	<b>PUHY-EP450YLM-A1</b>	<b>PUHY-EP400YLM-A1</b>	<b>PUHY-EP450YLM-A1</b>	<b>PUHY-EP450YLM-A1</b>
	Fan air flow rate	m <sup>3</sup> /min	200	370	370	320	370	370
	External dimensions (HxLxW)	mm	1710x1220x740	1710x1750x740	1710x1750x740	1710x1750x740	1710x1750x740	1710x1750x740
	Net weight	kg	252	318	318	318	318	318
	R410A refrigerant charge quantity	kg	10.3	11.8	11.8	11.8	11.8	11.8

<sup>1</sup> Nominal cooling conditions: Indoor: 27°C DB / 19°C WB. Outdoor 35°C DB. Piping length 7.5 m, vertical difference 0 m.

<sup>2</sup> Nominal heating conditions: Indoor 20°C DB. Outdoor 7°C DB / 6°C WB. Piping length 7.5 m, vertical difference 0 m.

<sup>3</sup> Values measured in anechoic chamber.

<sup>4</sup> Values calculated according to EN14825 for AVERAGE (STRASBOURG) area.

<sup>5</sup> Value calculated according to EUROVENT formula.



# Series Y Seasonal triple



PUHY-EP YSLM-A1 OUTDOOR UNITS  
OPTIMIZED FOR SEASONAL PERFORMANCE

E.T.C.

CONTINUOUS HEATING

FLAT TUBE

OUTDOOR UNITS



## TECHNICAL SPECIFICATIONS

MODEL		PUHY-EP1350YSLM-A1(-BS)		
HP		54		
Power	Voltage/Freq./Phases	V/Hz/n°	3 phase 380-400-415V 50Hz	
Cooling	Nominal capacity <sup>1</sup>	kW	150	
	Power absorption	kW	50.0	
	EER		3.00	
	SEER <sup>4</sup>		5,52	
	ESEE <sup>5</sup>		-	
Operating temperature range	Indoor WB	°C	15.0~24.0	
	Outdoor DB	°C	-5.0~52.0	
Heating	Nominal capacity <sup>2</sup>	kW	168.0	
	Power absorption	kW	54.36	
	COP		3.09	
	SCOP <sup>4</sup>		3,22	
	Operating temperature range	Indoor DB	°C	15.0~27.0
Outdoor WB		°C	-20.0~15.5	
Sound pressure <sup>3</sup>		dB(A)		68
Connectable indoor units	Total capacity	50 to 130% of capacity of O.U.		
	Model/Quantity	P15~P250/3~50		
External diameter of refrigerant connectors	Liquid	mm	19.05	
	Gas	mm	41.28	
Model		PUHY-EP450YLM-A1	PUHY-EP450YLM-A1	PUHY-EP450YLM-A1
Fan air flow rate		m <sup>3</sup> /min	370	370
External dimensions (HxLxW)		mm	1710x1750x740	1710x1750x740
Net weight		kg	318	318
R410A refrigerant charge quantity		kg	11.8	11.8

<sup>1</sup> Nominal cooling conditions: Indoor: 27°C DB / 19°C WB. Outdoor 35°C DB. Piping length 7.5 m, vertical difference 0 m.

<sup>2</sup> Nominal heating conditions: Indoor 20°C DB. Outdoor 7°C DB / 6°C WB. Piping length 7.5 m, vertical difference 0 m.

<sup>3</sup> Values measured in anechoic chamber.

<sup>4</sup> Values calculated according to EN14825 for AVERAGE (STRASBOURG) area.

<sup>5</sup> Value calculated according to EUROVENT formula.

# Series R2 Nominal single



PURY-P YLM-A1 OUTDOOR UNITS  
OPTIMISED FOR NOMINAL PERFORMANCE

E.T.C. CONTINUOUS HEATING

## TECHNICAL SPECIFICATIONS



MODEL			PURY-P200YLM-A1(-BS)	PURY-P250YLM-A1(-BS)
<b>HP</b>			8	10
<b>Power</b>	Voltage/Freq./Phases	V/Hz/n°	3 phase 380-400-415V 50Hz	3 phase 380-400-415V 50Hz
<b>Cooling</b>	Nominal capacity <sup>1</sup>	kW	22.4	28.0
	Power absorption	kW	5.29	6.98
	EER		4.23	4.01
	Operating temperature range	Indoor WB °C Outdoor DB °C	15.0~24.0 -5.0~46.0	15.0~24.0 -5.0~46.0
<b>Heating</b>	Nominal capacity <sup>2</sup>	kW	25.0	31.5
	Power absorption	kW	5.49	7.32
	COP		4.55	4.30
	Operating temperature range	Indoor DB °C Outdoor WB °C	15.0~27.0 -20.0~15.5	15.0~27.0 -20.0~15.5
<b>Sound pressure<sup>3</sup></b>			59	60
<b>Connectable indoor units</b>	Total capacity		50 to 150% of capacity of O.U.	50 to 150% of capacity of O.U.
	Model/Quantity		P15~P250/1~20	P15~P250/1~25
<b>External diameter of refrigerant connectors</b>	Liquid	mm	15.88	19.05
	Gas	mm	19.05	22.2
	Fan air flow rate	m <sup>3</sup> /min	185	185
	External dimensions (HxLxW)	mm	1710x920x740	1710x920x740
	Net weight	kg	205	205
	R410A refrigerant charge quantity	kg	9.5	9.5

## TECHNICAL SPECIFICATIONS



MODEL			PURY-P300YLM-A1(-BS)	PURY-P350YLM-A1(-BS)
<b>HP</b>			12	14
<b>Power</b>	Voltage/Freq./Phases	V/Hz/n°	3 phase 380-400-415V 50Hz	3 phase 380-400-415V 50Hz
<b>Cooling</b>	Nominal capacity <sup>1</sup>	kW	33.5	40.0
	Power absorption	kW	9.10	11.76
	EER		3.68	3.40
	Operating temperature range	Indoor WB °C Outdoor DB °C	15.0~24.0 -5.0~46.0	15.0~24.0 -5.0~46.0
<b>Heating</b>	Nominal capacity <sup>2</sup>	kW	37.5	45.0
	Power absorption	kW	9.37	11.59
	COP		4.00	3.88
	Operating temperature range	Indoor DB °C Outdoor WB °C	15.0~27.0 -20.0~15.5	15.0~27.0 -20.0~15.5
<b>Sound pressure<sup>3</sup></b>			62.5	62.5
<b>Connectable indoor units</b>	Total capacity		50 to 150% of capacity of O.U.	50 to 150% of capacity of O.U.
	Model/Quantity		P15~P250/1~30	P15~P250/1~35
<b>External diameter of refrigerant connectors</b>	High pressure	mm	19.05	19.05
	Low pressure	mm	22.2	28.58
	Fan air flow rate	m <sup>3</sup> /min	230	230
	External dimensions (HxLxW)	mm	1710 x 1220 x 740	1710 x 1220 x 740
	Net weight	kg	248	248
	R410A refrigerant charge quantity	kg	10.3	10.3

\*1 Nominal cooling conditions: Indoor 27°C DB / 19°C WB, Outdoor 35°C DB, Piping length 7.5 m, vertical difference 0 m.

\*2 Nominal heating conditions: Indoor 20°C DB, Outdoor 7°C DB / 6°C WB, Piping length 7.5 m, vertical difference 0 m.

\*3 Values measured in anechoic chamber.

# Series R2 Nominal double



PURY-P YSLM-A1 OUTDOOR UNITS  
OPTIMISED FOR NOMINAL PERFORMANCE

E.T.C.

CONTINUOUS HEATING

OUTDOOR UNITS

## TECHNICAL SPECIFICATIONS

MODEL			PURY-P400YSLM-A1(-BS)		PURY-P450YSLM-A1(-BS)	
<b>HP</b>			16		18	
<b>Power</b>			3 phase 380-400-415V 50Hz		3 phase 380-400-415V 50Hz	
<b>Cooling</b>	Voltage/Freq./Phases		V/Hz/n°		3 phase 380-400-415V 50Hz	
	Nominal capacity <sup>1</sup>		kW		45.0	
	Power absorption		kW		10.97	
	EER				4.10	
<b>Heating</b>	Operating temperature range	Indoor WB	°C	15.0~24.0	15.0~24.0	
		Outdoor DB	°C	-5.0~46.0	-5.0~46.0	
	Nominal capacity <sup>2</sup>		kW		50.0	
	Power absorption		kW		10.98	
COP				4.55		
Operating temperature range	Indoor DB	°C	15.0~27.0	15.0~27.0		
	Outdoor WB	°C	-20.0~15.5	-20.0~15.5		
<b>Sound pressure<sup>3</sup></b>			dB(A)		62	
<b>Connectable indoor units</b>	Total capacity		50 to 150% of capacity of O.U.		50 to 150% of capacity of O.U.	
	Model/Quantity		P15~P250/1~40		P15~P250/1~45	
<b>External diameter of refrigerant connectors</b>	Liquid		mm		22.2	
	Gas		mm		28.58	
<b>Model</b>			PURY-P200YLM-A1	PURY-P200YLM-A1	PURY-P200YLM-A1	PURY-P250YLM-A1
Fan air flow rate			m <sup>3</sup> /min	185	185	185
External dimensions (HxLxW)			mm	1710x920x740	1710x920x740	1710x920x740
Net weight			kg	205	205	205
R410A refrigerant charge quantity			kg	9.5	9.5	9.5

## TECHNICAL SPECIFICATIONS

MODEL			PURY-P500YSLM-A1(-BS)		PURY-P550YSLM-A1(-BS)	
<b>HP</b>			20		22	
<b>Power</b>			3 phase 380-400-415V 50Hz		3 phase 380-400-415V 50Hz	
<b>Cooling</b>	Voltage/Freq./Phases		V/Hz/n°		3 phase 380-400-415V 50Hz	
	Nominal capacity <sup>1</sup>		kW		56.0	
	Power absorption		kW		14.39	
	EER				3.89	
<b>Heating</b>	Operating temperature range	Indoor WB	°C	15.0~24.0	15.0~24.0	
		Outdoor DB	°C	-5.0~46.0	-5.0~46.0	
	Nominal capacity <sup>2</sup>		kW		63.0	
	Power absorption		kW		14.65	
COP				4.30		
Operating temperature range	Indoor DB	°C	15.0~27.0	15.0~27.0		
	Outdoor WB	°C	-20.0~15.5	-20.0~15.5		
<b>Sound pressure<sup>3</sup></b>			dB(A)		63	
<b>Connectable indoor units</b>	Total capacity		50 to 150% of capacity of O.U.		50 to 150% of capacity of O.U.	
	Model/Quantity		P15~P250/1~50		P15~P250/2~50	
<b>External diameter of refrigerant connectors</b>	Liquid		mm		22.2	
	Gas		mm		28.58	
<b>Model</b>			PURY-P250YLM-A1	PURY-P250YLM-A1	PURY-P250YLM-A1	PURY-P300YLM-A1
Fan air flow rate			m <sup>3</sup> /min	185	185	230
External dimensions (HxLxW)			mm	1710x920x740	1710x920x740	1710x1220x740
Net weight			kg	205	205	248
R410A refrigerant charge quantity			kg	9.5	9.5	10.3

<sup>1</sup> Nominal cooling conditions: Indoor 27°C DB / 19°C WB, Outdoor 35°C DB. Piping length 7.5 m, vertical difference 0 m.

<sup>2</sup> Nominal heating conditions: Indoor 20°C DB. Outdoor 7°C DB / 6°C WB. Piping length 7.5 m, vertical difference 0 m.

<sup>3</sup> Values measured in anechoic chamber.

# Series R2 Nominal double



PURY-P YSLM-A1 OUTDOOR UNITS  
OPTIMISED FOR NOMINAL PERFORMANCE

E.T.C. CONTINUOUS HEATING



## TECHNICAL SPECIFICATIONS

MODEL			PURY-P600YSLM-A1(-BS)		PURY-P650YSLM-A1(-BS)	
<b>HP</b>			24		26	
<b>Power</b>			3 phase 380-400-415V 50Hz		3 phase 380-400-415V 50Hz	
<b>Cooling</b>	Voltage/Freq./Phases		V/Hz/n°		3 phase 380-400-415V 50Hz	
	Nominal capacity <sup>1</sup>		kW		69.0	
	Power absorption		kW		19.32	
	EER				3.57	
<b>Heating</b>	Operating temperature range		Indoor WB °C		15.0~24.0	
			Outdoor DB °C		-5.0~46.0	
	Nominal capacity <sup>2</sup>		kW		76.5	
	Power absorption		kW		19.12	
COP			4.00		3.94	
<b>Sound pressure<sup>3</sup></b>	Operating temperature range		Indoor DB °C		15.0~27.0	
			Outdoor WB °C		-20.0~15.5	
Connectable indoor units			50 to 150% of capacity of O.U.		50 to 150% of capacity of O.U.	
External diameter of refrigerant connectors			28.58		28.58	
Model			PURY-P300YLM-A1		PURY-P350YLM-A1	
Fan air flow rate			m <sup>3</sup> /min		230	
External dimensions (HxLxW)			mm		1710x1220x740	
Net weight			kg		248	
R410A refrigerant charge quantity			kg		10.3	



## TECHNICAL SPECIFICATIONS

MODEL			PURY-P700YSLM-A1(-BS)		PURY-P750YSLM-A1(-BS)	
<b>HP</b>			28		30	
<b>Power</b>			3 phase 380-400-415V 50Hz		3 phase 380-400-415V 50Hz	
<b>Cooling</b>	Voltage/Freq./Phases		V/Hz/n°		3 phase 380-400-415V 50Hz	
	Nominal capacity <sup>1</sup>		kW		80.0	
	Power absorption		kW		24.24	
	EER				3.30	
<b>Heating</b>	Operating temperature range		Indoor WB °C		15.0~24.0	
			Outdoor DB °C		-5.0~46.0	
	Nominal capacity <sup>2</sup>		kW		88.0	
	Power absorption		kW		22.68	
COP			3.88		3.91	
<b>Sound pressure<sup>3</sup></b>	Operating temperature range		Indoor DB °C		15.0~27.0	
			Outdoor WB °C		-20.0~15.5	
Connectable indoor units			50 to 150% of capacity of O.U.		50 to 150% of capacity of O.U.	
External diameter of refrigerant connectors			28.58		28.58	
Model			PURY-P350YLM-A1		PURY-P400YLM-A1	
Fan air flow rate			m <sup>3</sup> /min		230	
External dimensions (HxLxW)			mm		1710x1220x740	
Net weight			kg		248	
R410A refrigerant charge quantity			kg		10.3	

\*1 Nominal cooling conditions: Indoor 27°C DB / 19°C WB, Outdoor 35°C DB, Piping length 7.5 m, vertical difference 0 m.

\*2 Nominal heating conditions: Indoor 20°C DB, Outdoor 7°C DB / 6°C WB, Piping length 7.5 m, vertical difference 0 m.

\*3 Values measured in anechoic chamber.

# Series R2 Nominal double



PURY-P YSLM-A1 OUTDOOR UNITS  
OPTIMISED FOR NOMINAL PERFORMANCE

E.T.C.

CONTINUOUS HEATING

OUTDOOR UNITS

## TECHNICAL SPECIFICATIONS

MODEL			PURY-P800YSLM-A1(-BS)		PURY-P850YSLM-A1(-BS)	
HP			32		34	
Power			Voltage/Freq./Phases		V/Hz/n°	
Cooling			3 phase 380-400-415V 50Hz		3 phase 380-400-415V 50Hz	
			Nominal capacity <sup>1</sup>		kW	
			90.0		96.0	
			Power absorption		kW	
			28.30		29.26	
			EER		3.18	
			3.28			
			Operating temperature range		Indoor WB °C	
			15.0~24.0		15.0~24.0	
			Outdoor DB °C		-5.0~46.0	
			-5.0~46.0			
Heating			Nominal capacity <sup>2</sup>		kW	
			90.0		101.0	
			Power absorption		kW	
			22.84		26.23	
			COP		3.94	
			3.85			
			Operating temperature range		Indoor DB °C	
			15.0~27.0		15.0~27.0	
			Outdoor WB °C		-20.0~-15.5	
			-20.0~-15.5			
Sound pressure <sup>3</sup>			dB(A)		65.5	
Connectable indoor units			Total capacity		50 to 150% of capacity of O.U.	
			Model/Quantity		P15~P250/2~50	
External diameter of refrigerant connectors			Liquid		mm	
			28.58		28.58	
			Gas		mm	
			34.93		41.28	
Model			PURY-P400YLM-A1		PURY-P450YLM-A1	
			Fan air flow rate		m³/min	
			230		320	
			External dimensions (HxLxW)		mm	
			1710x1220x740		1710x1220x740	
			Net weight		kg	
			246		321	
			R410A refrigerant charge quantity		kg	
			10.3		11.8	

## TECHNICAL SPECIFICATIONS

MODEL			PURY-P900YSLM-A1(-BS)	
HP			36	
Power			Voltage/Freq./Phases	
Cooling			3 phase 380-400-415V 50Hz	
			Nominal capacity <sup>1</sup>	
			kW	
			101.0	
			Power absorption	
			kW	
			29.79	
			EER	
			3.39	
			Operating temperature range	
			Indoor WB °C	
			15.0~24.0	
			Outdoor DB °C	
			-5.0~46.0	
Heating			Nominal capacity <sup>2</sup>	
			kW	
			113.0	
			Power absorption	
			kW	
			30.13	
			COP	
			3.75	
			Operating temperature range	
			Indoor DB °C	
			15.0~27.0	
			Outdoor WB °C	
			-20.0~-15.5	
Sound pressure <sup>3</sup>			dB(A)	
			65.5	
Connectable indoor units			Total capacity	
			50 to 150% of capacity of O.U.	
			Model/Quantity	
			P15~P250/2~50	
External diameter of refrigerant connectors			Liquid	
			mm	
			28.58	
			Gas	
			mm	
			41.28	
Model			PURY-P450YLM-A1	
			Fan air flow rate	
			m³/min	
			320	
			External dimensions (HxLxW)	
			mm	
			1710x1750x740	
			Net weight	
			kg	
			321	
			R410A refrigerant charge quantity	
			kg	
			11.8	

\*1 Nominal cooling conditions: Indoor 27°C DB / 19°C WB, Outdoor 35°C DB. Piping length 7.5 m, vertical difference 0 m.

\*2 Nominal heating conditions: Indoor 20°C DB. Outdoor 7°C DB / 6°C WB. Piping length 7.5 m, vertical difference 0 m.

\*3 Values measured in anechoic chamber.

# Series R2 Seasonal single



PURY-EP YLM-A1 OUTDOOR UNITS  
OPTIMIZED FOR SEASONAL PERFORMANCE

E.T.C.

CONTINUOUS HEATING

FLAT TUBE



## TECHNICAL SPECIFICATIONS

MODEL			PURY-EP200YLM-A1(-BS)	PURY-EP250YLM-A1(-BS)	PURY-EP300YLM-A1(-BS)
<b>HP</b>			8	10	12
<b>Power</b>	Voltage/Freq./Phases	V/Hz/n°	3 phase 380-400-415V 50Hz		
<b>Cooling</b>	Nominal capacity <sup>1</sup>	kW	22.4	28.0	33.5
	Power absorption	kW	5.48	7.25	9.20
	EER		4.08	3.86	3.64
	SEER <sup>4</sup>		6.52	6.24	5.66
	ESEER <sup>5</sup>		7.16	7.06	5.52
	Operating temperature range	Indoor WB °C	15.0~24.0°C	15.0~24.0°C	15.0~24.0°C
	Outdoor DB °C	-5.0~46.0°C	-5.0~46.0°C	-5.0~46.0°C	
<b>Heating</b>	Nominal capacity <sup>2</sup>	kW	25.0	31.5	37.5
	Power absorption	kW	6.41	8.45	9.97
	COP		3.90	3.72	3.76
	SCOP <sup>4</sup>		3.91	3.60	3.52
	Operating temperature range	Indoor DB °C	15.0~27.0°C	15.0~27.0°C	15.0~27.0°C
		Outdoor WB °C	-20.0~15.5°C	-20.0~15.5°C	-20.0~15.5°C
<b>Sound pressure<sup>3</sup></b>			59	60	62.5
<b>Connectable indoor units</b>	Total capacity		50 to 150% of capacity of O.U.	50 to 150% of capacity of O.U.	50 to 150% of capacity of O.U.
	Model/Quantity		P15~P250/1~20	P15~P250/1~25	P15~P250/1~30
<b>External diameter of refrigerant connectors</b>	Liquid	mm	15.88	19.05	19.05
	Gas	mm	19.05	22.2	22.2
	Fan air flow rate	m <sup>3</sup> /min	185	185	230
	External dimensions (HxLxW)	mm	1710x920x740	1710x920x740	1710x1220x740
	Net weight	kg	218	218	260
	R410A refrigerant charge quantity	kg	8.5	8.5	9.3



## TECHNICAL SPECIFICATIONS

MODEL			PURY-EP350YLM-A1(-BS)	PURY-EP400YLM-A1(-BS)
<b>HP</b>			14	16
<b>Power</b>	Voltage/Freq./Phases	V/Hz/n°	3 phase 380-400-415V 50Hz	
<b>Cooling</b>	Nominal capacity <sup>1</sup>	kW	40.0	45.0
	Power absorption	kW	12.57	12.56
	EER		3.18	3.58
	SEER <sup>4</sup>		5.47	5.41
	ESEER <sup>5</sup>		5.22	5.54
	Operating temperature range	Indoor DB °C	15.0~24.0°C	15.0~24.0°C
	Outdoor WB °C	-5.0~46.0°C	-5.0~46.0°C	
<b>Heating</b>	Nominal capacity <sup>2</sup>	kW	45	50.0
	Power absorption	kW	12.93	13.40
	COP		3.48	3.73
	SCOP <sup>4</sup>		3.25	3.40
	Operating temperature range	Indoor WB °C	15.0~27.0°C	15.0~27.0°C
		Outdoor DB °C	-20.0~15.5°C	-20.0~15.5°C
<b>Sound pressure<sup>3</sup></b>			62.5	62.5
<b>Connectable indoor units</b>	Total capacity		50 to 150% of capacity of O.U.	50 to 150% of capacity of O.U.
	Model/Quantity		P15~P250/1~35	P15~P250/1~40
<b>External diameter of refrigerant connectors</b>	Liquid	mm	19.05	22.2
	Gas	mm	28.58	28.58
	Fan air flow rate	m <sup>3</sup> /min	230	320
	External dimensions (HxLxW)	mm	1710x1220x740	1710x1750x740
	Net weight	kg	260	338
	R410A refrigerant charge quantity	kg	9.3	11.8

<sup>1</sup> Nominal cooling conditions: Indoor: 27°C DB / 19°C WB, Outdoor 35°C DB, Piping length 7.5 m, vertical difference 0 m.

<sup>2</sup> Nominal heating conditions: Indoor 20°C DB, Outdoor 7°C DB / 6°C WB, Piping length 7.5 m, vertical difference 0 m.

<sup>3</sup> Values measured in anechoic chamber.

<sup>4</sup> Values calculated according to EN14825 for AVERAGE (STRASBOURG) area.

<sup>5</sup> Value calculated according to EUROVENT formula.

# Series R2 Seasonal single



PURY-EP YLM-A1 OUTDOOR UNITS  
OPTIMIZED FOR SEASONAL PERFORMANCE

E.T.C.

CONTINUOUS HEATING

FLAT TUBE

OUTDOOR UNITS



## TECHNICAL SPECIFICATIONS

MODEL			PURY-EP450YLM-A1(-BS)	PURY-EP500YLM-A1(-BS)
<b>HP</b>			18	20
<b>Power</b>	Voltage/Freq./Phases	V/Hz/n°	3 phase 380-400-415V 50Hz	
<b>Cooling</b>	Nominal capacity <sup>1</sup>	kW	50.0	56.0
	Power absorption	kW	14.83	18.30
	EER		3.37	3.06
	SEER <sup>4</sup>		5.26	5.19
	ESEER <sup>5</sup>		5.27	5.34
Operating temperature range	Indoor WB	°C	15.0~24.0°C	15.0~24.0°C
	Outdoor DB	°C	-5.0~46.0°C	-5.0~46.0°C
<b>Heating</b>	Nominal capacity <sup>2</sup>	kW	56.0	63.0
	Power absorption	kW	15.86	19.54
	COP		3.53	3.22
	SCOP <sup>4</sup>		3.18	3.04
	Operating temperature range	Indoor DB	°C	15.0~27.0°C
Outdoor WB		°C	-20.0~15.5°C	-20.0~15.5°C
<b>Sound pressure<sup>3</sup></b>		dB(A)	62.5	63.5
<b>Connectable indoor units</b>	Total capacity		50 to 150% of capacity of O.U.	50 to 150% of capacity of O.U.
	Model/Quantity		P15~P250/1~45	P15~P250/1~50
<b>External diameter of refrigerant connectors</b>	Liquid	mm	22.2	22.2
	Gas	mm	28.58	28.58
	Fan air flow rate	m <sup>3</sup> /min	320	380
	External dimensions (HxLxW)	mm	1710x1750x740	1710x1750x740
	Net weight	kg	338	351
	R410A refrigerant charge quantity	kg	11.8	11.8

<sup>1</sup> Nominal cooling conditions: Indoor: 27°C DB / 19°C WB, Outdoor 35°C DB. Piping length 7.5 m, vertical difference 0 m.

<sup>2</sup> Nominal heating conditions: Indoor 20°C DB. Outdoor 7°C DB / 6°C WB. Piping length 7.5 m, vertical difference 0 m.

<sup>3</sup> Values measured in anechoic chamber.

<sup>4</sup> Values calculated according to EN14825 for AVERAGE (STRASBOURG) area.

<sup>5</sup> Value calculated according to EUROVENT formula.

# Series R2 Seasonal double



PURY-EP YSLM-A1 OUTDOOR UNITS  
OPTIMIZED FOR SEASONAL PERFORMANCE

E.T.C.

CONTINUOUS HEATING

FLAT TUBE



## TECHNICAL SPECIFICATIONS

MODEL			PURY-EP550YSLM-A1(-BS)		PURY-EP600YSLM-A1(-BS)	
<b>HP</b>			22		24	
<b>Power</b>			3 phase 380-400-415V 50Hz		3 phase 380-400-415V 50Hz	
<b>Cooling</b>	Voltage/Freq./Phases		V/Hz/n°			
	Nominal capacity <sup>1</sup>		kW		63.0	
	Power absorption		kW		17.35	
	EER				3.63	
	SEER <sup>4</sup>				5.79	
	ESEER <sup>5</sup>				5.58	
<b>Heating</b>	Operating temperature range		Indoor WB °C		15.0~24.0°C	
			Outdoor DB °C		-5.0~46.0°C	
	Nominal capacity <sup>2</sup>		kW		69.0	
	Power absorption		kW		18.44	
	COP				3.74	
	SCOP <sup>4</sup>				3.56	
<b>Sound pressure<sup>3</sup></b>	Operating temperature range		Indoor DB °C		15.0~27.0°C	
			Outdoor WB °C		-20.0~15.5°C	
<b>Connectable indoor units</b>			50 to 150% of capacity of O.U.		50 to 150% of capacity of O.U.	
Total capacity						
Model/Quantity			P15~P250/2~50		P15~P250/2~50	
<b>External diameter of refrigerant connectors</b>	Liquid		mm		28.58	
	Gas		mm		28.58	
<b>Model</b>			PURY-EP250YLM-A1		PURY-EP300YLM-A1	
Fan air flow rate			m <sup>3</sup> /min		230	
External dimensions (HxLxW)			mm		1710x1220x740	
Net weight			kg		260	
R410A refrigerant charge quantity			kg		9.3	



## TECHNICAL SPECIFICATIONS

MODEL			PURY-EP650YSLM-A1(-BS)		PURY-EP700YSLM-A1(-BS)	
<b>HP</b>			26		28	
<b>Power</b>			3 phase 380-400-415V 50Hz		3 phase 380-400-415V 50Hz	
<b>Cooling</b>	Voltage/Freq./Phases		V/Hz/n°			
	Nominal capacity <sup>1</sup>		kW		73.0	
	Power absorption		kW		22.12	
	EER				3.30	
	SEER <sup>4</sup>				5.41	
	ESEER <sup>5</sup>				4.92	
<b>Heating</b>	Operating temperature range		Indoor WB °C		15.0~24.0°C	
			Outdoor DB °C		-5.0~46.0°C	
	Nominal capacity <sup>2</sup>		kW		81.5	
	Power absorption		kW		22.51	
	COP				3.62	
	SCOP <sup>4</sup>				3.39	
<b>Sound pressure<sup>3</sup></b>	Operating temperature range		Indoor DB °C		15.0~27.0°C	
			Outdoor WB °C		-20.0~15.5°C	
<b>Connectable indoor units</b>			50 to 150% of capacity of O.U.		50 to 150% of capacity of O.U.	
Total capacity						
Model/Quantity			P15~P250/2~50		P15~P250/2~50	
<b>External diameter of refrigerant connectors</b>	Liquid		mm		28.58	
	Gas		mm		28.58	
<b>Model</b>			PURY-EP300YLM-A1		PURY-EP350YLM-A1	
Fan air flow rate			m <sup>3</sup> /min		230	
External dimensions (HxLxW)			mm		1710x1220x740	
Net weight			kg		260	
R410A refrigerant charge quantity			kg		9.3	

<sup>1</sup> Nominal cooling conditions: Indoor: 27°C DB / 19°C WB, Outdoor 35°C DB, Piping length 7.5 m, vertical difference 0 m.

<sup>2</sup> Nominal heating conditions: Indoor 20°C DB, Outdoor 7°C DB / 6°C WB, Piping length 7.5 m, vertical difference 0 m.

<sup>3</sup> Values measured in anechoic chamber.

<sup>4</sup> Values calculated according to EN14825 for AVERAGE (STRASBOURG) area.

<sup>5</sup> Value calculated according to EUROVENT formula.



# Series R2 Seasonal double



PURY-EP YSLM-A1 OUTDOOR UNITS  
OPTIMIZED FOR SEASONAL PERFORMANCE

E.T.C.

CONTINUOUS HEATING

FLAT TUBE

OUTDOOR UNITS



## TECHNICAL SPECIFICATIONS

MODEL			PURY-EP750YSLM-A1(-BS)		PURY-EP800YSLM-A1(-BS)	
<b>HP</b>			30		32	
<b>Power</b>	Voltage/Freq./Phases	V/Hz/n°	3 phase 380-400-415V 50Hz		3 phase 380-400-415V 50Hz	
<b>Cooling</b>	Nominal capacity <sup>1</sup>	kW	85.0		90.0	
	Power absorption	kW	25.99		25.93	
	EER		3.27		3.47	
	SEER <sup>4</sup>		5.29		5.26	
	ESEER <sup>5</sup>		5.16		5.32	
Operating temperature range	Indoor WB	°C	15.0~24.0°C		15.0~24.0°C	
	Outdoor DB	°C	-5.0~46.0°C		-5.0~46.0°C	
<b>Heating</b>	Nominal capacity <sup>2</sup>	kW	95.0		100.0	
	Power absorption	kW	26.38		26.80	
	COP		3.60		3.73	
	SCOP <sup>4</sup>		3.33		3.40	
	Operating temperature range	Indoor DB	°C	15.0~27.0°C		15.0~27.0°C
Outdoor WB		°C	-20.0~15.5°C		-20.0~15.5°C	
<b>Sound pressure<sup>3</sup></b>			65.5		65.5	
<b>Connectable indoor units</b>	Total capacity		50 to 150% of capacity of O.U.		50 to 150% of capacity of O.U.	
	Model/Quantity		P15~P250/2~50		P15~P250/2~50	
<b>External diameter of refrigerant connectors</b>	Liquid	mm	28.58		28.58	
	Gas	mm	34.93		34.93	
<b>Model</b>			<b>PURY-EP350YLM-A1</b>	<b>PURY-EP400YLM-A1</b>	<b>PURY-EP400YLM-A1</b>	<b>PURY-EP400YLM-A1</b>
	Fan air flow rate	m <sup>3</sup> /min	230	320	320	320
	External dimensions (HxLxW)	mm	1710x1220x740	1710x1750x740	1710x1750x740	1710x1750x740
	Net weight	kg	260	338	338	338
	R410A refrigerant charge quantity	kg	9.3	11.8	11.8	11.8

<sup>1</sup> Nominal cooling conditions: Indoor: 27°C DB / 19°C WB, Outdoor 35°C DB. Piping length 7.5 m, vertical difference 0 m.

<sup>2</sup> Nominal heating conditions: Indoor 20°C DB. Outdoor 7°C DB / 6°C WB. Piping length 7.5 m, vertical difference 0 m.

<sup>3</sup> Values measured in anechoic chamber.

<sup>4</sup> Values calculated according to EN14825 for AVERAGE (STRASBOURG) area.

<sup>5</sup> Value calculated according to EUROVENT formula.

# Series R2 Seasonal double



PURY-EP YSLM-A1 OUTDOOR UNITS  
OPTIMIZED FOR SEASONAL PERFORMANCE

E.T.C.

CONTINUOUS  
HEATING

FLAT TUBE



## TECHNICAL SPECIFICATIONS

MODEL			PURY-EP850YSLM-A1(-BS)		PURY-EP900YSLM-A1(-BS)	
<b>HP</b>			34		36	
<b>Power</b>	Voltage/Freq./Phases	V/Hz/n°	3 phase 380-400-415V 50Hz		3 phase 380-400-415V 50Hz	
<b>Cooling</b>	Nominal capacity <sup>1</sup>	kW	96.0		101.0	
	Power absorption	kW	28.48		30.98	
	EER		3.37		3.26	
	SEER <sup>4</sup>		5.19		5.12	
	ESEER <sup>5</sup>		5.17		5.17	
Operating temperature range	Indoor WB	°C	15.0~24.0°C		15.0~24.0°C	
	Outdoor DB	°C	-5.0~46.0°C		-5.0~46.0°C	
<b>Heating</b>	Nominal capacity <sup>2</sup>	kW	108.0		113.0	
	Power absorption	kW	29.75		32.01	
	COP		3.63		3.53	
	SCOP <sup>4</sup>		3.29		3.18	
	Operating temperature range	Indoor DB	°C	15.0~27.0°C		15.0~27.0°C
Outdoor WB		°C	-20.0~15.5°C		-20.0~15.5°C	
<b>Sound pressure<sup>3</sup></b>		dB(A)	65.5		65.5	
<b>Connectable indoor units</b>	Total capacity		50 to 150% of capacity of O.U.		50 to 150% of capacity of O.U.	
	Model/Quantity		P15-P250/2~50		P15-P250/2~50	
<b>External diameter of refrigerant connectors</b>	Liquid	mm	28.58		28.58	
	Gas	mm	41.28		41.28	
<b>Model</b>			<b>PURY-EP400YLM-A1</b>	<b>PURY-EP450YLM-A1</b>	<b>PURY-EP450YLM-A1</b>	<b>PURY-EP450YLM-A1</b>
	Fan air flow rate	m <sup>3</sup> /min	320		320	
	External dimensions (HxLxW)	mm	1710x1750x740		1710x1750x740	
	Net weight	kg	338		338	
	R410A refrigerant charge quantity	kg	11.8		11.8	

<sup>1</sup> Nominal cooling conditions: Indoor: 27°C DB / 19°C WB. Outdoor 35°C DB. Piping length 7.5 m, vertical difference 0 m.

<sup>2</sup> Nominal heating conditions: Indoor 20°C DB. Outdoor 7°C DB / 6°C WB. Piping length 7.5 m, vertical difference 0 m.

<sup>3</sup> Values measured in anechoic chamber.

<sup>4</sup> Values calculated according to EN14825 for AVERAGE (STRASBOURG) area.

<sup>5</sup> Value calculated according to EUROVENT formula.

# Y Zubadan

## Heat pump outdoor units



### Y ZUBADAN Series

CITY MULTI ZUBADAN series combines the ultimate in application flexibility and powerful cooling and heating capabilities to deliver precise comfort even in the coldest days of the year down to  $-25^{\circ}\text{C}$ . The technology behind this is a Flash Injection circuit which provides optimum amount of refrigerant to the system via a compressor through a specially designed injection port to ensure a particularly stable operation. With this, ZUBADAN can provide a full heating performance even at  $-15^{\circ}\text{C}$  and continuous heating for up to 250 minutes in one continuous cycle, ensuring a phenomenal heating performance at low temperatures.



### Stable Heating Performance even at $-15^{\circ}\text{C}$

Using an industry first "Flash-injection Circuit", the ZUBADAN System is able to provide FULL heating performance in ambient temperatures as low as  $-15^{\circ}\text{C}$ .

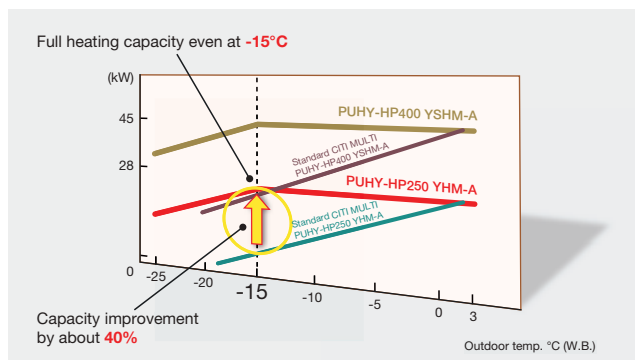

### Expanded Heating Operation down to $-25^{\circ}\text{C}$

Furthermore, from a previous LOWEST operating ambient temperature of  $-20^{\circ}\text{C}$ , the ZUBADAN System pushes the boundaries of technology to give heating in ambient temperatures as low as  $-25^{\circ}\text{C}$ .

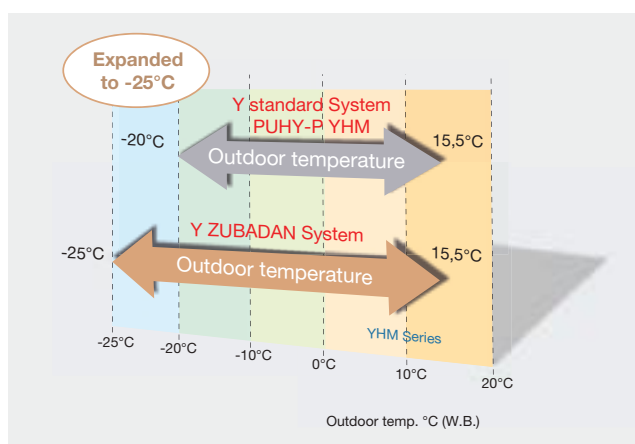

# Y Zubadan

## Heat pump outdoor units



### Shorter Warm-up in about 20 Min.

With its new improved startup performance, the ZUBADAN system achieves full heating capacity even when outdoor temperature is as low as  $-15^{\circ}\text{C}$ . Heating capacity, about 20 minutes after startup is improved by 40% compared to the conventional model; ensuring occupants an immediate comfortable air solution.

**EVEN AT  $-15^{\circ}\text{C}$ , IT REACHES THE RATED HEATING CAPACITY IN ABOUT 20 MINUTES**

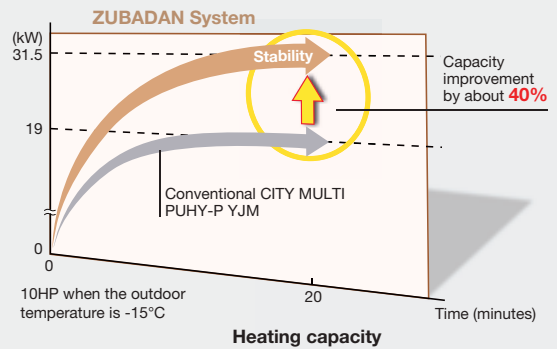

### Flash Injection Circuit

One of the key factors of the units newly designed Flash Injection Circuit is that the optimal amount of refrigerant can be provided to the system via the compressor through a specially designed injection port to ensure a particularly stable operation. In simple terms, the system allows a quick startup time and continuous heating; even in low ambient conditions.

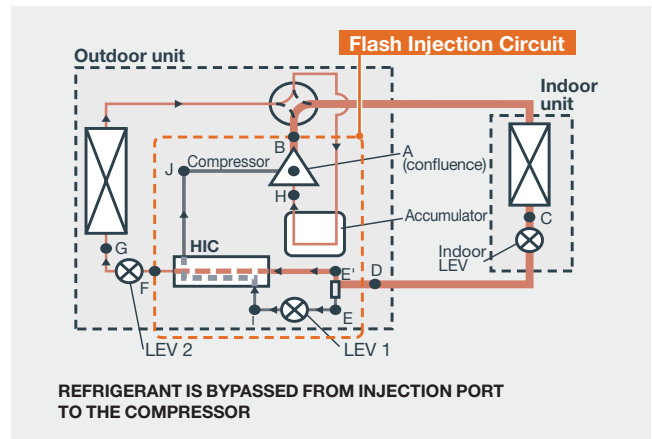

### Constant Comfort

With its new highly effective defrost feature (which prevents automatic defrosting when it is not required), the ZUBADAN System can deliver conditioned heating operation up to 250 minutes in one continuous cycle!

**HEATING CAPACITY IS MAINTAINED BY THE FLASH-INJECTION CIRCUIT.**

Heating efficiency improved by HIC

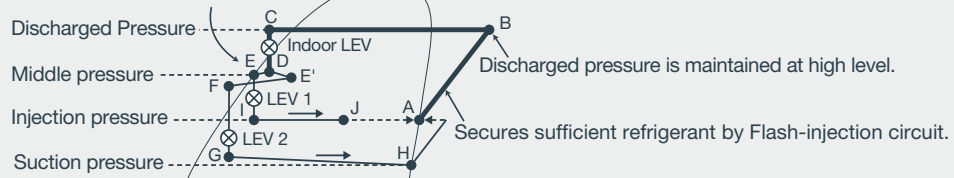

**PRESSURE ENTHALPY DIAGRAM SHOWING HIC**

TECHNICAL SPECIFICATIONS

MODEL			PUHY-HP200YHM-A(-BS)		PUHY-HP250YHM-A(-BS)	
<b>HP</b>			8		10	
<b>Power</b>	Voltage/Freq./Phases	V/Hz/n°	3 phase 380-400-415V 50Hz			
<b>Cooling</b>	Nominal capacity <sup>1</sup>	kW	22.4		28.0	
	Power absorption	kW	6.40		9.06	
	EER		3.50		3.09	
	Operating temperature range	Indoor WB °C	15.0~24.0		15.0~24.0	
	Outdoor DB °C	-5.0~43.0		-5.0~43.0		
<b>Heating</b>	Nominal capacity <sup>2</sup>	kW	25.0		31.5	
	Power absorption	kW	6.52		8.94	
	COP		3.83		3.52	
	Operating temperature range	Indoor DB °C	15.0~27.0		15.0~27.0	
	Outdoor WB °C	-25.0~15.5		-25.0~15.5		
<b>Sound pressure<sup>3</sup></b>		dB(A)	56		57	
<b>Connectable indoor units</b>	Total capacity		50 to 130% of capacity of O.U.			
	Model/Quantity		P15~P250 / 1~17		P15~P250 / 1~21	
<b>External diameter of refrigerant connectors</b>	Liquid	mm	12.7		12.7	
	Gas	mm	19.05		22.2	
	Fan air flow rate	m <sup>3</sup> /min	225		225	
	External dimensions (HxLxW)	mm	1710x920x760*		1710x920x760*	
Net weight	kg	220		220		
R410A refrigerant charge quantity	kg	9.0		9.0		

TECHNICAL SPECIFICATIONS

MODEL			PUHY-HP400YSHM-A(-BS)		PUHY-HP500YSHM-A(-BS)	
<b>HP</b>			16		20	
<b>Power</b>	Voltage/Freq./Phases	V/Hz/n°	3 phase 380-400-415V 50Hz			
<b>Cooling</b>	Nominal capacity <sup>1</sup>	kW	45.0		56.0	
	Power absorption	kW	12.86		18.16	
	EER		3.49		3.08	
	Operating temperature range	Indoor WB °C	15.0~24.0		15.0~24.0	
	Outdoor DB °C	-5.0~43.0		-5.0~43.0		
<b>Heating</b>	Nominal capacity <sup>2</sup>	kW	50.0		63.0	
	Power absorption	kW	13.35		18.04	
	COP		3.74		3.49	
	Operating temperature range	Indoor DB °C	15.0~27.0		15.0~27.0	
	Outdoor WB °C	-25.0~15.5		-25.0~15.5		
<b>Sound pressure<sup>3</sup></b>		dB(A)	59		60	
<b>Connectable indoor units</b>	Total capacity		50 to 130% of capacity of O.U.			
	Model/Quantity		P15~P250 / 1~34		P15~P250 / 1~43	
<b>External diameter of refrigerant connectors</b>	Liquid	mm	15.88		15.88	
	Gas	mm	28.58		28.58	
<b>Model</b>			PUHY-HP200YHM-A	PUHY-HP200YHM-A	PUHY-HP250YHM-A	PUHY-HP250YHM-A
	Fan air flow rate	m <sup>3</sup> /min	225	225	225	225
	External dimensions (HxLxW)	mm	1710x920x760*	1710x920x760*	1710x920x760*	1710x920x760*
	Net weight	kg	220	220	220	220
	External diameter of refrigerant connectors	Liquid	9.52	9.52	9.52	9.52
		Gas	19.05	19.05	22.2	22.2
	R410A refrigerant charge quantity	kg	9.0	9.0	9.0	9.0

\* Without removable support feet, A=1650 mm.

<sup>1</sup> Nominal cooling conditions: Indoor 27°C DB / 19°C WB, Outdoor 35°C DB, Piping length 7.5 m, vertical difference 0 m.

<sup>2</sup> Nominal heating conditions: Indoor 20°C DB, Outdoor 7°C DB / 6°C WB, Piping length 7.5 m, vertical difference 0 m.

<sup>3</sup> Values measured in anechoic chamber.

# WY and WR2 **water source** outdoor units



## Advantages

WY and WR2 series VRF CITY MULTI systems have all the benefits of the Y series, using water evaporation condensing units. Water heat source condensing units offer the advantage of being installable inside the building, for even greater installation flexibility with practically no limitations for the dimensions of the infrastructure. Depending on the capacity of the outdoor unit, up to 26 indoor units can be connected to a single condensing unit, while up to 50 indoor units can be connected to a modular system with individual user and/or centralised control. The two-pipe system allows the system to transition from heating to cooling mode and vice versa, for superior comfort in all zones.

## Geothermal applications



WY and WR2 series outdoor units are perfectly suited for geothermal applications as they use water as the thermal medium fluid which, at depths from 10 m below ground, maintains a practically constant temperature with no significant excursions all year round.

A geothermal installation uses the ground as a heat source in winter and as a heat sink in summer. Using geothermal probes (heat exchangers) together with VRF CITY MULTI WY and WR2 systems, heat may be extracted from the ground to warm in winter, and dissipated into the ground to cool in summer.

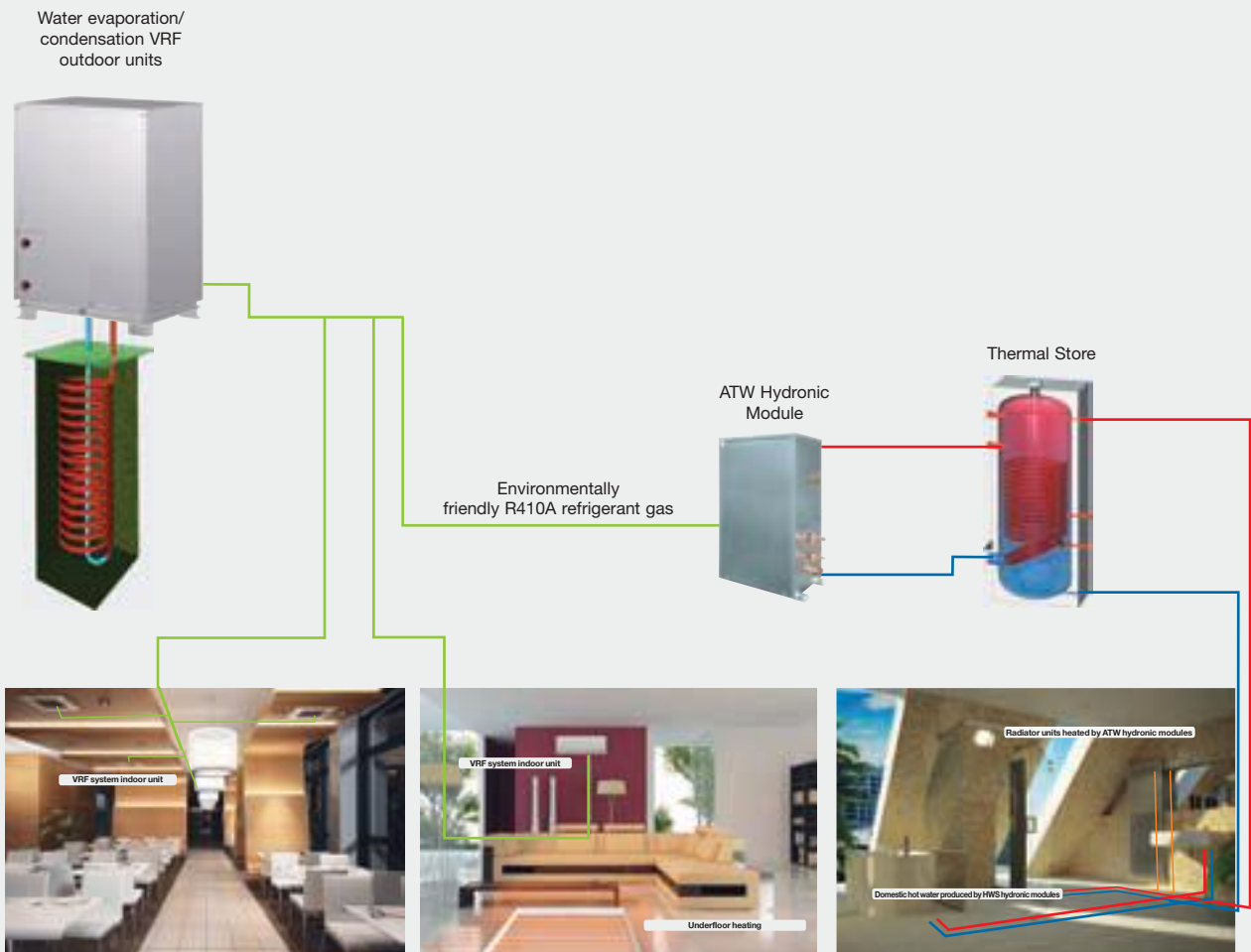
### GEOTHERMAL SYSTEM COMBINED WITH VRF CITY MULTI WY WATER SOURCE SYSTEM



TECHNICAL SPECIFICATIONS

					
MODEL			PQHY-P200YHM-A	PQHY-P250YHM-A	PQHY-P300YHM-A
<b>HP</b>			8	10	12
<b>Power</b>			3 phase 380-400-415V 50Hz		
<b>Cooling</b>	Voltage/Freq./Phases		V/Hz/n°		
	Nominal capacity <sup>2</sup>		22.4	28.0	33.5
	Power absorption		3.92	5.45	7.36
	EER		5.71	5.13	4.55
	Operating temperature range <sup>3</sup>	Indoor WB °C	15.0~24.0	15.0~24.0	15.0~24.0
		Circulating water °C	10.0~45.0	10.0~45.0	10.0~45.0
<b>Heating</b>	Nominal capacity <sup>2</sup>		25.0	31.5	37.5
	Power absorption		4.12	5.80	8.15
	COP		6.06	5.43	4.60
	Operating temperature range <sup>3</sup>	Indoor DB °C	15.0~27.0	15.0~27.0	15.0~27.0
Circulating water °C		10.0~45.0	10.0~45.0	10.0~45.0	
<b>Sound pressure<sup>4</sup></b>			47	49	50
<b>Connectable indoor units</b>	Total capacity		50 to 130% of capacity of O.U.		
	Model/Quantity		P15~P250 / 1~17	P15~P250 / 1~21	P15~P250 / 1~26
<b>External diameter of refrigerant connectors</b>	Liquid		9.52	9.52	9.52
	Gas		19.05	22.2	22.2
<b>Water in circuit</b>	Range		5.76	5.76	5.76
	Pressure drop		17	17	17
	Volume in heat exchanger		5.0	5.0	5.0
	External dimensions (HxLxW)		1160x880x550*	1160x880x550*	1160x880x550*
Net weight		195	195	195	
R410A refrigerant charge quantity		5.0	5.0	5.0	

\* Without removable support feet, A=1100 mm.

<sup>1</sup> Nominal cooling conditions: Indoor 27°C DB / 19°C WB, Water temperature 30°C. Piping length 7.5 m, vertical difference 0 m.

<sup>2</sup> Nominal heating conditions: Indoor 20°C DB, Water temperature 20°C. Piping length 7.5 m, vertical difference 0 m.



<sup>3</sup> For geothermal applications, specific software is required (contact head office) to extend the operating temperature range:



Cooling: Indoor 15°C WB to 24°C WB – Water in circuit: -5°C to 45°C.

Heating: Indoor 15°C WB to 27°C WB – Water in circuit: -5°C to 45°C.

<sup>4</sup> Values measured in anechoic chamber.

PQHY-P YSHM-A OUTDOOR UNIT

TECHNICAL SPECIFICATIONS							
MODEL			PQHY-P400YSHM-A		PQHY-P450YSHM-A		
<b>HP</b>			16		18		
<b>Power</b>	Voltage/Freq./Phases	V/Hz/n°	3 phase 380-400-415V 50Hz				
<b>Cooling</b>	Nominal capacity <sup>2</sup>	kW	45.0		50.0		
	Power absorption	kW	8.25		9.84		
	EER		5.45		5.08		
	Operating temperature range <sup>3</sup>	Indoor WB	°C	15.0~24.0		15.0~24.0	
Circulating water		°C	10.0~45.0		10.0~45.0		
<b>Heating</b>	Nominal capacity <sup>2</sup>	kW	50.0		56.0		
	Power absorption	kW	8.65		10.42		
	COP		5.78		5.37		
	Operating temperature range <sup>3</sup>	Indoor DB	°C	15.0~27.0		15.0~27.0	
Circulating water		°C	10.0~45.0		10.0~45.0		
<b>Sound pressure<sup>4</sup></b>		dB(A)	50		51		
<b>Connectable indoor units</b>	Total capacity		50 to 130% of capacity of O.U.				
	Model/Quantity		P15~P250 / 1~34		P15~P250 / 1~39		
<b>External diameter of refrigerant connectors</b>	Liquid	mm	12.7		15.88		
	Gas	mm	28.58		28.58		
<b>Water in circuit</b>	Range	m <sup>3</sup> /h	PQHY-P200YHM-A	PQHY-P200YHM-A	PQHY-P250YHM-A	PQHY-P200YHM-A	
	Pressure drop	kPa	5.76	5.76	5.76	5.76	
	Volume in heat exchanger	l	17	17	17	17	
	External dimensions (HxLxW)	mm	5.0	5.0	5.0	5.0	
	Net weight	kg	1160x880x550*	1160x880x550*	1160x880x550*	1160x880x550*	
	R410A refrigerant charge quantity	kg	195	195	195	195	
	External diameter of refrigerant connectors	Liquid	mm	9.52	9.52	9.52	9.52
		Gas	mm	19.05	19.05	22.2	22.2
	R410A refrigerant charge quantity	kg	5.0	5.0	5.0	5.0	

TECHNICAL SPECIFICATIONS									
MODEL			PQHY-P500YSHM-A		PQHY-P550YSHM-A		PQHY-P600YSHM-A		
<b>HP</b>			20		22		24		
<b>Power</b>	Voltage/Freq./Phases	V/Hz/n°	3 phase 380-400-415V 50Hz						
<b>Cooling</b>	Nominal capacity <sup>2</sup>	kW	56.0		63.0		69.0		
	Power absorption	kW	11.45		13.46		15.48		
	EER		4.89		4.68		4.45		
	Operating temperature range <sup>3</sup>	Indoor WB	°C	15.0~24.0		15.0~24.0		15.0~24.0	
Circulating water		°C	10.0~45.0		10.0~45.0		10.0~45.0		
<b>Heating</b>	Nominal capacity <sup>2</sup>	kW	63.0		69.0		76.5		
	Power absorption	kW	12.06		14.65		17.12		
	COP		5.22		4.70		4.46		
	Operating temperature range <sup>3</sup>	Indoor DB	°C	15.0~27.0		15.0~27.0		15.0~27.0	
Circulating water		°C	10.0~45.0		10.0~45.0		10.0~45.0		
<b>Sound pressure<sup>4</sup></b>		dB(A)	52		52.5		53		
<b>Connectable indoor units</b>	Total capacity		50 to 130% of capacity of O.U.						
	Model/Quantity		P15~P250 / 1~43		P15~P250 / 2~47		P15~P250 / 2~50		
<b>External diameter of refrigerant connectors</b>	Liquid	mm	15.88		15.88		15.88		
	Gas	mm	28.58		28.58		28.58		
<b>Water in circuit</b>	Range	m <sup>3</sup> /h	PQHY-P250YHM-A	PQHY-P250YHM-A	PQHY-P300YHM-A	PQHY-P250YHM-A	PQHY-P300YHM-A	PQHY-P300YHM-A	
	Pressure drop	kPa	5.76	5.76	5.76	5.76	5.76	5.76	
	Volume in heat exchanger	l	17	17	17	17	17	17	
	External dimensions (HxLxW)	mm	5.0	5.0	5.0	5.0	5.0	5.0	
	Net weight	kg	1160x880x550*	1160x880x550*	1160x880x550*	1160x880x550*	1160x880x550*	1160x880x550*	
	R410A refrigerant charge quantity	kg	195	195	195	195	195	195	
	External diameter of refrigerant connectors	Liquid	mm	9.52	9.52	12.7	12.7	12.7	12.7
		Gas	mm	22.2	22.2	22.2	22.2	22.2	22.2
	R410A refrigerant charge quantity	kg	5.0	5.0	5.0	5.0	5.0	5.0	

\* Without removable support feet, A=1100 mm.

\*<sup>1</sup> Nominal cooling conditions: Indoor 27°C DB / 19°C WB, Water temperature 30°C. Piping length 7.5 m, vertical difference 0 m.

\*<sup>2</sup> Nominal heating conditions: Indoor 20°C DB, Water temperature 20°C. Piping length 7.5 m, vertical difference 0 m.

\*<sup>3</sup> For geothermal applications, specific software is required (contact head office) to extend the operating temperature range:

Cooling: Indoor 15°C WB to 24°C WB – Water in circuit: -5°C to 45°C.

Heating: Indoor 15°C WB to 27°C WB – Water in circuit: -5°C to 45°C.

\*<sup>4</sup> Values measured in anechoic chamber.



TECHNICAL SPECIFICATIONS



MODEL			PQHY-P650YSHM-A			PQHY-P700YSHM-A			
<b>HP</b>			26			28			
<b>Power</b>	Voltage/Freq./Phases	V/Hz/n°	3 phase 380-400-415V 50Hz						
<b>Cooling</b>	Nominal capacity <sup>2</sup>	kW	73.0			80.0			
	Power absorption	kW	13.96			15.58			
	EER		5.22			5.13			
	Operating temperature range <sup>3</sup>	Indoor WB °C Circulating water °C	15.0~24.0 10.0~45.0			15.0~24.0 10.0~45.0			
<b>Heating</b>	Nominal capacity <sup>2</sup>	kW	81.5			88.0			
	Power absorption	kW	14.74			16.51			
	COP		5.52			5.33			
	Operating temperature range <sup>3</sup>	Indoor DB °C Circulating water °C	15.0~27.0 10.0~45.0			15.0~27.0 10.0~45.0			
<b>Sound pressure<sup>4</sup></b>		dB(A)	53			53.5			
<b>Connectable indoor units</b>	Total capacity		50 to 130% of capacity of O.U.						
	Model/Quantity		P15~P250 / 2~50			P15~P250 / 2~50			
<b>External diameter of refrigerant connectors</b>	Liquid	mm	19.05			19.05			
	Gas	mm	34.93			34.93			
<b>Water in circuit</b>	Range	m <sup>3</sup> /h	PQHY-P250YHM-A	PQHY-P200YJM-A	PQHY-P200YJM-A	PQHY-P250YHM-A	PQHY-P250YJM-A	PQHY-P200YJM-A	
	Pressure drop	kPa	5.76	5.76	5.76	5.76	5.76	5.76	
	Volume in heat exchanger	l	17	17	17	17	17	17	
	External dimensions (HxLxW)	mm	5.0	5.0	5.0	5.0	5.0	5.0	
	Net weight	kg	1160x880x550*	1160x880x550*	1160x880x550*	1160x880x550*	1160x880x550*	1160x880x550*	
	R410A refrigerant charge quantity	kg	195	195	195	195	195	195	
	External diameter of refrigerant connectors	Liquid	mm	12.7	12.7	12.7	12.7	12.7	12.7
		Gas	mm	22.2	19.05	19.05	22.2	22.2	19.05
	R410A refrigerant charge quantity	kg	5.0	5.0	5.0	5.0	5.0	5.0	

TECHNICAL SPECIFICATIONS



MODEL			PQHY-P750YSHM-A			PQHY-P800YSHM-A			
<b>HP</b>			30			32			
<b>Power</b>	Voltage/Freq./Phases	V/Hz/n°	3 phase 380-400-415V 50Hz						
<b>Cooling</b>	Nominal capacity <sup>2</sup>	kW	85.0			90.0			
	Power absorption	kW	17.19			19.18			
	EER		4.94			4.69			
	Operating temperature range <sup>3</sup>	Indoor WB °C Circulating water °C	15.0~24.0 10.0~45.0			15.0~24.0 10.0~45.0			
<b>Heating</b>	Nominal capacity <sup>2</sup>	kW	95.0			100.0			
	Power absorption	kW	18.27			20.74			
	COP		5.19			4.82			
	Operating temperature range <sup>3</sup>	Indoor DB °C Circulating water °C	15.0~27.0 10.0~45.0			15.0~27.0 10.0~45.0			
<b>Sound pressure<sup>4</sup></b>		dB(A)	54			54			
<b>Connectable indoor units</b>	Total capacity		50 to 130% of capacity of O.U.						
	Model/Quantity		P15~P250 / 2~50			P15~P250 / 2~50			
<b>External diameter of refrigerant connectors</b>	Liquid	mm	19.05			19.05			
	Gas	mm	34.93			34.93			
<b>Water in circuit</b>	Range	m <sup>3</sup> /h	PQHY-P250YHM-A	PQHY-P250YJM-A	PQHY-P250YJM-A	PQHY-P300YHM-A	PQHY-P250YJM-A	PQHY-P250YJM-A	
	Pressure drop	kPa	5.76	5.76	5.76	5.76	5.76	5.76	
	Volume in heat exchanger	l	17	17	17	17	17	17	
	External dimensions (HxLxW)	mm	5.0	5.0	5.0	5.0	5.0	5.0	
	Net weight	kg	1160x880x550*	1160x880x550*	1160x880x550*	1160x880x550*	1160x880x550*	1160x880x550*	
	R410A refrigerant charge quantity	kg	195	195	195	195	195	195	
	External diameter of refrigerant connectors	Liquid	mm	12.7	12.7	12.7	12.7	12.7	12.7
		Gas	mm	22.2	22.2	22.2	22.2	22.2	22.2
	R410A refrigerant charge quantity	kg	5.0	5.0	5.0	5.0	5.0	5.0	

\* Without removable support feet, A=1100 mm.

<sup>1</sup> Nominal cooling conditions: Indoor 27°C DB / 19°C WB, Water temperature 30°C. Piping length 7.5 m, vertical difference 0 m.

<sup>2</sup> Nominal heating conditions: Indoor 20°C DB, Water temperature 20°C. Piping length 7.5 m, vertical difference 0 m.

<sup>3</sup> For geothermal applications, specific software is required (contact head office) to extend the operating temperature range:

Cooling: Indoor 15°C WB to 24°C WB – Water in circuit: -5°C to 45°C.  
Heating: Indoor 15°C WB to 27°C WB – Water in circuit: -5°C to 45°C.

<sup>4</sup> Values measured in anechoic chamber.

**PQHY-P YSHM-A OUTDOOR UNIT**



**TECHNICAL SPECIFICATIONS**

MODEL			PQHY-P850YSHM-A			PQHY-P900YSHM-A			
<b>HP</b>			34			36			
<b>Power</b>	Voltage/Freq./Phases	V/Hz/n°	3 phase 380-400-415V 50Hz						
<b>Cooling</b>	Nominal capacity <sup>2</sup>	kW	96.0			101.0			
	Power absorption	kW	21.20			23.22			
	EER		4.52			4.34			
	Operating temperature range <sup>3</sup>	Indoor WB °C Circulating water °C	15.0~24.0 10.0~45.0			15.0~24.0 10.0~45.0			
<b>Heating</b>	Nominal capacity <sup>2</sup>	kW	108.0			113.0			
	Power absorption	kW	23.21			25.67			
	COP		4.65			4.40			
	Operating temperature range <sup>3</sup>	Indoor DB °C Circulating water °C	15.0~27.0 10.0~45.0			15.0~27.0 10.0~45.0			
<b>Sound pressure<sup>4</sup></b>		dB(A)	54.5			55			
<b>Connectable indoor units</b>	Total capacity		50 to 130% of capacity of O.U.						
	Model/Quantity		P15~P250 / 2~50			P15~P250 / 2~50			
<b>External diameter of refrigerant connectors</b>	Liquid	mm	19.05			19.05			
	Gas	mm	41.28			41.28			
<b>Water in circuit</b>	Range	m <sup>3</sup> /h	PQHY-P300YHM-A	PQHY-P300YJM-A	PQHY-P250YJM-A	PQHY-P300YHM-A	PUHY-EP300YJM-A	PUHY-EP300YJM-A	
	Pressure drop	kPa	5.76	5.76	5.76	5.76	5.76	5.76	
	Volume in heat exchanger	l	17	17	17	17	17	17	
	External dimensions (HxLxW)	mm	5.0	5.0	5.0	5.0	5.0	5.0	
	Net weight	kg	1160x880x550*	1160x880x550*	1160x880x550*	1160x880x550*	1160x880x550*	1160x880x550*	
	R410A refrigerant charge quantity	kg	195	195	195	195	195	195	
	External diameter of refrigerant connectors	Liquid	mm	12.7	12.7	12.7	12.7	12.7	12.7
		Gas	mm	22.2	22.2	22.2	22.2	22.2	22.2
R410A refrigerant charge quantity	kg	5.0	5.0	5.0	5.0	5.0	5.0		

\* Without removable support feet, A=1100 mm.

<sup>1</sup> Nominal cooling conditions: Indoor 27°C DB / 19°C WB, Water temperature 30°C. Piping length 7.5 m, vertical difference 0 m.

<sup>2</sup> Nominal heating conditions: Indoor 20°C DB, Water temperature 20°C. Piping length 7.5 m, vertical difference 0 m.

<sup>3</sup> For geothermal applications, specific software is required (contact head office) to extend the operating temperature range:

Cooling: Indoor 15°C WB to 24°C WB – Water in circuit: -5°C to 45°C.

Heating: Indoor 15°C WB to 27°C WB – Water in circuit: -5°C to 45°C.

<sup>4</sup> Values measured in anechoic chamber.

# Series WR2 Single

PQRY-P YHM-A OUTDOOR UNIT



## TECHNICAL SPECIFICATIONS

MODEL			PQRY-P200YHM-A	PQRY-P250YHM-A	PQRY-P300YHM-A
<b>HP</b>			8	10	12
<b>Power</b>			3 phase 380-400-415V 50Hz		
<b>Cooling</b>	Nominal capacity <sup>2</sup>	kW	22.4	28.0	33.5
	Power absorption	kW	3.96	5.51	7.44
	EER		5.65	5.08	4.50
	Operating temperature range <sup>3</sup>	Indoor WB °C Circulating water °C	15.0~24.0 10.0~45.0	15.0~24.0 10.0~45.0	15.0~24.0 10.0~45.0
<b>Heating</b>	Nominal capacity <sup>2</sup>	kW	25.0	31.5	37.5
	Power absorption	kW	4.12	5.80	8.15
	COP		6.06	5.43	4.60
	Operating temperature range <sup>3</sup>	Indoor DB °C Circulating water °C	15.0~27.0 10.0~45.0	15.0~27.0 10.0~45.0	15.0~27.0 10.0~45.0
<b>Sound pressure<sup>4</sup></b>			47	49	50
<b>Connectable indoor units</b>	Total capacity		50 to 150% of capacity of O.U.		
	Model/Quantity		P15~P250 / 1~20	P15~P250 / 1~25	P15~P250 / 1~30
<b>External diameter of refrigerant connectors</b>	Liquid	mm	15.88	19.05	19.05
	Gas	mm	19.05	22.2	22.2
<b>Water in circuit</b>	Range	m <sup>3</sup> /h	5.76	5.76	5.76
	Pressure drop	kPa	17	17	17
	Volume in heat exchanger	l	5.0	5.0	5.0
	External dimensions (HxLxW)	mm	1160x880x550*	1160x880x550*	1160x880x550*
Net weight			181	181	181
R410A refrigerant charge quantity			5.0	5.0	5.0

\* Without removable support feet, A=1100 mm.

<sup>1</sup> Nominal cooling conditions: Indoor 27°C DB / 19°C WB, Water temperature 30°C. Piping length 7.5 m, vertical difference 0 m.

<sup>2</sup> Nominal heating conditions: Indoor 20°C DB, Water temperature 20°C. Piping length 7.5 m, vertical difference 0 m.

<sup>3</sup> For geothermal applications, specific software is required (contact head office) to extend the operating temperature range:

Cooling: Indoor 15°C WB to 24°C WB – Water in circuit: -5°C to 45°C.



Heating: Indoor 15°C WB to 27°C WB – Water in circuit: -5°C to 45°C.



<sup>4</sup> Values measured in anechoic chamber.

# Series WR2 Double



## PQRY-P YSHM-A OUTDOOR UNIT

TECHNICAL SPECIFICATIONS							
MODEL			PQRY-P400YSHM-A		PQRY-P450YSHM-A		
<b>HP</b>			16		18		
<b>Power</b>	Voltage/Freq./Phases	V/Hz/n°	3 phase 380-400-415V 50Hz				
<b>Cooling</b>	Nominal capacity <sup>2</sup>	kW	45.0		50.0		
	Power absorption	kW	8.32		9.94		
	EER		5.40		5.03		
	Operating temperature range <sup>3</sup>	Indoor WB	°C	15.0~24.0		15.0~24.0	
Circulating water		°C	10.0~45.0		10.0~45.0		
<b>Heating</b>	Nominal capacity <sup>2</sup>	kW	50.0		56.0		
	Power absorption	kW	8.65		10.42		
	COP		5.78		5.37		
	Operating temperature range <sup>3</sup>	Indoor DB	°C	15.0~27.0		15.0~27.0	
Circulating water		°C	10.0~45.0		10.0~45.0		
<b>Sound pressure<sup>4</sup></b>		dB(A)	50		51		
<b>Connectable indoor units</b>	Total capacity		50 to 150% of capacity of O.U.				
	Model/Quantity		P15~P250 / 1~40		P15~P250 / 1~45		
<b>External diameter of refrigerant connectors</b>	Liquid	mm	22.2		22.2		
	Gas	mm	28.58		28.58		
<b>Water in circuit</b>	Range	m <sup>3</sup> /h	PQRY-P200YHM-A	PQRY-P200YHM-A	PQRY-P250YHM-A	PQRY-P200YHM-A	
	Pressure drop	kPa	5.76	5.76	5.76	5.76	
	Volume in heat exchanger	l	17	17	17	17	
	External dimensions (HxLxW)	mm	5.0	5.0	5.0	5.0	
	Net weight	kg	1160x880x550*	1160x880x550*	1160x880x550*	1160x880x550*	
	R410A refrigerant charge quantity	kg	181	181	181	181	
	External diameter of refrigerant connectors	Liquid	mm	19.05	19.05	19.05	19.05
		Gas	mm	-	22.2	-	22.2
	R410A refrigerant charge quantity	kg	5.0	5.0	5.0	5.0	

TECHNICAL SPECIFICATIONS									
MODEL			PQRY-P500YSHM-A		PQRY-P550YSHM-A		PQRY-P600YSHM-A		
<b>HP</b>			20		22		24		
<b>Power</b>	Voltage/Freq./Phases	V/Hz/n°	3 phase 380-400-415V 50Hz						
<b>Cooling</b>	Nominal capacity <sup>2</sup>	kW	56.0		63.0		69.0		
	Power absorption	kW	11.57		13.60		15.62		
	EER		4.84		4.63		4.41		
	Operating temperature range <sup>3</sup>	Indoor WB	°C	15.0~24.0		15.0~24.0		15.0~24.0	
Circulating water		°C	10.0~45.0		10.0~45.0		10.0~45.0		
<b>Heating</b>	Nominal capacity <sup>2</sup>	kW	63.0		69.0		76.5		
	Power absorption	kW	12.06		14.65		17.12		
	COP		5.22		4.70		4.46		
	Operating temperature range <sup>3</sup>	Indoor DB	°C	15.0~27.0		15.0~27.0		15.0~27.0	
Circulating water		°C	10.0~45.0		10.0~45.0		10.0~45.0		
<b>Sound pressure<sup>4</sup></b>		dB(A)	52		52.5		53		
<b>Connectable indoor units</b>	Total capacity		50 to 150% of capacity of O.U.						
	Model/Quantity		P15~P250 / 1~50		P15~P250 / 2~50		P15~P250 / 2~50		
<b>External diameter of refrigerant connectors</b>	Liquid	mm	22.2		28.58		28.58		
	Gas	mm	28.58		28.58		28.58		
<b>Water in circuit</b>	Range	m <sup>3</sup> /h	PQRY-P250YHM-A	PQRY-P250YHM-A	PQRY-P300YHM-A	PQRY-P250YHM-A	PQRY-P300YHM-A	PQRY-P300YHM-A	
	Pressure drop	kPa	5.76	5.76	5.76	5.76	5.76	5.76	
	Volume in heat exchanger	l	17	17	17	17	17	17	
	External dimensions (HxLxW)	mm	5.0	5.0	5.0	5.0	5.0	5.0	
	Net weight	kg	1160x880x550*	1160x880x550*	1160x880x550*	1160x880x550*	1160x880x550*	1160x880x550*	
	R410A refrigerant charge quantity	kg	181	181	181	181	181	181	
	External diameter of refrigerant connectors	Liquid	mm	19.05	19.05	19.05	19.05	19.05	19.05
		Gas	mm	-	22.2	-	22.2	-	22.2
	R410A refrigerant charge quantity	kg	5.0	5.0	5.0	5.0	5.0	5.0	

\* Without removable support feet, A=1100 mm.

\*<sup>1</sup> Nominal cooling conditions: Indoor 27°C DB / 19°C WB, Water temperature 30°C. Piping length 7.5 m, vertical difference 0 m.

\*<sup>2</sup> Nominal heating conditions: Indoor 20°C DB, Water temperature 20°C. Piping length 7.5 m, vertical difference 0 m.

\*<sup>3</sup> For geothermal applications, specific software is required (contact head office) to extend the operating temperature range:

Cooling: Indoor 15°C WB to 24°C WB – Water in circuit: -5°C to 45°C.

Heating: Indoor 15°C WB to 27°C WB – Water in circuit: -5°C to 45°C.

\*<sup>4</sup> Values measured in anechoic chamber.

# Y and R2 **Replace Multi** outdoor units

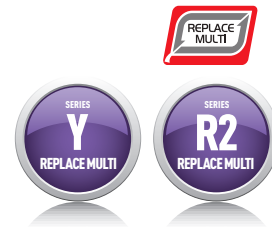

## Replace Multi Series: 3-R of the new system dedicated to the replacement of plant VRF R22

The Mitsubishi Electric solution for the replacement market of VRF R22 systems is characterized by the 3-R: **Re**-use, **Re**-placement and **Re**-newal. The innovative **Replace Multi** solution of Mitsubishi Electric makes it possible to reuse components and structural elements of existing plant rather than completely replace all units and refrigerant lines. This raises the owner from discomforts of the complete replacement of the air conditioning system (for example, new pipes, the destruction walls and stopping of the activities and business during the renovations).

### Short and quick construction process and time

Compared to the installation process and time to install a complete new system, Replace Multi offers shorter and quicker installation. The key cause of this is because with Replace Multi, without any use of special kit, existing piping can be reused and works at rooftop or walls for new piping are not required. This results in reduced installation time and system downtime which is an attractive factor to minimize the effect on business working hours.

✓...Reusable X...Not reusable

	Refrigerant pipes	Power circuits	Switches	Trasmission lines	Remote controls trasmission circuit	Outdoor unit	Indoor unit
Reuse	✓	✓	✓	✓	✓	X	X*

NOTE: The actual reusability of components depends upon the condition of the plant and the existing infrastructure.

\* The actual reusability of indoor units depends on the model. For further clarification please contact the sales office nearest you.

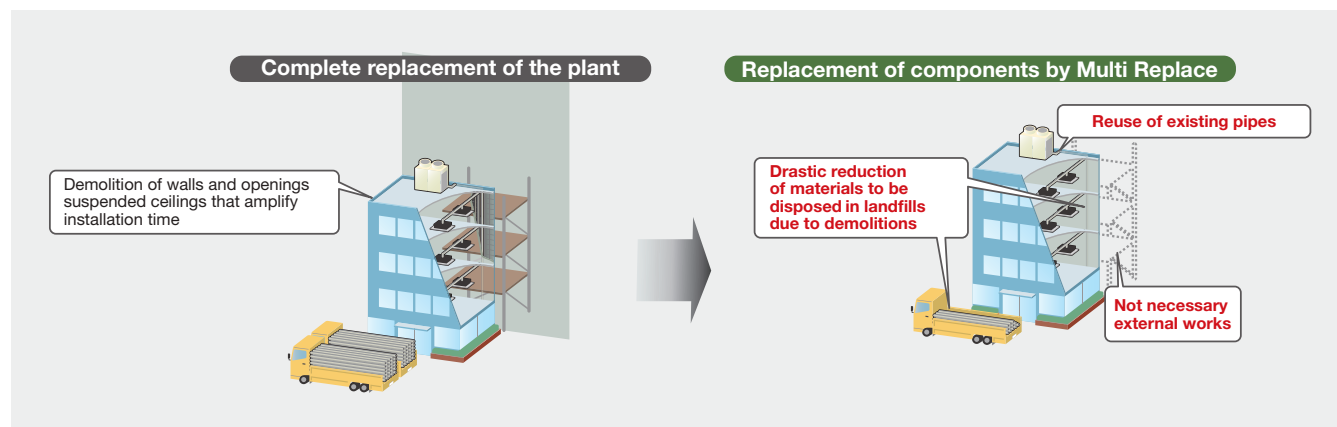

### Short and quick construction process and time

Compared to the installation process and time to install a complete new system, Replace Multi offers shorter and quicker installation. The key cause of this is because with Replace Multi, without any use of special kit, existing piping can be reused and works at rooftop or walls for new piping are not required. This results in reduced installation time and system downtime which is an attractive factor to minimize the effect on business working hours.

### Renewal for top performance

The installation of a Replace Multi system allows to achieve the state of the art of VRF technology from Mitsubishi Electric which it reached levels of energy efficiency (COP) more than 40% compared to a R22 VRF system of 10 years ago. The greater energy efficiency also means lower noise levels and reduced installation space compared to a VRF R22.



## PUHY-RP YJM-B OUTDOOR UNIT

## TECHNICAL SPECIFICATIONS

MODEL			PUHY-RP200YJM-B(-BS)	PUHY-RP250YJM-B(-BS)
<b>HP</b>			8	10
<b>Power</b>	Voltage/Freq./Phases	V/Hz/n°	3 phase 380-400-415V 50Hz	
<b>Cooling</b>	Nominal capacity <sup>1</sup>	kW	22.4	28.0
	Power absorption	kW	5.68	7.62
	EER		3.94	3.67
	Operating temperature range	Indoor WB °C Outdoor DB °C	15.0~24.0 -5.0~43.0	15.0~24.0 -5.0~43.0
<b>Heating</b>	Nominal capacity <sup>2</sup>	kW	25.0	31.5
	Power absorption	kW	5.69	7.22
	COP		4.39	4.36
	Operating temperature range	Indoor DB °C Outdoor WB °C	15.0~27.0 -20.0~15.5	15.0~27.0 -20.0~15.5
<b>Sound pressure<sup>3</sup></b>		dB(A)	56	57
<b>Connectable indoor units</b>	Total capacity		50 to 130% of capacity of O.U.	
	Model/Quantity		P15~P250 / 1~17	P15~P250 / 1~21
<b>External diameter of refrigerant connectors</b>	Liquid	mm	12.7	12.7
	Gas	mm	28.58	28.58
	Fan air flow rate	m <sup>3</sup> /min	185	185
	External dimensions (HxLxW)	mm	1710x920x760*	1710x920x760*
	Net weight	kg	230	255
	R410A refrigerant charge quantity	kg	6.5	9.0

## TECHNICAL SPECIFICATIONS

MODEL			PUHY-RP300YJM-B(-BS)	PUHY-RP350YJM-B(-BS)
<b>HP</b>			12	14
<b>Power</b>	Voltage/Freq./Phases	V/Hz/n°	3 phase 380-400-415V 50Hz	
<b>Cooling</b>	Nominal capacity <sup>1</sup>	kW	33.5	40.0
	Power absorption	kW	8.98	11.79
	EER		3.73	3.39
	Operating temperature range	Indoor WB °C Outdoor DB °C	15.0~24.0 -5.0~43.0	15.0~24.0 -5.0~43.0
<b>Heating</b>	Nominal capacity <sup>2</sup>	kW	37.5	45.0
	Power absorption	kW	9.42	12.60
	COP		3.98	3.57
	Operating temperature range	Indoor DB °C Outdoor WB °C	15.0~27.0 -20.0~15.5	15.0~27.0 -20.0~15.5
<b>Sound pressure<sup>3</sup></b>		dB(A)	59	60
<b>Connectable indoor units</b>	Total capacity		50 to 130% of capacity of O.U.	
	Model/Quantity		P15~P250 / 1~26	P15~P250 / 1~30
<b>External diameter of refrigerant connectors</b>	Liquid	mm	12.7	15.88
	Gas	mm	28.58	34.93
	Fan air flow rate	m <sup>3</sup> /min	185	185
	External dimensions (HxLxW)	mm	1710x920x760*	1710x920x760*
	Net weight	kg	255	255
	R410A refrigerant charge quantity	kg	9.0	9.0

\* Without removable support feet, A=1650 mm.

<sup>1</sup> Nominal cooling conditions: Indoor 27°C DB / 19°C WB, Outdoor 35°C DB, Piping length 7.5 m, vertical difference 0 m.<sup>2</sup> Nominal heating conditions: Indoor 20°C DB, Outdoor 7°C DB / 6°C WB, Piping length 7.5 m, vertical difference 0 m.<sup>3</sup> Values measured in anechoic chamber.

# Series R2 Replace Multi single

PURY-P YJM-B OUTDOOR UNIT



## TECHNICAL SPECIFICATIONS

MODEL			PURY-RP200YJM-B(-BS)	PURY-RP250YJM-B(-BS)	PURY-RP300YJM-B(-BS)
<b>HP</b>			8	10	12
<b>Power</b>	Voltage/Freq./Phases	V/Hz/n°	3 phase 380-400-415V 50Hz		
<b>Cooling</b>	Nominal capacity <sup>1</sup>	kW	22.4	28.0	33.5
	Power absorption	kW	4.95	6.82	8.35
	EER		4.52	4.10	4.01
	Operating temperature range	Indoor WB	°C	15.0~24.0	15.0~24.0
Outdoor DB		°C	-5.0~43.0	-5.0~43.0	-5.0~43.0
<b>Heating</b>	Nominal capacity <sup>2</sup>	kW	25.0	31.5	37.5
	Power absorption	kW	5.50	7.22	8.70
	COP		4.54	4.36	4.31
	Operating temperature range	Indoor DB	°C	15.0~27.0	15.0~27.0
Outdoor WB		°C	-20.0~15.5	-20.0~15.5	-20.0~15.5
<b>Sound pressure<sup>3</sup></b>			56	57	59
<b>Connectable indoor units</b>	Total capacity		50 to 130% of capacity of O.U.		
	Model/Quantity		P15~P250 / 1~20	P15~P250 / 1~25	P15~P250 / 1~30
<b>External diameter of refrigerant connectors</b>	Liquid	mm	19.05	19.05	19.05
	Gas	mm	28.58	28.58	28.58
	Fan air flow rate	m <sup>3</sup> /min	225	225	225
	External dimensions (HxLxW)	mm	1710x1220x760*	1710x1220x760*	1710x1220x760*
	Net weight	kg	275	290	290
R410A refrigerant charge quantity			kg	11.8	11.8

\* Without removable support feet, A=1650 mm.

<sup>1</sup> Nominal cooling conditions: Indoor 27°C DB / 19°C WB, Outdoor 35°C DB. Piping length 7.5 m, vertical difference 0 m.

<sup>2</sup> Nominal heating conditions: Indoor 20°C DB. Outdoor 7°C DB / 6°C WB. Piping length 7.5 m, vertical difference 0 m.

<sup>3</sup> Values measured in anechoic chamber.

# CITY MULTI

## BC controllers for R2-WR2 series



### The BC controller, the heart of the R2/WR2 series



The BC controller of the CMB-P-V-G connects up to 16 indoor units to the outdoor unit and ensures optimum distribution of the refrigerant depending on the operating mode of the indoor units (heating or cooling). The controller contains the high efficiency gas/liquid separator developed by Mitsubishi Electric and precisely separates the gas phase used for heating from the liquid phase used for cooling.

To allow for greater height differences and increase the maximum possible piping length, the controller uses an overcooling heat exchanger which further cools the refrigerant liquid delivered to the indoor units in cooling mode.

### Design and production

New technology used in the design and production of refrigeration circuits has made it possible to achieve superior performance together with simpler pipeline layouts. Simpler configurations for the refrigeration circuit contribute to increasing the overall reliability

of the system. The new approach used for construction limits pressure losses and reduces the overall weight of the indoor units, as well as simplifying the configuration of the entire circuit.

R2 SOLENOID VALVES

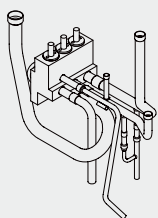

R2 CHECK VALVES

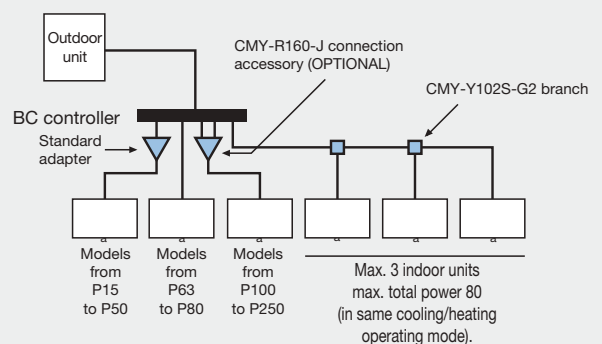
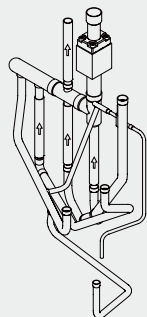





**TECHNICAL SPECIFICATIONS**

MODEL	CMB-P104V-G1	CMB-P105V-G1	CMB-P106V-G1	CMB-P108V-G1	CMB-P1010V-G1	CMB-P1013V-G1	CMB-P1016V-G1*2			
<b>Number of branches</b>	4	5	6	8	10	13	16			
<b>Power</b>	~220/230/240V 50Hz/60Hz									
<b>Power absorption</b>	Cooling	50Hz	kW	0.067/0.076/0.085	0.082/0.093/0.104	0.097/0.110/0.123	0.127/0.144/0.161	0.156/0.177/0.198	0.201/0.288/0.255	0.246/0.279/0.312
	Heating	50Hz	kW	0.030/0.034/0.038	0.038/0.043/0.048	0.045/0.051/0.057	0.060/0.068/0.076	0.075/0.085/0.095	0.097/0.110/0.123	0.119/0.135/0.151
	Cooling	60Hz	kW	0.054/0.061/0.067	0.066/0.074/0.082	0.078/0.088/0.097	0.102/0.115/0.127	0.126/0.141/0.156	0.162/0.182/0.201	0.198/0.222/0.246
	Heating	60Hz	kW	0.024/0.027/0.030	0.030/0.034/0.038	0.036/0.041/0.045	0.048/0.054/0.060	0.060/0.068/0.075	0.078/0.088/0.097	0.096/0.108/0.119
<b>Current</b>	Cooling	50Hz	A	0.31/0.34/0.36	0.38/0.41/0.44	0.45/0.48/0.52	0.58/0.63/0.68	0.71/0.77/0.83	0.92/1.00/1.07	1.12/1.22/1.30
	Heating	50Hz	A	0.14/0.15/0.16	0.18/0.19/0.20	0.21/0.23/0.24	0.28/0.30/0.32	0.35/0.37/0.40	0.45/0.48/0.52	0.55/0.59/0.63
	Cooling	60Hz	A	0.25/0.27/0.28	0.30/0.33/0.35	0.36/0.39/0.41	0.47/0.50/0.53	0.58/0.62/0.65	0.74/0.80/0.84	0.90/0.97/1.03
	Heating	60Hz	A	0.11/0.12/0.13	0.14/0.15/0.16	0.17/0.18/0.19	0.22/0.24/0.25	0.28/0.30/0.32	0.36/0.39/0.41	0.44/0.47/0.50
External finish	Galvanised									
Capacity of indoor unit connectable to 1 branch*1	R2 / WR2: P80 model or smaller									
Connectable outdoor units	See table of permissible combinations for R2/RW2 series BC controller									
Height	mm	284								
Width	mm	648			1098					
Depth	mm	432								
Drain pipe	VP-25									
Net weight	kg	24	27	28	33	38	45	52		
Accessories	<ul style="list-style-type: none"> <li>• Drain connection pipe (with flexible pipe and insulation)</li> <li>• Adapter</li> </ul>									

		CONNECTIONS		
<b>Refrigerant pipe diameter</b>	To outdoor unit	See table of permissible combinations for R2/RW2 series BC controller		
		P200	P250, P300	P350
	High press. pipe.	ø15.88 mm, brazed	ø19.05 mm, brazed	ø19.05 mm, brazed
	Low press. pipe.	ø19.05 mm, brazed	ø22.2 mm, brazed	ø28.58 mm, brazed
	To indoor unit	Liquid pipe	ø9.52 mm, swaged (ø6.35 mm using connected standard adapter, ø12.7 using optional pipe joint)	
Gas pipe		ø15.88 mm, swaged (ø12.7 mm using connected standard adapter, ø19.05 using optional pipe joint)		

\*1 Use the optional pipe joint to join 2 branches if the total capacity of the unit exceeds P140. Use the adapter (standard accessory) when connecting a P50 or smaller indoor unit.

\*2 CMB-P1016V SOLO per P700-P800.

• Additional pipes must be used to connect with P300 or smaller outdoor units.

# BC controller



## TECHNICAL SPECIFICATIONS

MODEL	CMB-P108V-GA1	CMB-P1010V-GA1	CMB-P1013V-GA1	CMB-P1016V-GA1	CMB-P1016V-HA1**		
<b>Number of branches</b>	8	10	13	16			
<b>Power</b>	~220/230/240V 50Hz/60Hz						
<b>Power absorption</b>	Cooling	50Hz	kW	0.127/0.144/0.161	0.156/0.177/0.198	0.201/0.228/0.255	0.246/0.279/0.312
	Heating	50Hz	kW	0.060/0.068/0.076	0.075/0.085/0.095	0.097/0.110/0.123	0.119/0.135/0.151
	Cooling	60Hz	kW	0.102/0.115/0.127	0.126/0.141/0.156	0.162/0.182/0.201	0.198/0.222/0.246
	Heating	60Hz	kW	0.048/0.054/0.060	0.060/0.068/0.075	0.078/0.088/0.097	0.096/0.108/0.119
<b>Current</b>	Cooling	50Hz	A	0.58/0.63/0.68	0.71/0.77/0.83	0.92/1.00/1.07	1.12/1.22/1.30
	Heating	50Hz	A	0.28/0.30/0.32	0.35/0.37/0.40	0.45/0.48/0.52	0.55/0.59/0.63
	Cooling	60Hz	A	0.47/0.50/0.53	0.58/0.62/0.65	0.74/0.80/0.84	0.90/0.97/1.03
	Heating	60Hz	A	0.22/0.24/0.25	0.28/0.30/0.32	0.36/0.39/0.41	0.44/0.47/0.50
External finish				Galvanised		Galvanized steel plate	
Capacity of indoor unit connectable to 1 branch*1	R2 / WR2: P80 model or smaller						
Connectable outdoor units	See table of permissible combinations for R2/RW2 series BC controller						
Height	mm				289		
Width	mm				1,110		
Depth	mm				520		
Drain pipe				VP-25			
Net weight	kg	43	48	55	62	69	
Accessories				<ul style="list-style-type: none"> <li>• Drain connection pipe (with flexible pipe and insulation)</li> <li>• Adapter</li> </ul>			

		CONNECTIONS						
<b>Refrigerant pipe diameter</b>	To outdoor unit	Capacity of connectable outdoor unit						
			P200	P250~300	P350	P400~P500	P550~P650	P700~P800*1
		High pressure gas pipe	ø15.88 brazed	ø19.05 brazed	ø19.05 brazed	ø22.2 brazed	ø28.58 brazed	ø28.58 brazed
	Low pressure gas pipe	ø19.05 brazed	ø22.2 brazed	ø28.58 brazed	ø28.58 brazed	ø28.58 brazed	ø34.93 brazed	
	To indoor unit	Liquid pipe	ø9.52 mm, swaged (ø6.35 mm using connected standard adapter, ø12.7 using optional pipe joint)					
		Drain pipe	ø15.88 mm, swaged (ø12.7 mm using connected standard adapter, ø19.05 using optional pipe joint)					
	To another BC controller	Total capacity of indoor units connected to secondary BC controller						
			~P200	P201~P300	P301~P350	P351~P400	P401~P450	
		High pressure gas pipe	ø15.88 brazed	ø19.05 brazed	ø19.05 brazed	ø22.2 brazed	ø22.2 brazed	
		Low pressure gas pipe	ø19.05 brazed	ø22.2 brazed	ø28.58 brazed	ø28.58 brazed	ø28.58 brazed	
	Liquid pipe	ø9.52 brazed	ø9.52 brazed	ø12.7 brazed	ø12.7 brazed	ø15.88 brazed		
Drain pipe				VP-25				
Net weight		43	48	55	62	69		
Accessories				<ul style="list-style-type: none"> <li>• Drain connection pipe (with flexible pipe and insulation)</li> <li>• Adapter</li> </ul>				

\*1 Use the optional pipe joint to join 2 branches if the total capacity of the unit exceeds P140.

Use the adapter (standard accessory) when connecting a P50 or smaller indoor unit.

\*\* CMB-P1016V for P700-P800 ONLY.

• Additional pipes must be used to connect with P300 or smaller outdoor units.



## TECHNICAL SPECIFICATIONS

MODEL		CMB-P104V-GB1	CMB-P108V-GB1	CMB-P1016V-HB1*2
Number of branches		4	8	16
POWER		~220/230/240V 50Hz/60Hz		
Power absorption	Cooling 50Hz	kW 0.060/0.068/0.076	0.119/0.135/0.151	0.237/0.269/0.301
	Heating 50Hz	kW 0.030/0.034/0.038	0.060/0.068/0.076	0.119/0.135/0.151
	Cooling 60Hz	kW 0.048/0.054/0.060	0.096/0.108/0.119	0.192/0.216/0.237
	Heating 60Hz	kW 0.024/0.027/0.030	0.048/0.054/0.060	0.096/0.108/0.120
Current	Cooling 50Hz	A 0.28/0.30/0.32	0.55/0.59/0.63	1.08/1.17/1.26
	Heating 50Hz	A 0.14/0.15/0.16	0.28/0.30/0.32	0.55/0.59/0.63
	Cooling 60Hz	A 0.22/0.24/0.25	0.44/0.47/0.50	0.88/0.94/0.99
	Heating 60Hz	A 0.11/0.12/0.13	0.22/0.24/0.25	0.44/0.47/0.50
External finish		Galvanized steel plate		
Capacity of indoor unit connectable to 1 branch*1		R2 / WR2: P80 model or smaller		
Connectable outdoor units		See table of permissible combinations for R2/RW2 series BC controller		
Height	mm	284		284
Width	mm	648		1,098
Depth	mm	432		432
Drain pipe		VP-25		
Net weight	kg	22	32	57
Accessories		<ul style="list-style-type: none"> <li>• Drain connection pipe (with flexible pipe and insulation)</li> <li>• Adapter</li> </ul>		

		CONNECTIONS					
Refrigerant pipe diameter	To main BC controller	Total capacity of indoor units connected to secondary BC controller					
		~P200	P201~P300	P301~P350	P351~P400	P401~P450	
		High pressure gas pipe	ø15.88 brazed	ø19.05 brazed	ø19.05 brazed	ø22.2 brazed	ø22.2 brazed
		Low pressure gas pipe	ø19.05 brazed	ø22.2 brazed	ø28.58 brazed	ø28.58 brazed	ø28.58 brazed
	Liquid pipe	ø9.52 brazed	ø9.52 brazed	ø12.7 brazed	ø12.7 brazed	ø15.88 brazed	
	To indoor unit	Liquid pipe	ø9.52 mm, swaged (ø6.35 mm using connected standard adapter, ø12.7 using optional pipe joint)				
	gas pipe	ø15.88 mm, swaged (ø12.7 mm using connected standard adapter, ø19.05 using optional pipe joint)					

**Table of permissible combinations for BC controllers for R2 series**

	P200,250,300,350	P400-650	P700-900
CMB-P V-G	○	×	×
CMB-P V-GA	○	○	×
CMB-P V-HA	×	×	○
CMB-P V-GB	○	○	○
CMB-P V-HB	○	○	○

**Table of permissible combinations for BC controllers for WR2 series**

	P200,250,300,350	P400-650
CMB-P V-G	○	×
CMB-P V-GA	○	○
CMB-P V-HA	×	×
CMB-P V-GB	○	○
CMB-P V-HB	×	×

\*1 Use the optional pipe joint to join 2 branches if the total capacity of the unit exceeds P140. Use the adapter (standard accessory) when connecting a P50 or smaller indoor unit.

\*2 CMB-P1016V for P700-P800 ONLY.

• Additional pipes must be used to connect with P300 or smaller outdoor units.

# CITY MULTI

## WCB water-refrigerant connection box for R2-WR2 series



### WCB refrigerant – water connection box

The WCB refrigerant-water connection box is effectively a simplified BC controller. The WCB has 2 branches only (standard indoor units / PWFY) and is specifically intended to permit air cooling functionality via the ‘indoor unit’ branch and domestic and heating hot water production functionality via the ‘PWFY’ branch.

While the WCB does not permit simultaneous heating and cooling operation of the indoor units connected to the ‘indoor unit’ branch, it does allow heat recovery in summer between the two branches, for practically free domestic hot water production.

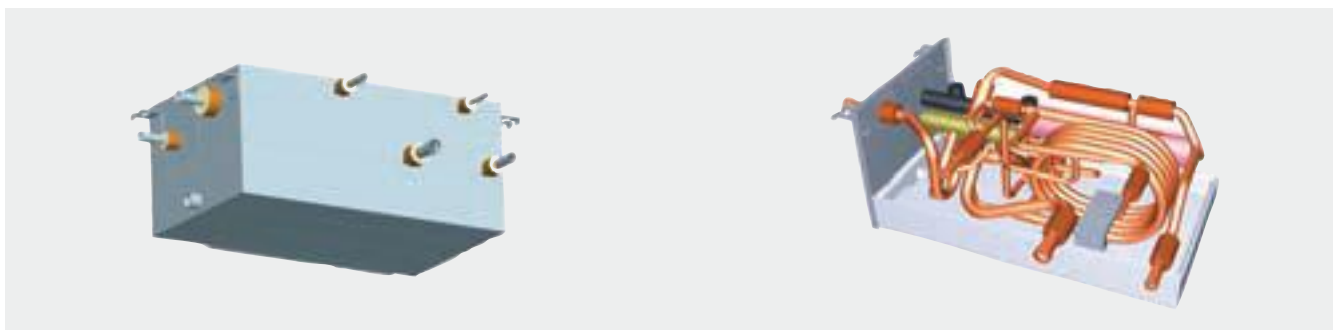

The WCB water connection box may be used to feed a mixed R2 system (HWS and ATW hydronic modules in combination with standard indoor units), allowing the following scenarios:

	ATW	HWS	Indoor Units
<b>Application</b>	<b>Primary heating with underfloor system</b>	<b>Domestic hot water production</b>	<b>Air cooling or heating</b>
<b>WINTER</b>	ON	ON	OFF
<b>AUTUMN/SPRING</b>	OFF	ON	ON
<b>SUMMER</b>	OFF	ON	ON

**Notes:** HWS and ATW hydronic modules may have a capacity index of up to 100% relative to the outdoor unit, and have priority over the indoor units. Normally, in systems with an IU/OU ratio exceeding 100%, when the hydronic modules are operating, it will only be possible for the indoor units to function which, combined with the hydronic modules, will not exceed a capacity of 130% that of the outdoor unit (130% OU – 100% HWS & ATW = max. 30% for IUs). To facilitate summer operation, with opposing loads such

as simultaneous DHW production and indoor cooling via the IUs, the 200% extended capacity function of the outdoor unit may be activated on request:

Heat to be removed from ambient → 100% UI in cooling mode + heat to be produced → 100% HWS = 100% EU with cooling and practically free DHW production.



## TECHNICAL SPECIFICATIONS

<b>MODEL</b>		<b>CMB-PW202V-J</b>		
<b>Number of branches</b>		2		
<b>Power</b>		1 phase 220/230/240VAC 50/60 Hz		
		50Hz	60Hz	
<b>Power absorption</b>	Cooling	kW	0.019/0.020/0.021	0.018/0.019/0.019
	Heating	kW	0.020/0.022/0.024	0.019/0.020/0.021
<b>Current</b>	Cooling	A	0.09/0.09/0.09	0.09/0.09/0.09
	Heating	A	0.10/0.10/0.10	0.09/0.09/0.09
External finish		Galvanized		
Connectable outdoor units		PURY-(E)P200/250/300/350YHM-A (-BS), PQRY-P200/250/300YHM-A (-BS)		
<b>Capacity of connectable indoor unit</b>	Total	50 to 130% of outdoor unit capacity		
	Indoor unit branch	Up to 130% of outdoor unit capacity		
	PWFY branch	Up to 100% of outdoor unit capacity		
<b>Dimensions</b>	HxLxW	mm	284 x 648 x 432	
Drain pipe		ø28.58 brazed		
Net weight		kg	0.D. 32 mm	

		CONNECTIONS					
<b>Refrigerant pipe diameter</b>	To outdoor unit	See capacity of connectable outdoor unit					
			P200	P250~300	P350		
		High press. pipe.	ø15.88 brazed	ø19.05 brazed	ø19.05 brazed		
		Low press. pipe.	ø19.05 brazed	ø22.2 brazed	ø28.58 brazed		
To indoor unit	See total capacity of subsequent indoor units						
		~ P140	P141~P200	P201~P300	P301~P400	P401~	
		Liquid pipe	ø9.52 brazed	ø9.52 brazed	ø9.52 brazed	ø15.88 brazed	ø15.88 brazed
		Gas pipe	ø15.88 brazed	ø19.05 brazed	ø22.2 brazed	ø28.58 brazed	ø28.58 brazed

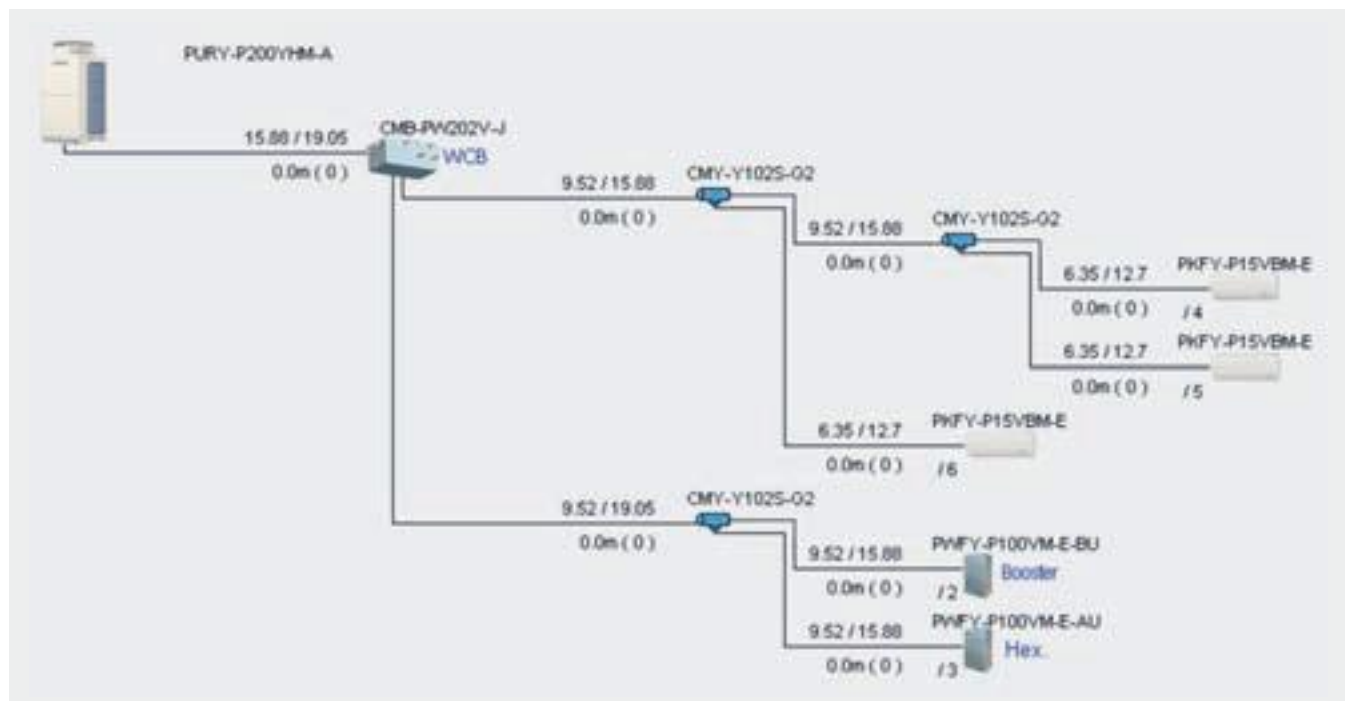

# CITY MULTI

## Model code

### CITY MULTI outdoor units

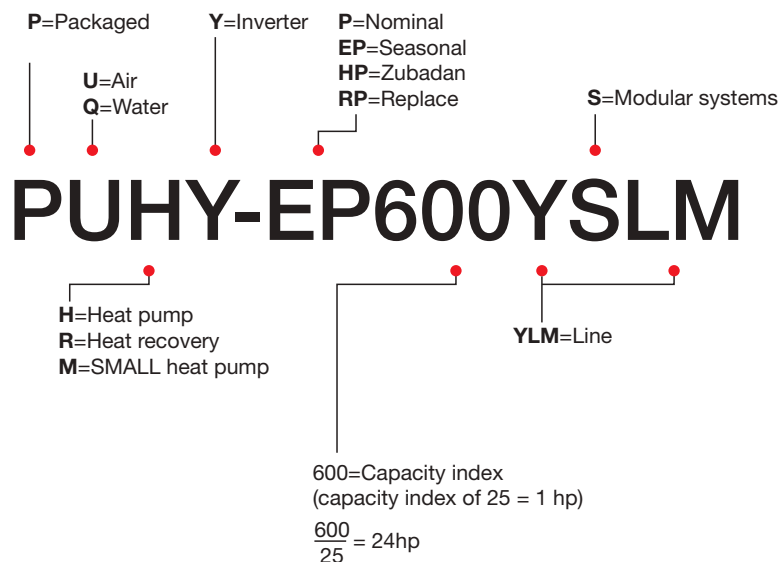

### CITY MULTI Indoor units

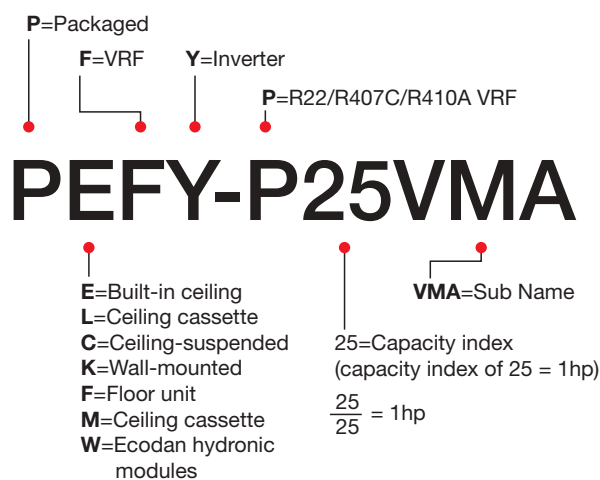

### BC Controller

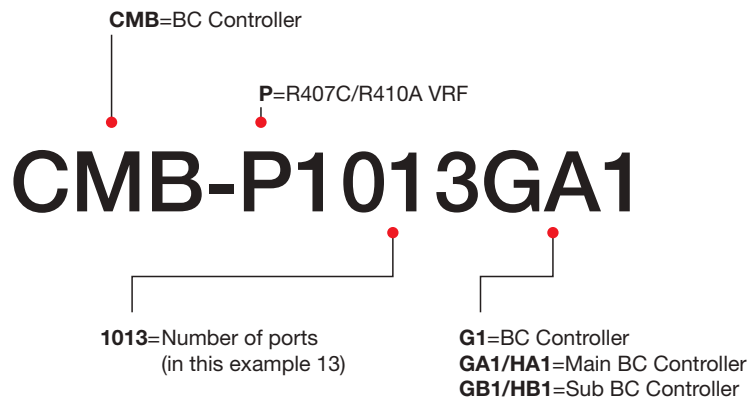

# CITY MULTI

# Refrigerant piping length

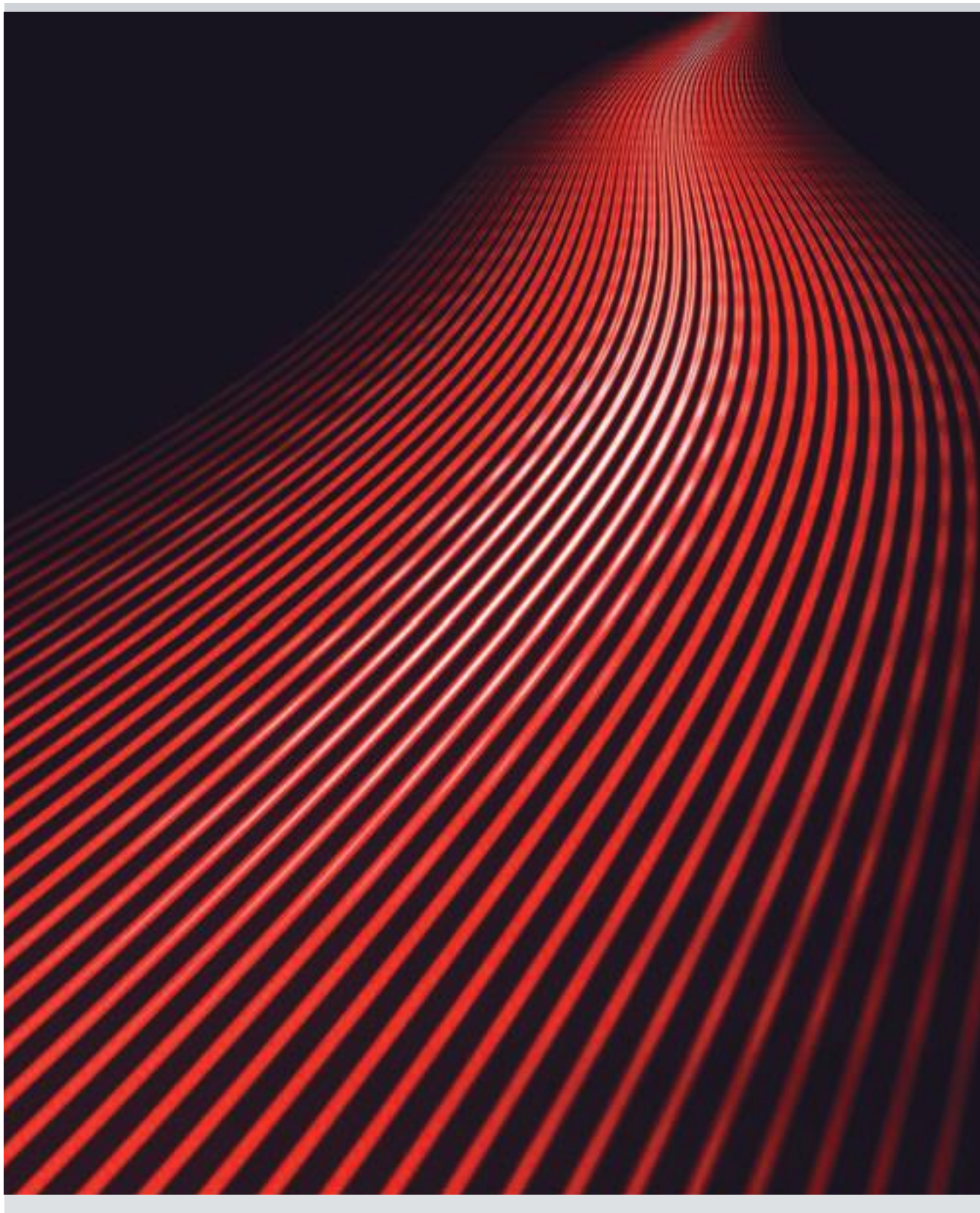

## Series SMALL Y (PUMY-P-YKM2/VKM2)



### GEOMETRIC LIMITS OF REFRIGERATION PIPELINES

Total effective length	max. 300 m
Effective length of a single circuit	max. 150 m
Effective length after first branch	max. 30 m

### VERTICAL DIFFERENCE BETWEEN UNITS

Indoor/outdoor (outdoor unit in higher position)	max. 50 m
Indoor/outdoor (indoor unit in higher position)	max. 40 m
Indoor/Indoor	max. 15 m

Indicative values only – See technical handbook for installation details.

\*1 Use optional deflectors if the outdoor unit is installed in a location subject to high winds.

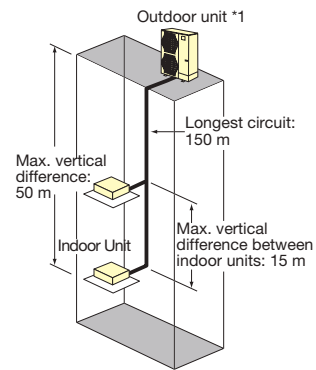

## Series SMALL Y (PUMY-P-YKM)



### GEOMETRIC LIMITS OF REFRIGERATION PIPELINES

Total effective length	max. 150 m
Effective length of a single circuit	max. 80 m
Effective length after first branch	max. 30 m

### VERTICAL DIFFERENCE BETWEEN UNITS

Indoor/outdoor (outdoor unit in higher position)	max. 50 m
Indoor/outdoor (indoor unit in higher position)	max. 40 m
Indoor/Indoor	max. 15 m

Indicative values only – See technical handbook for installation details.

\*1 Use optional deflectors if the outdoor unit is installed in a location subject to high winds.

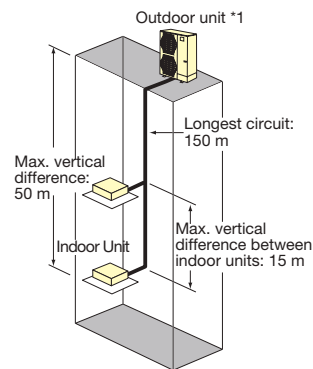

## Series Y ECOSTANDARD SINGLE (PUHY-P200-500YKA)



### GEOMETRIC LIMITS OF REFRIGERATION PIPELINES

Total effective length	max. 1000 m
Effective length of a single circuit	max. 165 m
Equivalent length of a single circuit	max. 190 m
Effective length after first branch	max. 90 m *1

### VERTICAL DIFFERENCE BETWEEN UNITS

Indoor/outdoor (outdoor unit in higher position)	max. 50 m *2
Indoor/outdoor (indoor unit in higher position)	max. 40 m *3
Indoor/Indoor	max. 30 m *4

Indicative values only – See technical handbook for installation details.

\*1 For lengths exceeding 40 m, a larger diameter liquid pipe must be used.

\*2 A max. length of 90 m is possible for certain models and in certain installation conditions. Contact head office for more details.

\*3 A max. length of 60 m is possible for certain models and in certain installation conditions. Contact head office for more details.

\*4 For vertical differences exceeding 15 m, a larger diameter liquid pipe must be used

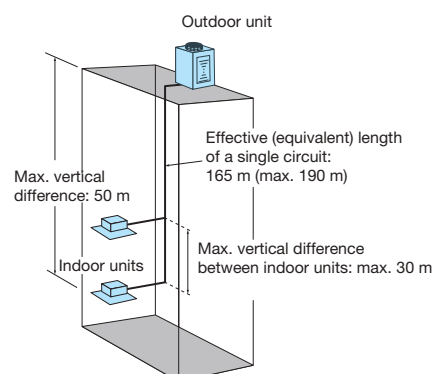



## Series Y ECOSTANDARD DOUBLE (PUHY-P550-1000YKA)

### GEOMETRIC LIMITS OF REFRIGERATION PIPELINES

Total effective length	max. 1000 m
Effective length of a single circuit	max. 165 m
Equivalent length of a single circuit	max. 190 m
Effective length after first branch	max. 90 m *1
Effective length between outdoor units	max. 10 m

### VERTICAL DIFFERENCE BETWEEN UNITS

Indoor/outdoor (outdoor unit in higher position)	max. 50 m *2
Indoor/outdoor (indoor unit in higher position)	max. 40 m *3
Indoor/Indoor	max. 30 m *4
Between outdoor units	max. 0,1 m

Indicative values only – See technical handbook for installation details.

\*1 For lengths exceeding 40 m, a larger diameter liquid pipe must be used.

\*2 A max. length of 90 m is possible for certain models and in certain installation conditions. Contact head office for more details.

\*3 A max. length of 60 m is possible for certain models and in certain installation conditions. Contact head office for more details.

\*4 For vertical differences exceeding 15 m, a larger diameter liquid pipe must be used.

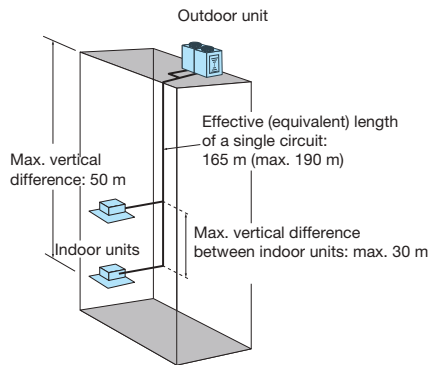

## Series Y ECOSTANDARD TRIPLE (PUHY-P1050-1500YSKA)

### GEOMETRIC LIMITS OF REFRIGERATION PIPELINES

Total effective length	max. 1000 m
Effective length of a single circuit	max. 165 m
Equivalent length of a single circuit	max. 190 m
Effective length after first branch	max. 90 m *1
Effective length between outdoor units	max. 10 m

### VERTICAL DIFFERENCE BETWEEN UNITS

Indoor/outdoor (outdoor unit in higher position)	max. 50 m *2
Indoor/outdoor (indoor unit in higher position)	max. 40 m *3
Indoor/Indoor	max. 30 m *4
Between outdoor units	max. 0,1 m

Indicative values only – See technical handbook for installation details.

\*1 For lengths exceeding 40 m, a larger diameter liquid pipe must be used.

\*2 A max. length of 90 m is possible for certain models and in certain installation conditions. Contact head office for more details.

\*3 A max. length of 60 m is possible for certain models and in certain installation conditions. Contact head office for more details.

\*4 For vertical differences exceeding 15 m, a larger diameter liquid pipe must be used.

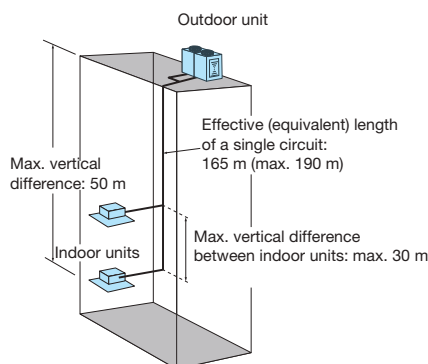

## Series Y STANDARD SINGLE (PUHY-P200-350YKB-A1) optimised for nominal performance

## Series Y STANDARD SINGLE (PUHY-EP200-500YLM-A) optimised for seasonal performance

### GEOMETRIC LIMITS OF REFRIGERATION PIPELINES

Total effective length	max. 1000 m
Effective length of a single circuit	max. 165 m
Equivalent length of a single circuit	max. 190 m
Effective length after first branch	max. 90 m *1

### VERTICAL DIFFERENCE BETWEEN UNITS

Indoor/outdoor (outdoor unit in higher position)	max. 50 m *2
Indoor/outdoor (indoor unit in higher position)	max. 40 m *3
Indoor/Indoor	max. 30 m *4

Indicative values only – See technical handbook for installation details.

\*1 For lengths exceeding 40 m, a larger diameter liquid pipe must be used.

\*2 A max. length of 90 m is possible for certain models and in certain installation conditions. Contact head office for more details.

\*3 A max. length of 60 m is possible for certain models and in certain installation conditions. Contact head office for more details.

\*4 For vertical differences exceeding 15 m, a larger diameter liquid pipe must be used

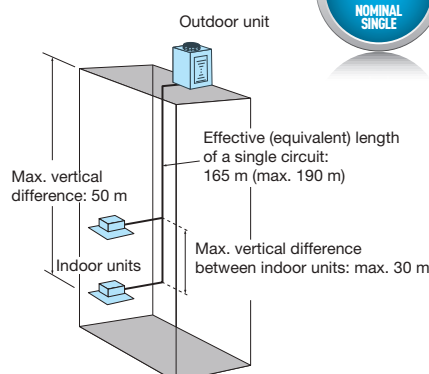

## Series Y DOUBLE (PUHY-P400-900YSKB-A1) optimised for nominal performance

## Series Y DOUBLE (PUHY-EP550-600YSLM-A) optimised for seasonal performance

### GEOMETRIC LIMITS OF REFRIGERATION PIPELINES

Total effective length	max. 1000 m
Effective length of a single circuit	max. 165 m
Equivalent length of a single circuit	max. 190 m
Effective length after first branch	max. 90 m <sup>*1</sup>
Effective length between outdoor units	max. 10 m

### VERTICAL DIFFERENCE BETWEEN UNITS

Indoor/outdoor (outdoor unit in higher position)	max. 50 m <sup>*2</sup>
Indoor/outdoor (indoor unit in higher position)	max. 40 m <sup>*3</sup>
Indoor/Indoor	max. 30 m <sup>*4</sup>
Between outdoor units	max. 0,1 m

Indicative values only – See technical handbook for installation details.

<sup>\*1</sup> For lengths exceeding 40 m, a larger diameter liquid pipe must be used.

<sup>\*2</sup> A max. length of 90 m is possible for certain models and in certain installation conditions. Contact head office for more details.

<sup>\*3</sup> A max. length of 60 m is possible for certain models and in certain installation conditions. Contact head office for more details.

<sup>\*4</sup> For vertical differences exceeding 15 m, a larger diameter liquid pipe must be used.

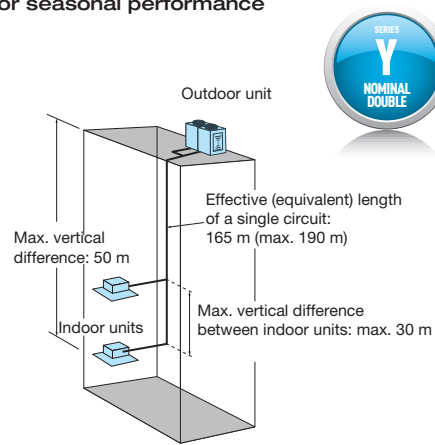

## Series Y TRIPLE (PUHY-P950-1350YSKB-A1) optimised for nominal performance

## Series Y TRIPLE (PUHY-EP650-1350YSLM-A) optimised for seasonal performance

### GEOMETRIC LIMITS OF REFRIGERATION PIPELINES

Total effective length	max. 1000 m
Effective length of a single circuit	max. 165 m
Equivalent length of a single circuit	max. 190 m
Effective length after first branch	max. 90 m <sup>*1</sup>
Effective length between outdoor units	max. 10 m

### VERTICAL DIFFERENCE BETWEEN UNITS

Indoor/outdoor (outdoor unit in higher position)	max. 50 m <sup>*2</sup>
Indoor/outdoor (indoor unit in higher position)	max. 40 m <sup>*3</sup>
Indoor/Indoor	max. 30 m <sup>*4</sup>
Between outdoor units	max. 0,1 m

Indicative values only – See technical handbook for installation details.

<sup>\*1</sup> For lengths exceeding 40 m, a larger diameter liquid pipe must be used.

<sup>\*2</sup> A max. length of 90 m is possible for certain models and in certain installation conditions. Contact head office for more details.

<sup>\*3</sup> A max. length of 60 m is possible for certain models and in certain installation conditions. Contact head office for more details.

<sup>\*4</sup> For vertical differences exceeding 15 m, a larger diameter liquid pipe must be used.

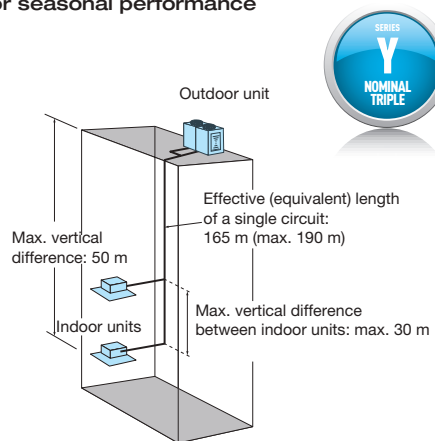

## Series Y ZUBADAN SINGLE (PUHY-HP200,250YHM-A)

### GEOMETRIC LIMITS OF REFRIGERATION PIPELINES

Total effective length	max. 300 m
Effective length of a single circuit	max. 150 m
Equivalent length of a single circuit	max. 175 m
Effective length after first branch	max. 40 m

### VERTICAL DIFFERENCE BETWEEN UNITS

Indoor/outdoor (outdoor unit in higher position)	max. 50 m
Indoor/outdoor (indoor unit in higher position)	max. 40 m
Indoor/Indoor	max. 15 m

Indicative values only – See technical handbook for installation details.

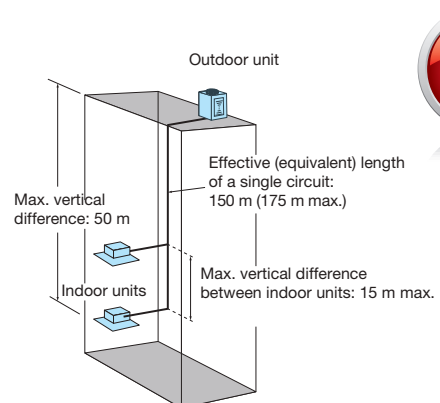

## Series Y ZUBADAN DOUBLE (PUHY-HP400-500YSHM-A)

### GEOMETRIC LIMITS OF REFRIGERATION PIPELINES

Total effective length	max. 300 m
Effective length of a single circuit	max. 150 m
Equivalent length of a single circuit	max. 175 m
Effective length after first branch	max. 40 m
Effective length between outdoor units	max. 10 m

### VERTICAL DIFFERENCE BETWEEN UNITS

Indoor/outdoor (outdoor unit in higher position)	max. 50 m
Indoor/outdoor (indoor unit in higher position)	max. 40 m
Indoor/Indoor	max. 15 m
Between outdoor units	max. 0,1 m

Indicative values only – See technical handbook for installation details.

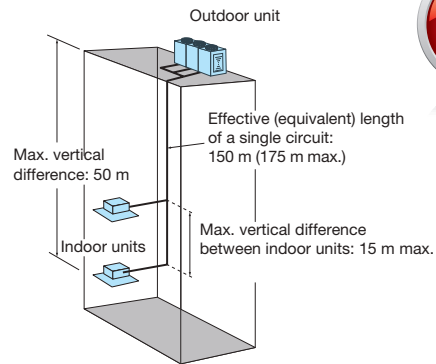

## Series Y Replace Multi (PUHY-RP200~350YJM-B)

### GEOMETRIC LIMITS OF REFRIGERATION PIPELINES

Total effective length	max. 300 m
Effective length of a single circuit	max. 120 m
Equivalent length of a single circuit	max. 150 m
Effective length after first branch	max. 40 m

### VERTICAL DIFFERENCE BETWEEN UNITS

Indoor/outdoor (outdoor unit in higher position)	max. 50 m
Indoor/outdoor (indoor unit in higher position)	max. 40 m
Indoor/Indoor	max. 15 m
Between outdoor units	max. 0,1 m

Indicative values only – See technical handbook for installation details.

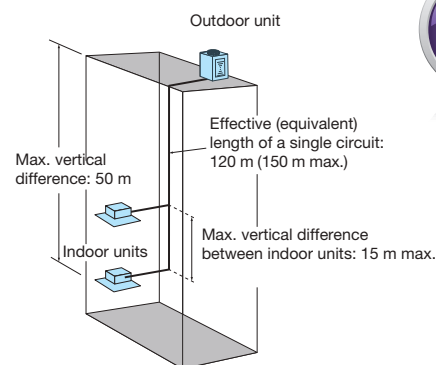

## Series WY SINGLE (PQHY-P200~300YHM-A)

### GEOMETRIC LIMITS OF REFRIGERATION PIPELINES

Total effective length	max. 300 m
Effective length of a single circuit	max. 165 m
Equivalent length of a single circuit	max. 190 m
Effective length after first branch	max. 40 m

### VERTICAL DIFFERENCE BETWEEN UNITS

Indoor/outdoor (outdoor unit in higher position)	max. 50 m
Indoor/outdoor (indoor unit in higher position)	max. 40 m
Indoor/Indoor	max. 15 m

Indicative values only – See technical handbook for installation details.

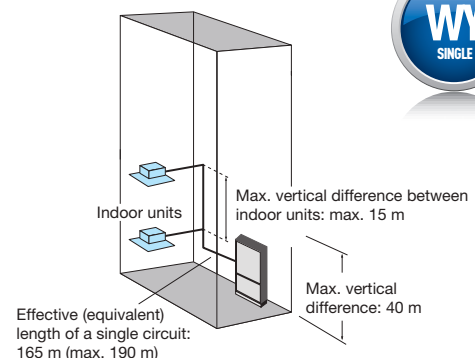

## Series WY DOUBLE (PQHY-P400~900YSHM-A)



### GEOMETRIC LIMITS OF REFRIGERATION PIPELINES

Total effective length	max. 500 m
Effective length of a single circuit	max. 165 m
Equivalent length of a single circuit	max. 190 m
Effective length after first branch	max. 40 m
Effective length between outdoor units	max. 10 m

### VERTICAL DIFFERENCE BETWEEN UNITS

Indoor/outdoor (outdoor unit in higher position)	max. 50 m	*1
Indoor/outdoor (indoor unit in higher position)	max. 40 m	*2
Indoor/Indoor	max. 15 m	
Between outdoor units	max. 0,1 m	

Indicative values only – See technical handbook for installation details.

\*1 A max. length of 90 m is possible for certain models and in certain installation conditions. Contact head office for more details.

\*2 A max. length of 60 m is possible for certain models and in certain installation conditions. Contact head office for more details.

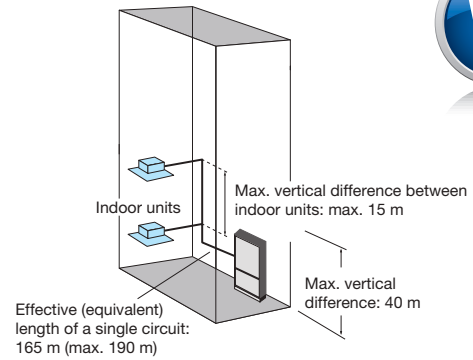

## Series R2 SINGLE (PURY-P200-350YLM-A1) optimised for nominal performance

## Series R2 SINGLE (PURY-EP200-500YLM-A) optimised for seasonal performance



### GEOMETRIC PIPING LIMITATIONS WITH ONE OR MORE BC CONTROLLERS

Total effective length	300~600 m.	*
Effective length of a single circuit	max. 165 m	
Equivalent length of a single circuit	max. 190 m	
Effective length between outdoor unit and BC controller	max. 110 m	
Effective length between BC controller and indoor unit	40~60 m.	*

### VERTICAL DIFFERENCE BETWEEN UNITS

Indoor/outdoor (outdoor unit in higher position)	max. 50 m	*1
Indoor/outdoor (indoor unit in higher position)	max. 40 m	*2
Indoor/BC Controller	max. 15 m (10m)	*3
Indoor/Indoor	max. 15 m (10m)	*3
Effective length between outdoor unit and BC controller	max. 15 m (10m)	*3

BC controllers are connected to each other with three-pipe connections.

\* Indicative values only – See technical handbook for installation details.

\*1 A max. length of 90 m is possible for certain models and in certain installation conditions. Contact head office for more details.

\*2 A max. length of 60 m is possible for certain models and in certain installation conditions. Contact head office for more details.

\*3 Values between brackets ( ) are for P200/P250 indoor units.

P100/250 type indoor units and indoor units of any other type must never be connected to the same branch line.

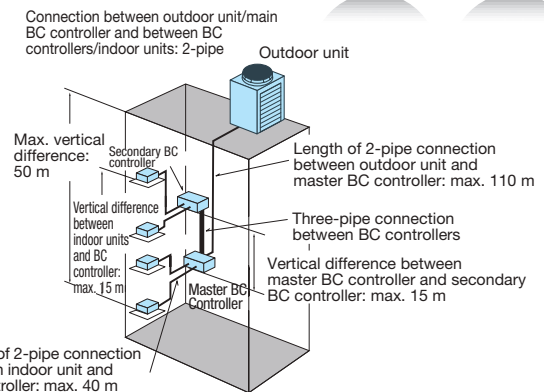

Table of combinations	P 200-250-300-350	P 400-650
CMB-P V-G	✓	✗
CMB-P V-GA	✓	✓
CMB-P V-HA	✗	✗
CMB-P V-GB	✓	✓
CMB-P V-HB	✓	✓

✓ = YES ✗ = NO

**Series R2 DOUBLE (PURY-P400-700YSLM-A) optimised for nominal performance**

**Series R2 DOUBLE (PURY-EP550-900YSLM-A) optimised for seasonal performance**



**GEOMETRIC PIPING LIMITATIONS WITH ONE OR MORE BC CONTROLLERS**

Total effective length	500-950 m.	*
Effective length of a single circuit	max. 165 m	
Equivalent length of a single circuit	max. 190 m	
Effective length between outdoor unit and BC controller	max. 110 m	
Effective length between BC controller and indoor unit	40-60 m.	*
Effective length between outdoor units	max. 15 m	

**VERTICAL DIFFERENCE BETWEEN UNITS**

Indoor/outdoor (outdoor unit in higher position)	max. 50 m	*1
Indoor/outdoor (indoor unit in higher position)	max. 40 m	*2
Indoor/BC Controller	max. 15 m (10m)	*3
Indoor/Indoor	max. 15 m (10m)	*3
Effective length between outdoor unit and BC controller	max. 15 m (10m)	*3
Between outdoor units	max. 0,1 m	

BC controllers are connected to each other with three-pipe connections.

\* Indicative values only – See technical handbook for installation details.

\*1 A max. length of 90 m is possible for certain models and in certain installation conditions. Contact head office for more details.

\*2 A max. length of 60 m is possible for certain models and in certain installation conditions. Contact head office for more details.

\*3 Values between brackets ( ) are for P200/P250 indoor units.

P100/250 type indoor units and indoor units of any other type must never be connected to the same branch line.

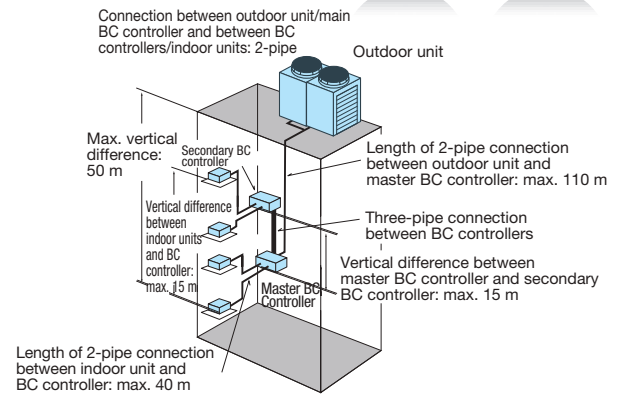

Table of combinations	P 400-650	P 700-800
CMB-P V-G	X	X
CMB-P V-GA	✓	X
CMB-P V-HA	X	✓
CMB-P V-GB	✓	✓
CMB-P V-HB	✓	✓

✓ = YES X = NO

**Series R2 Replace Multi (PURY-RP200~300YJM-B) with one or more BC Controllers**

**GEOMETRIC LIMITS OF REFRIGERATION PIPELINES**

Total effective length	max. 220 m
Effective length of a single circuit	max. 100 (90) m
Equivalent length of a single circuit	max. 125 (115) m
Effective length between outdoor unit and BC controller	max. 70 (60) m
Effective length between BC controller and indoor unit	max. 30 m

**VERTICAL DIFFERENCE BETWEEN UNITS**

Indoor/outdoor (outdoor unit in higher position)	max. 50 m
Indoor/outdoor (indoor unit in higher position)	max. 40 m
Indoor/BC Controller	max. 15 (10) m
Indoor/Indoor	max. 15 (10) m
Effective length between outdoor unit and BC controller	max. 15 (10) m

Values shown in bracket ( ) in the table are applicable if the total capacity of the IUs exceeds 130% of the nominal capacity of the outdoor unit

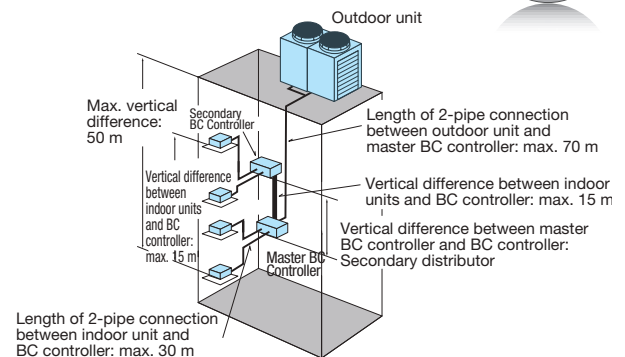

## Series WR2 SINGLE (PQRY-P200~300YHM-A) optimised for nominal performance



### GEOMETRIC PIPING LIMITATIONS WITH ONE OR MORE BC CONTROLLERS

Total effective length	300~550 m.	*
Effective length of a single circuit	max. 165 m	
Equivalent length of a single circuit	max. 190 m	
Effective length between outdoor unit and BC controller	max. 110 m	
Effective length between BC controller and indoor unit	40~60 m.	*

### VERTICAL DIFFERENCE BETWEEN UNITS

Indoor/outdoor (outdoor unit in higher position)	max. 50 m	
Indoor/outdoor (indoor unit in higher position)	max. 40 m	
Indoor/BC Controller	max. 15 m (10m)	*1
Indoor/Indoor	max. 15 m (10m)	*1
Effective length between outdoor unit and BC controller	max. 15 m (10m)	*1

BC controllers are connected to each other with three-pipe connections.

\*1 Values between brackets ( ) are for P200/P250 indoor units.

\* Indicative values only – See technical handbook for installation details.

P100/250 type indoor units and indoor units of any other type must never be connected to the same branch line.

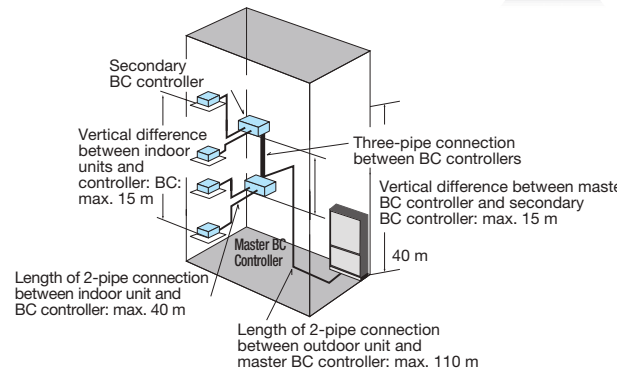

Table of combinations	P 200-250-300-350	P 400-650
CMB-P V-G	✓	✗
CMB-P V-GA	✓	✓
CMB-P V-HA	✗	✗
CMB-P V-GB	✓	✓
CMB-P V-HB	✗	✗

✓ = YES ✗ = NO

## Series WR2 DOUBLE (PQRY-P400~600YSHM-A)



### GEOMETRIC PIPING LIMITATIONS WITH ONE OR MORE BC CONTROLLERS

Total effective length	500~750 m.	*
Effective length of a single circuit	max. 165 m	
Equivalent length of a single circuit	max. 190 m	
Effective length between outdoor unit and BC controller	max. 110 m	
Effective length between BC controller and indoor unit	40~60 m.	*
Effective length between outdoor units	max. 10 m	

### VERTICAL DIFFERENCE BETWEEN UNITS

Indoor/outdoor (outdoor unit in higher position)	max. 50 m	
Indoor/outdoor (indoor unit in higher position)	max. 40 m	
Indoor/BC Controller	max. 15 m (10m)	*1
Indoor/Indoor	max. 15 m (10m)	*1
Effective length between outdoor unit and BC controller	max. 15 m (10m)	*1
Between outdoor units	0.1 m max.	

BC controllers are connected to each other with three-pipe connections.

\*1 Values between brackets ( ) are for P200/P250 indoor units.

\* Indicative values only – See technical handbook for installation details.

P100/250 type indoor units and indoor units of any other type must never be connected to the same branch line.

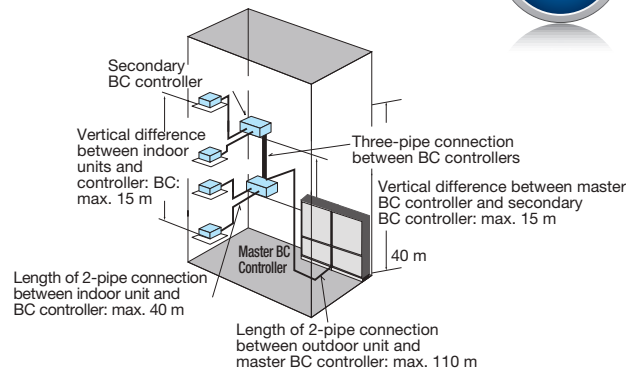
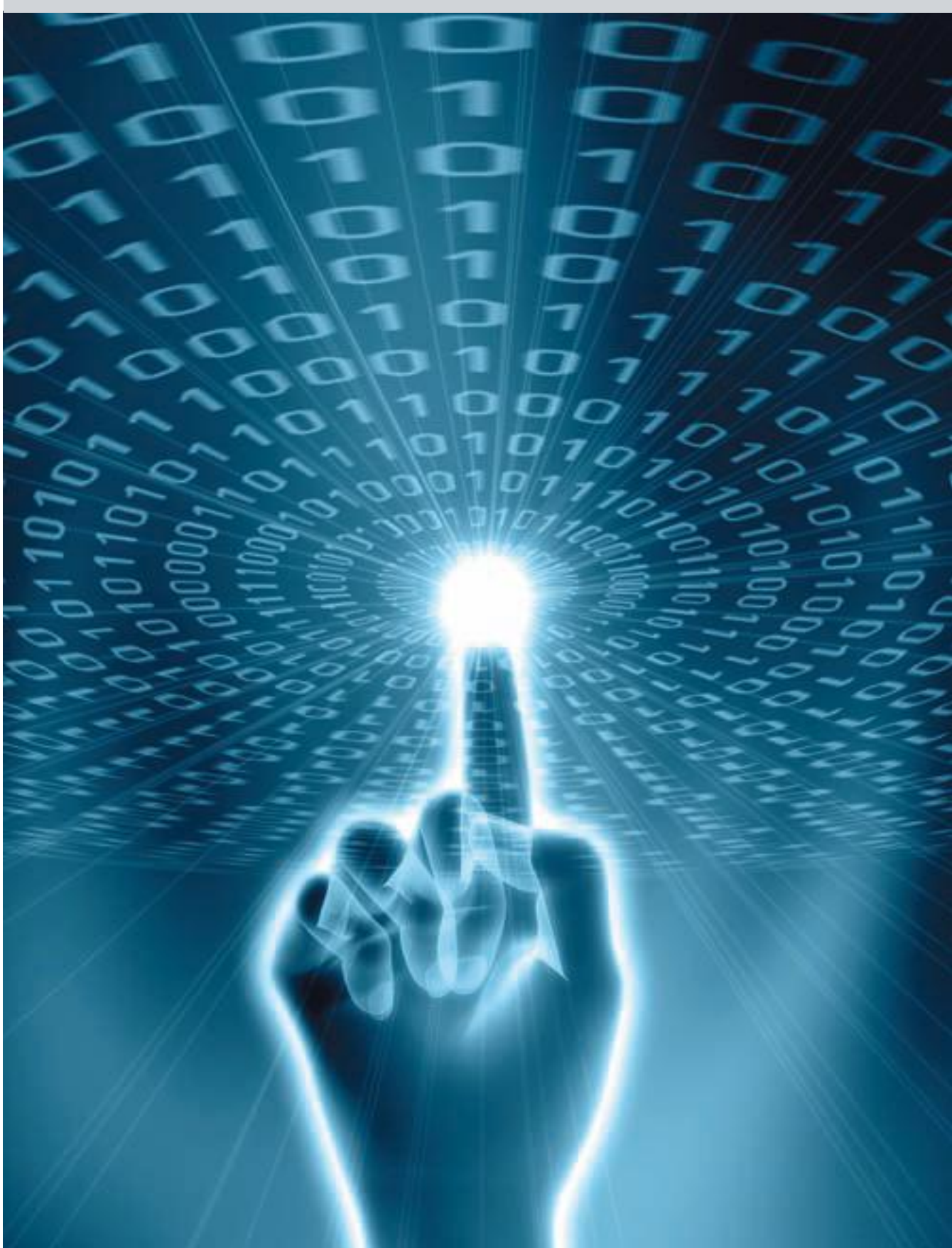

Table of combinations	P 200-250-300-350	P 400-650
CMB-P V-G	✓	✗
CMB-P V-GA	✓	✓
CMB-P V-HA	✗	✗
CMB-P V-GB	✓	✓
CMB-P V-HB	✗	✗

✓ = YES ✗ = NO



# CITY MULTI



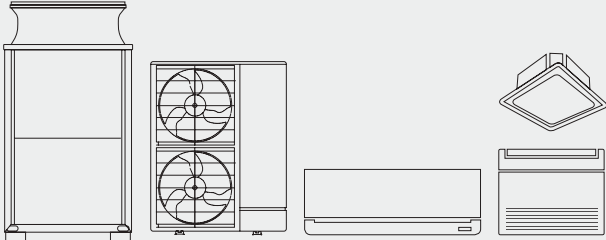





















## Indoor units

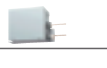



## INDEX

<b>NEW</b>	PLFY-P VFM-E .....	124
	PLFY-P VBM-E .....	126
	PLFY-P VLMD-E .....	128
	PMFY-P VBM-E .....	130
	PEFY-P VMR-E-L .....	132
	PEFY-P VMS1-E .....	134
	PEFY-P VMA-E .....	136
	PEFY-P VMH-E .....	138
	PEFY-P VMHS-E .....	140
	PCFY-P VKM-E .....	142
	PKFY-P VBM-E – PKFY-P VHM-E – PKFY-P VKM-E .....	144
	ALASPLIT® .....	146
	PAC-LV11-E - Wall mounted indoor unit .....	148
<b>NEW</b>	PAC-LV11-E - Floor Standing indoor unit .....	150
	PFFY-P VKM-E .....	152
	PFFY-P VLEM-E .....	154
	PFFY-P VLRM-E – PFFY-P VLRMM-E .....	156
	VRF HP DXE – VRF HP R DXE .....	158

TYPE	MODEL NAME	MODEL	P15	P20	P25	P32	P40		
			1,7 kW*1	2,2 kW*1	2,8 kW*1	3,6 kW*1	4,5 kW*1		
<b>CEILING CASSETTE</b>	4-way flow	PLFY-P-VFM-E 							
		PLFY-P-VBM-E							
	2-way flow	PLFY-P-VLMD-E							
	1-way flow	PMFY-P-VBM-E							
<b>CEILING CONCEALED INDOOR UNITS</b>	Low static pressure	PEFY-P VMR-E-L/R							
	Middle-low static pressure	PEFY-PVMS1(L)-E							
	Middle-high static pressure	PEFY-P VMA(L)-E							
	High static pressure	PEFY-P VMH-E							
	High static pressure	PEFY-P VMHS-E							
<b>CEILING SUSPENDED INDOOR UNITS</b>		PCFY-P VKM-E							
<b>WALL MOUNTED INDOOR UNITS</b>		PKFY-P VBM							
		PKFY-P VHM							
		PKFY-P VKM							
	Wall mounted design with LEV-KIT 	LEV KIT MSZ-EF (KIRIGAMINE ZEN WHITE, BLACK, SILVER)							
		LEV KIT MSZ-SF							
<b>FLOOR STANDING INDOOR UNITS</b>	Floor standing indoor units with LEV-KIT 	LEV KIT WITH MFZ-KJ 							
		PFFY-P VKM-E							
		PFFY-P VLEM-E							
	Concealed type	PFFY-P VLRM-E PFFY-P VLMM-E							
<b>AIR CURTAIN</b>	Exposed type	VRF HP DXE							
	Recessid type	VRF HP R DXE							



## Style



### "PURE WHITE" COLOUR

This is the colour adopted by Mitsubishi Electric for many of its indoor units. It is a colour suitable for virtually all interior spaces.



### AUTOMATIC VANE

The vane adjusts automatically to the optimum angle in relation to operating mode and output air temperature.



### ALASPLIT® COMPATIBLE

The indoor unit may be installed in the Alasplit® concealed built-in mounting system

## Air Quality



### OUTDOOR AIR INTAKE

The air quality in the indoor space may be improved using the outdoor fresh air intake.



### STANDARD FILTER

A honeycomb or synthetic fibre filter with high dust holding capacity.



### LONG-LIFE FILTER

The special surface of the long-life filter requires less maintenance than a conventional filter.



### CATECHIN FILTER

Filter based on a bioflavonoid derived from green tea, which deodorises the indoor space and prevents the propagation of viruses and bacteria.



### "DIRTY FILTERS" INDICATOR SIGNAL

Filter usage is monitored to indicate when maintenance is necessary.



### "NANO PLATINUM" FILTER

Filter with a platinum nano-particle coating with potent oxidant properties. Neutralises viruses, allergens and unpleasant odours.



### ANTI-ALLERGY ENZYME FILTERS

Allergens, spores and bacteria are trapped by the filter and broken down by enzymes in the filter itself.

## Air distribution



### VANE POSITIONS

Number of possible positions for the air deflector vane.



### SWING VANE

A continuous swinging motion of the vane ensures that air is distributed ideally throughout the room.



### FAN SPEED

Number of fan speeds available.



### AUTOMATIC FAN

Fan speed is adjusted automatically to attain the level of comfort required.



### HIGH CEILING

For installations on high ceilings, the air flow may be augmented to improve air distribution.



### LOW CEILING

For installations on low ceilings, the air flow may be reduced to prevent unpleasant draughts.



### AIR INTAKE ON UNDERSIDE

As an option during installation, the unit may be configured with the air intake on the underside.

## Functions



### TIMER

Annual, weekly, daily or simplified timer functions may be used to switch the unit on and off as desired.



### AUTOMATIC MODE SWITCHING

The indoor unit automatically (AUTO) switches operating mode (COOL/HEAT) in relation to the temperature setting.



### REMOTE CONTROL

The indoor unit may be linked to a remote control with a timer, which allows access to numerous functions.



### GROUP CONTROL

Up to 16 indoor units of the same series can be controlled from a single remote control.



### M-NET CONNECTION

The unit may be integrated in an M-NET control system and configured, monitored and supervised from centralised controller units.



### ULTRA-QUIET

These indoor units produce extraordinarily low sound pressure levels.

## Special functions



### AUTO RESTART

In the event of a temporary power loss, the unit automatically restarts when power is restored (this function must be enabled for all indoor units during initial configuration and is disabled by default).



### LOW TEMPERATURE COOLING

Where the ability to cool to lower temperatures is necessary, the settable temperature range in cooling mode may be extended to offer a lowest temperature of 14°C.



### AIR STRATIFICATION COMPENSATION

To compensate for air stratification phenomena, in HEAT mode, the inlet air temperature reading is adjusted by an offset of -4°C (function enabled by default, and must be disabled, if required, during initial configuration).

## Installation and Maintenance



### CONDENSATE DRAIN PUMP

The condensate drain pump facilitates installation.



### SELF-DIAGNOSTICS

A self-diagnostic system makes troubleshooting and correcting malfunctions easier by recording a log of faults.

# Special functions

## Auto Restart



The auto restart function may be used to configure the indoor units to restart automatically after a power outage, minimising interruptions in the operation of the system to maintain thermal comfort levels in the air conditioned spaces.

This function must be enabled as an option as it is not enabled by default. A choice of two automatic start configurations is available:

- restart only the indoor units which were on before the power outage;
- restart all indoor units, irrespective of on/off state before the power outage.

## Low Temperature Cooling



This function extends the operating temperature range in cooling mode to offer a lowest settable temperature of 14°C. Where the ability to cool to temperatures lower than the standard lowest comfort value of 19°C (typically for sports centres, laboratories etc.) is necessary, the settable temperature range in cooling mode may be extended to offer a lowest temperature of 14°C on the following models:

This function may be enabled during installation and is available on the following models:

- PLFY-P VLMD - 2-way cassette
- PEFY-P VMR - Ducted
- PEFY-P VMS1(L) - Ducted
- PEFY-P VMAL - Ducted
- PEFY-P VMH - Ducted
- PEFY-P VMHS - Ducted
- PFFY-P VLEM - Floor-standing
- PFFY-P VLRM - Built-in floor unit
- PFFY-P VLRMM - Built-in floor unit

The indoor unit fan is run at a higher speed in this configuration (except with the SMALL Y model outdoor unit of the PUMY series).



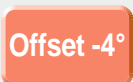



































## Stratification compensation



The automatic heat stratification compensation function in HEAT mode is implemented by adjusting the ambient temperature read by a probe on the indoor unit, to obtain a value that more closely reflects the true temperature of the air conditioned space.

An offset of -4°C is applied, so that, for instance, if the inlet temperature measured is 24°C, the system automatically displays an adjusted value of 20°C, which should more closely reflect the true ambient temperature. The Mitsubishi Electric CITY MULTI VRF system bases the thermal power actually delivered on this value.

The stratification compensation function is available on all Mitsubishi Electric indoor unit types with the exception of floor-standing units and certain specific cases (such as with units with underside air intakes), and may be disabled on request.

		CASSETTE				DUCTED					CEILING
											
		NEW									
		PLFY-P VFM-E	PLFY-P VBM-E	PLFY-P VLMD-E	PMFY-P VBM-E	PEFY-P VMR-E-L/R	PEFY-P VMS1-E	PEFY-P VMA-E	PEFY-P VMH-E	PEFY-P VMHS-E	PCFY-P VKM-E
DESIGN		✓	✓	✓	✓						✓
		✓	✓	✓	✓						✓
											
AIR QUALITY		✓	✓	✓							✓
			✓		✓						
		✓		✓							✓
		✓	✓	✓	✓						✓
											
											
		5	5	4	4						5
AIR DISTRIBUTION		✓	✓	✓	✓						✓
		3	4	3 3 (P125)	4	3	3	3	2	3	4
			✓				✓			✓	✓
			✓								✓
			✓								✓
						✓		✓			
											
FUNCTIONS		✓	✓		✓	✓	✓	✓	✓	✓	✓
		✓	✓	✓	✓	✓	✓	✓	✓	✓	✓
		✓	✓	✓	✓	✓	✓	✓	✓	✓	✓
				✓		✓	✓	✓	✓	✓	
		✓	✓	✓	✓	✓	✓	✓	✓	✓	✓
		✓	✓	✓	✓	✓	✓	✓	✓	✓	✓
		✓	✓	✓	✓	✓	✓	✓	✓	✓	✓
				✓		✓	✓				
		✓	✓		✓	✓	✓	✓	✓	✓	✓
		✓	✓		✓	✓	✓	✓	✓	✓	✓
FUNCTIONS MAINTENANCE		✓	✓	✓	✓		✓*		✓*	✓*	
		✓	✓	✓	✓	✓	✓	✓	✓	✓	✓

\* Available also without pump (VMS1L) (VMAL).

	WALL MOUNTED					FLOOR STANDING					AIR CURTAIN	
	PKFY-P VBM-E	PKFY-P VHM-E	PKFY-P VKM-E	LEV KIT MSZ-EF	LEV KIT MSZ-SF	LEV KIT MFZ-KJ	PFFY-P VKM-E	PFFY-P VLEM-E	PFFY-P VLRM-E	PFFY-P VLRMM-E	VRF HP DXE	VRF HP R DXE
	✓	✓	✓		✓	✓	✓					
	✓	✓	✓	✓	✓	✓	✓					
	✓				✓							
	✓	✓	✓					✓	✓	✓	✓	✓
							✓					
	✓	✓	✓				✓	✓	✓	✓	✓	✓
				✓	✓	✓						
				✓	✓	✓						
	4	5	4	5	5	4	4					
		✓	✓	✓	✓	✓	✓					
	4	3	2	5	5	5	4	2	2	3	3	3
		✓		✓	✓	✓				✓		
	✓	✓	✓	✓	✓	✓	✓	✓	✓	✓	✓	✓
	✓	✓	✓	✓	✓	✓	✓	✓	✓	✓	✓	✓
	✓	✓	✓	✓	✓	✓	✓	✓	✓	✓	✓	✓
						✓		✓	✓	✓		
	✓	✓	✓	✓	✓	✓	✓	✓	✓	✓	✓	✓
	✓	✓	✓	✓	✓	✓	✓	✓	✓	✓	✓	✓
	✓	✓	✓	✓	✓	✓	✓	✓	✓	✓	✓	✓
					✓							
	✓	✓	✓									
	✓	✓	✓	✓	✓	✓	✓	✓	✓	✓	✓	✓

# CITY MULTI PLFY-P VFM-E

NEW

INDOOR UNIT - 4-WAY CASSETTE



The straight-line shape introduced has resulted in a stylish and modern square design. Its high affinity ensures the ability to blend in seamlessly with any interior. The indoor unit is an ideal match for office or store use.

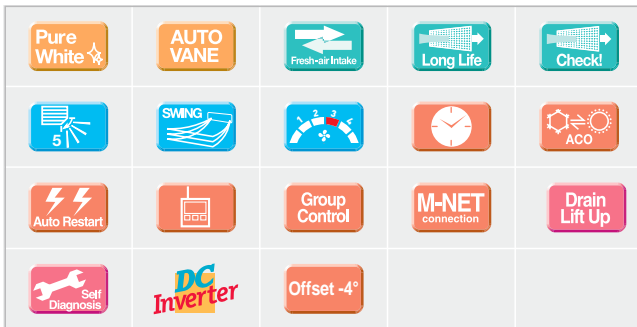
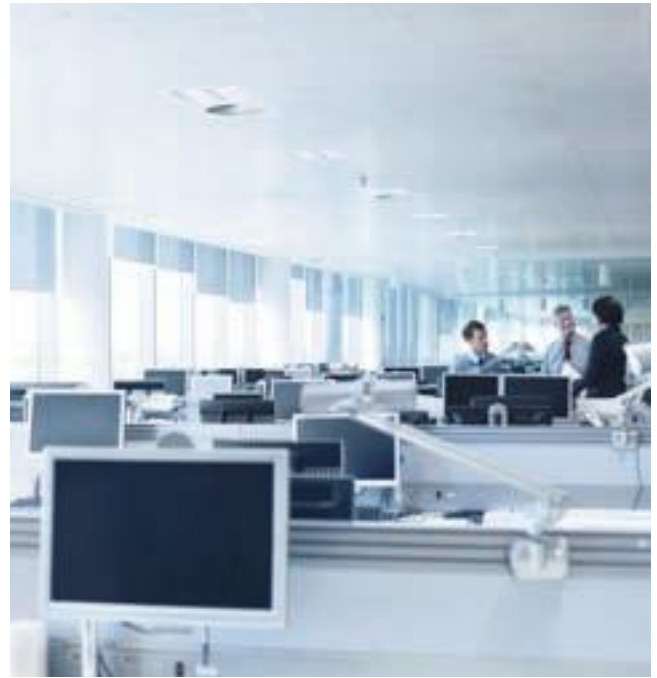

## Simplified installation

The height above ceiling of 245 mm is top class in the industry. The height above ceiling of 245 mm enables fitting into narrow ceiling space. Installation is simple, even when the ceiling spaces are narrow to make the ceilings higher.

Light weight (max 15kg) and temporary hanging hooks for grille allow to make installation easier and quicker.

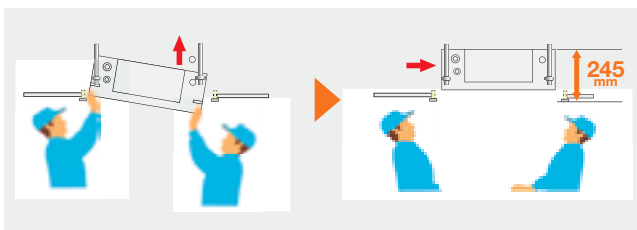

## Superior air flow control

The new airflow control completely eliminates that uncomfortable drafty-feeling with the introduction of a **horizontal airflow** that spreads across the ceiling, maximizing the Coanda effect. Furthermore, 5 patterns for vane position (on previous VCM was 4) and individual settable vane and ways ensure higher comfort. The ideal airflow for offices and restaurants.

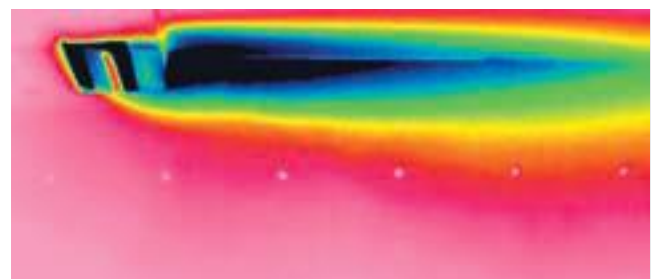



### 3D i-see Sensor

New advanced 3D i-see sensor detects people's position and number. Once a person is detected, the angle of the vane is automatically adjusted. Each vane can be independently set to "Direct Airflow" or "Indirect Airflow" according to taste. The 3D i-see Sensor detects the number of people in the room and adjusts the power accordingly. This makes automatic power-saving operation possible in places where the number of people changes frequently.



Additionally, when the area is continuously unoccupied, the system switches to a more enhanced power-saving mode. Depending on the setting, it can also stop the operation.

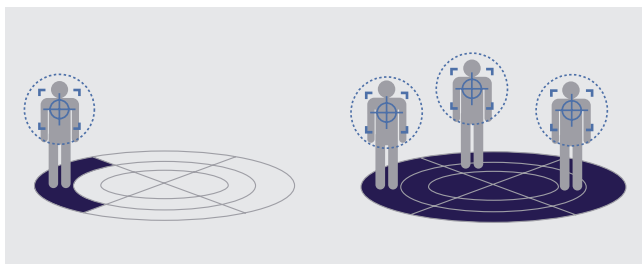

### New size 5kW (P50)

New model has been introduced to expand line-up.

MODEL	1.5 kW	2.0 kW	2.5 kW	3.2 kW	4.0 kW	5.0 kW
PLFY-P VCM	✓	✓	✓	✓	✓	
			↓			
PLFY-P VFM <span style="color: red; font-weight: bold; border: 1px solid red; border-radius: 50%; padding: 2px;">NEW</span>	✓	✓	✓	✓	✓	✓

### Quietness

By the means of a new 3D Turbo Fan and DC inverter motor, sound level has been reduced by 2-4dB(A) for quieter and more comfortable air conditioning.

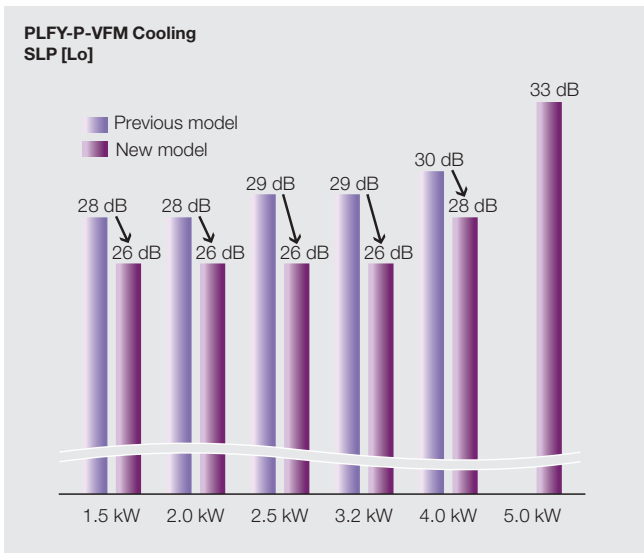

### TECHNICAL SPECIFICATIONS

MODEL		PLFY-P15VFM-E	PLFY-P20VFM-E	PLFY-P25VFM-E	PLFY-P32VFM-E	PLFY-P40VFM-E	PLFY-P50VFM-E
<b>Power</b>		Single phase, 220-240VAC 50Hz					
<b>Capacity in cooling mode*1</b>	kW	1,7	2,2	2,8	3,6	4,5	5,6
	Btu/h	5800	7500	9600	12300	15400	19100
<b>Capacity in heating mode*1</b>	kW	1,9	2,5	3,2	4	5	6,3
	Btu/h	6500	8500	10900	13600	17100	21500
<b>Power consumption</b>	Cooling kW	0,02	0,02	0,02	0,02	0,03	0,04
	Heating kW	0,02	0,02	0,02	0,02	0,03	0,04
<b>Current</b>	Cooling A	0,19	0,21	0,22	0,23	0,28	0,4
	Heating A	0,19	0,21	0,22	0,23	0,28	0,4
<b>External finish</b>	Unit	Galvanised steel sheet with uncoated thermal insulation					
	Grille	Pure White					
<b>Dimensions (HxLxW)</b>	Unit mm	245x570x570					
	Grille mm	10x625x625					
<b>Net weight</b>	Unit kg	14			15		
	Grille kg	3					
<b>Heat exchanger</b>		Cross fins					
<b>Fan</b>	Type x Quantity	3D Turbo fan x 1					
	Air flow*2 m³/min	6,5 - 7,5 - 8	6,5 - 7,5 - 8,5	6,5 - 8 - 9	7 - 8 - 9,5	7,5 - 9 - 11	9 - 11 - 13
	Ext. Static pressure Pa	0					
<b>Air filter</b>		Polypropylen honeycomb (long life)					
<b>Refrigerant pipe diameter</b>	Gas (swaged) mm	12,7					
	Liquid (swaged) mm	6,35					
<b>Sound pressure**3</b>	dB(A)	26 - 28 - 30	26 - 29 - 31	26 - 30 - 33	26 - 30 - 34	28 - 33 - 39	33 - 39 - 43

\*1 For heating/cooling capacity, the maximum value with the unit operating in the following conditions is given.

Cooling: indoor 27°C (81°F) DB/19°C (66°F) WB, outdoor 35°C (95°F) DB. Heating: indoor 20°C (68°F) DB, outdoor 7°C (45°F) DB/6°C (43°F) WB.

\*2 Air flow/noise levels given for operation in low-medium-high modes.

\*3 Measured in anechoic chamber with 230V mains power.

# CITY MULTI PLFY-P VBM-E

INDOOR UNIT - 4-WAY CASSETTE



The VBM 4-way cassette model offers 72 different selectable air flow configurations and is the **ideal solution** for applications with high ceilings up to 4.2 m.

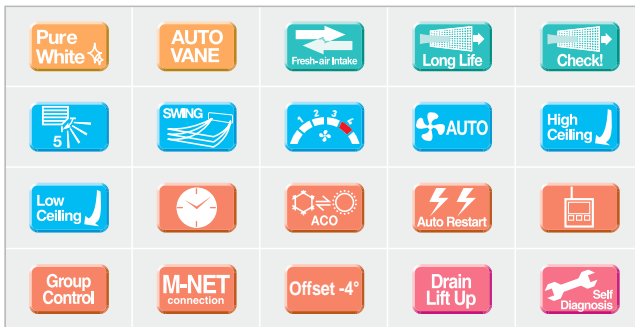

## Wide air flow

### Individually settable vanes

The ability to set the optimum position for each air distribution vane ensures superlative comfort throughout the whole room.

As well as offering different air flow delivery modes (2, 3 or 4-way), this function also makes it possible to select the vertical air flow independently for each vane, to maintain a comfortable and uniformly distributed ambient temperature.

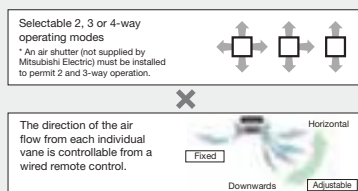

72 settable air flows

### Air flow distributed over a wide area

The wide-angle outlet vents distribute air effectively into every corner of the room.

The outlet vents are larger than on previous models, while the shape of the vents has been optimised to improve ventilation over a broader area.



Illustration of multi-directional air-conditioning



Individually settable vanes + Wide Airflow

The ability to set each single air vane to achieve the ideal air flow for the layout of the individual room, combined with the wide angle outlet air flow function, ensures uniform temperature distribution in every room. The result is homogeneous, comfortable air conditioning.

## Draught-free air distribution

The innovative new horizontal stream mode distributes air horizontally without directing cooled/heated air directly onto the persons in the air conditioned space, avoiding the perceived sense of discomfort caused by overexposure to the air flow.

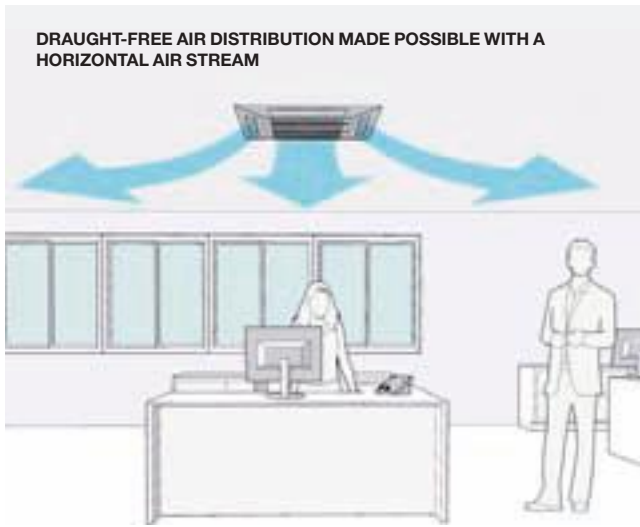

## Automatic fan speed adjustment

The automatic fan speed adjustment mode ensures fast, comfortable heating as soon as heating mode is activated. Automatic fan speed control is included in the four standard modes "Low", "Medium1", "Medium2" and "High", and ensures faster, comfortable air conditioning by increasing the air flow speed on activation and then reducing speed once stable comfort levels are attained.



## Condensate drain pump

The VBM series features a built-in condensate drain pump.

## TECHNICAL SPECIFICATIONS

MODEL		PLFY-P20VBM-E	PLFY-P25VBM-E	PLFY-P32VBM-E	PLFY-P40VBM-E	PLFY-P50VBM-E	PLFY-P63VBM-E	PLFY-P80VBM-E	PLFY-P100VBM-E	PLFY-P125VBM-E	
<b>Power</b>		A single phase, 220-240V 50Hz / a single phase, 200V 60Hz									
<b>Capacity in cooling mode*1</b>	kW	2,2	2,8	3,6	4,5	5,6	7,1	9,0	11,2	14,0	
	Btu/h	7500	9600	12,300	15,400	19,100	24,200	30,700	38,200	47,800	
<b>Capacity in heating mode*1</b>	kW	2,5	3,2	4,0	5,0	6,3	8,0	10,0	12,5	16,0	
	Btu/h	8500	10900	13,600	17,100	21,500	27,300	34,100	42,700	54,600	
<b>Power consumption</b>	Cooling kW	0,03	0,03	0,03	0,04	0,04	0,05	0,07	0,15	0,16	
	Heating kW	0,02	0,02	0,02	0,03	0,03	0,04	0,06	0,14	0,15	
<b>Current</b>	Cooling A	0,26	0,26	0,22	0,29	0,29	0,36	0,51	1,00	1,07	
	Heating A	0,19	0,19	0,14	0,22	0,22	0,29	0,43	0,94	1,00	
<b>External finish (Munsel No.)</b>	Unit	Galvanised steel sheet									
	Grille	White (6.4Y 8.9/0.4)									
<b>Dimensions (HxLxW)</b>	Unit mm	258x840x840						298x840x840			
	Grille mm	35x950x950									
<b>Net weight</b>	Unit kg	22			23		27				
	Grille kg	6									
<b>Heat exchanger</b>		Cross fins (sheet aluminium fins and copper piping)									
<b>Fan</b>	Type x Quantity	Turbo fan x 1									
	Air flow*2	m³/min	12.5-12-11.5-11	11-12-13-14	12-13-14-16	14-15-16-18	16-18-20-22	21-24-27-29	22-25-28-30		
		l/s	208-200-192-183	183-200-217-233	200-217-233-267	233-250-267-300	267-300-333-367	350-400-450-483	367-417-467-500		
	cfm	441-424-406-388	388-424-459-494	424-459-494-565	494-530-565-636	565-636-706-777	742-848-953-1024	777-883-989-1059			
Static ext.l pressure	Pa	0									
<b>Motor</b>	Type	DC motor									
	Power output kW	0.050						0.120			
<b>Air filter</b>		Polypropylene honeycomb									
<b>Refrigerant pipe diameter</b>	Gas (swaged) mm	ø12.7				ø12.7 / ø15.88 (Compatible)		ø15.88		ø15.88 / ø19.05 (Compatible)	
	Liquid (swaged) mm	ø6.35				ø6.35 / ø9.52 (Compatible)		ø9.52 (ø3/8)			
<b>Local drain pipe diameter</b>		O.D 32(1-1/4)-<VP-25>									
<b>Sound pressure**2,3</b>	dB(A)	30-29-28-27	27-28-29-31	27-28-30-31	28-29-30-32	30-32-35-37	34-37-39-41	35-38-41-43			

\*1 For heating/cooling capacity, the maximum value with the unit operating in the following conditions is given.

Cooling: indoor 27°C (81°F) DB/19°C (66°F) WB, outdoor 35°C (95°F) DB. Heating: indoor 20°C (68°F) DB, outdoor 7°C (45°F) DB/6°C (43°F) WB.

\*2 Air flow/noise levels given for operation in low-medium1-medium2-high modes.

\*3 Measured in anechoic chamber with 230V mains power.

# CITY MULTI PLFY-P VLMD-E

INDOOR UNIT - 2-WAY CASSETTE



The slimline design of this unit – which measures **just 290 mm** in height – makes it the ideal solution for installations with limited ceiling space and for replacing obsolete units in old buildings.

Pure White	AUTO VANE	Fresh-air Intake	Long Life	Check!
4-way	SWING	2 3 4	ACO	
Auto Restart	Low Temp Cooling		Group Control	M-NET connection
Offset -4°	Drain Lift Up	Self Diagnosis		

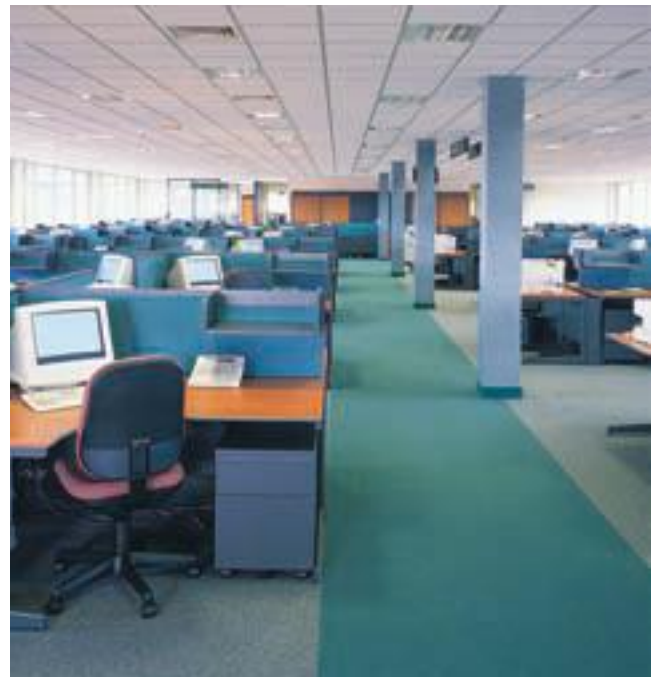

## General characteristics

### Terminal board

The terminal board is located on the exterior of the main unit to make wiring connections easier.

### Direct inlet for external air

Pure fresh air may be fed directly into the main unit (requires optional accessories).

### Long-life filter fitted as standard

The long-life antibacterial filter requires no maintenance whatsoever for intervals of approximately one year.

### Compact unit with low noise levels

Noise levels at 15 Pa (standard static pressure).

		dB(A)									
NOISE LEVEL	Capacity	P20	P25	P32	P40	P50	P63	P80	P100	P125	
	Fan Speed	High		33		36	37	39	39	42	46
		Medium		30		33	34	37	36	39	42/44
		Low		27		29	31	32	33	36	40

## Condensate lift pump

The standard version is equipped with a condensate lift pump mechanism. This allows the drain outlet to be situated up to 583 mm from the level of the ceiling, allowing for greater freedom of movement with longer transverse sections of piping, and greater flexibility in the layout of the piping itself.

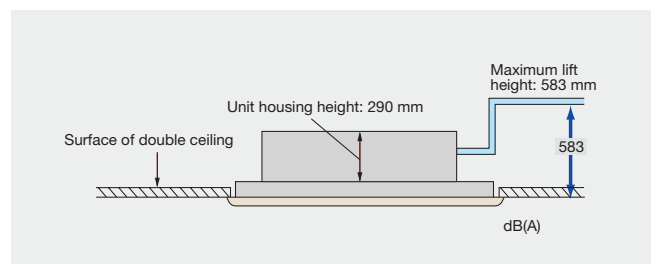

## Easier installation

The possibility of using a lighter panel and of placing the electrical board near the panel make installation and maintenance simpler. Moreover, the heat exchanger can be washed easily by simply moving the central panel, filter and fan.

## TECHNICAL SPECIFICATIONS

MODEL			PLFY-P20VLMD-E	PLFY-P25VLMD-E	PLFY-P32VLMD-E	PLFY-P40VLMD-E	
<b>Power</b>			A single phase, 220-240V 50Hz / a single phase, 220-230V 60Hz				
<b>Capacity in cooling mode*1</b>	kW		2.2	2.8	3.6	4.5	
	Btu/h		7,500	9,600	12,300	15,400	
<b>Capacity in heating mode*1</b>	kW		2.5	3.2	4.0	5.0	
	Btu/h		8,500	10,900	13,600	17,100	
<b>Power consumption</b>	Cooling	kW	0.072 / 0.075	0.072 / 0.075	0.072 / 0.075	0.081 / 0.085	
	Heating	kW	0.065 / 0.069	0.065 / 0.069	0.065 / 0.069	0.074 / 0.079	
<b>Current</b>	Cooling	A	0.36 / 0.37	0.36 / 0.37	0.36 / 0.37	0.40 / 0.42	
	Heating	A	0.30 / 0.32	0.30 / 0.32	0.30 / 0.32	0.34 / 0.37	
<b>External finish (Munsel No.)</b>	Unit		Galvanised steel sheet				
	Grille		White (0.7Y 8.59/0.97)				
<b>Dimensions (HxLxW)</b>	Unit	mm	290x776x634				
	Grille	mm	20x1080x710				
<b>Net weight</b>	Unit	kg	23		24		
	Grille	kg	6.5				
<b>Heat exchanger</b>			Cross fin				
<b>Fan</b>	Type x Quantity		Turbo fan x 1				
	Air flow*2	m <sup>3</sup> /min	6.5-8.0-9.5			7.0-8.5-10.5	
		l/s	108-133-158			117-142-175	
		cfm	230-283-335			247-300-371	
	Static ext.l pressure	Pa	0				
<b>Motor</b>	Type		DC motor				
	Power output	kW	0.015 (at 240V)				
<b>Air filter</b>			Polypropylene honeycomb (long life)				
<b>Refrigerant pipe diameter</b>	Gas (swaged)	mm	ø12.7				
	Liquid (swaged)	mm	ø6.35				
<b>Local drain pipe diameter</b>			O.D.32				
<b>Sound pressure**2*3</b>	220V, 240V	dB(A)	27-30-33			29-33-36	
	230V	dB(A)	28-31-34			30-34-37	

## TECHNICAL SPECIFICATIONS

MODEL			PLFY-P50VLMD-E	PLFY-P63VLMD-E	PLFY-P80VLMD-E	PLFY-P100VLMD-E	PLFY-P125VLMD-E		
<b>Power</b>			A single phase, 220-240V 50Hz / a single phase, 220-230V 60Hz						
<b>Capacity in cooling mode*1</b>	kW		5.6	7.1	9.0	4.5	14.0		
	Btu/h		19,100	24,200	30,700	15,400	47,800		
<b>Capacity in heating mode*1</b>	kW		6.3	8.0	10.0	5.0	16.0		
	Btu/h		21,500	27,300	34,100	17,100	54,600		
<b>Power consumption</b>	Cooling	kW	0.082 / 0.086	0.101 / 0.105	0.147 / 0.156	0.081 / 0.085	0.28 / 0.28		
	Heating	kW	0.075 / 0.080	0.094 / 0.099	0.140 / 0.150	0.074 / 0.079	0.27 / 0.27		
<b>Current</b>	Cooling	A	0.41 / 0.43	0.49 / 0.51	0.72 / 0.74	0.40 / 0.42	1.35 / 1.35		
	Heating	A	0.35 / 0.38	0.43 / 0.46	0.66 / 0.69	0.34 / 0.37	1.33 / 1.33		
<b>External finish (Munsel No.)</b>	Unit		Galvanised steel sheet						
	Grille		White (0.7Y 8.59/0.97)						
<b>Dimensions (HxLxW)</b>	Unit	mm	290x946x634		290x1446x634		290x1708x606		
	Grille	mm	20x1250x710		20x1750x710		20x2010x710		
<b>Net weight</b>	Unit	kg	23	28	44	47	56		
	Grille	kg	7.5		12.5		13.0		
<b>Heat exchanger</b>			Cross fin						
<b>Fan</b>	Type x Quantity		Turbo fan x 1		Turbo fan x 2		Scirocco fan x 4		
	Air flow*2	m <sup>3</sup> /min	6.5-8.0-9.5		11.0-13.0-15.5		15.5-18.5-22.0	17.5-21.0-25.0	24.0-27.0-30.0-33.0
		l/s	108-133-158		167-217-258		258-308-367	292-350-417	400-450-500-550
		cfm	230-283-335		353-459-547		547-653-777	618-742-883	848-953-1,059-1,165
	Static ext.l pressure	Pa	0						
<b>Motor</b>	Type		Single-phase induction motor						
	Power output	kW	0.020 (a 240V)		0.020 (a 240V)	0.030 (a 240V)	0.078x2 (a 240V)		
<b>Air filter</b>			Polypropylene honeycomb (long life)				Synthetic fiber unwoven cloth filter (long life)		
<b>Refrigerant pipe diameter</b>	Gas (swaged)	mm	ø12.7		ø15.88				
	Liquid (swaged)	mm	ø6.35		ø9.52				
<b>Local drain pipe diameter</b>			O.D.32 (1-1/4)						
<b>Sound pressure**2*3</b>	220V, 240V	dB(A)	31-34-37	32-37-39	33-36-39	36-39-42	40-42-44-46		
	230V	dB(A)	32-35-38	33-38-40	34-37-40	37-41-43	40-42-44-46		

\*1 For heating/cooling capacity, the maximum value with the unit operating in the following conditions is given.

Cooling: indoor 27°C (81°F) DB/19°C (66°F) WB, outdoor 35°C (95°F) DB. Heating: indoor 20°C (68°F) DB, outdoor 7°C (45°F) DB/6°C (43°F) WB.

\*2 Air flow/noise levels given for operation in low-medium1-medium2-high modes.

\*3 Measured in anechoic chamber with 230V mains power.

# CITY MULTI PMFY-P VBM-E

INDOOR UNIT - 1-WAY CASSETTE



**Compact, lightweight** design ideal for applications in rooms with limited ceiling space.

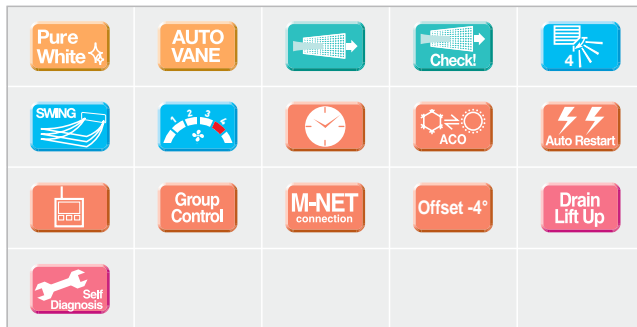

## Easier installation and maintenance

All models share the same standard size of 854 mm for facilitated installation. With the main unit weighing just 14 kg and the panel just 3 kg, this is one of the lightest units available on the market today.

## Condensate lift pump

The condensate drain outlet may be situated anywhere up to 600 mm from the level of the ceiling.

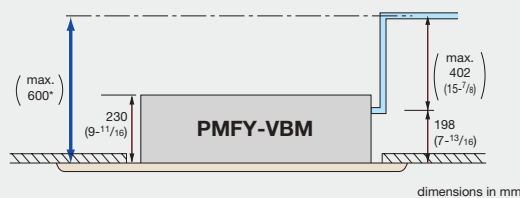

## Quiet operation

New air flow control technology reduces noise levels to just 27dB (P20VBM), making these among the quietest units in their class.

## Improved Coanda effect

This effect gives the air flow a specific trajectory which contributes to creating more uniform circulation in the air conditioned room.

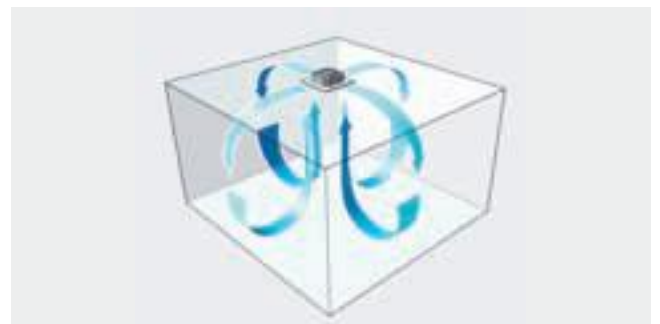

## TECHNICAL SPECIFICATIONS

MODEL		PMFY-P20VBM-E	PMFY-P25VBM-E	PMFY-P32VBM-E	PMFY-P40VBM-E
<b>Power</b>		A single-phase, 220-240V 50Hz / a single-phase, 220-230V 60Hz			
<b>Capacity in cooling mode</b> *1	kW	2.2	2.8	3.6	4.5
	Btu/h	7,500	9,600	12,300	15,400
<b>Capacity in heating mode</b> *1	kW	2.5	3.2	4.0	5.0
	Btu/h	8,500	10,900	13,600	17,100
<b>Power consumption</b>	Cooling	kW	0.044		0.054
	Heating	kW	0.044		0.054
<b>Current</b>	Cooling	A	0.21		0.26
	Heating	A	0.21		0.26
<b>External finish (Munsell No.)</b>	Unit	Galvanised steel sheet			
	Grille	Panel (0.98Y 8.99/0.63)			
<b>Dimensions (HxLxW)</b>	Unit	mm			
	Grille	mm			
<b>Net weight</b>	Unit	kg			
	Grille	kg			
<b>Heat exchanger</b>		Cross fins (sheet aluminium fins and copper piping)			
<b>Fan</b>	Type x Quantity	Linear flow fan x 1			
	Air flow*2	m <sup>3</sup> /min	6.5-7.2-8.0-8.7	7.3-8.0-8.6-9.3	7.7-8.7-9.7-10.7
		l/s	108-120-133-145	122-133-143-155	128-145-162-178
		cfm	230-254-283-307	258-283-304-328	272-307-343-378
	Static ext.l pressure	Pa	0		
<b>Motor</b>	Type	Single-phase induction motor			
	Power output	kW	0.028		
<b>Air filter</b>		Polypropylene honeycomb fabric			
<b>Refrigerant pipe diameter</b>	Gas (swaged)	mm	ø12.7		
	Liquid (swaged)	mm	ø6.35		
<b>Local drain pipe diameter</b>		I.D. 26 <VP-20>			
<b>Sound pressure</b> *2*3	dB(A)	27-30-33-35	32-34-36-37	33-35-37-39	

\*1 For heating/cooling capacity, the maximum value with the unit operating in the following conditions is given.

Cooling: indoor 27°C (81°F) DB/19°C (66°F) WB, outdoor 35°C (95°F) DB. Heating: indoor 20°C (68°F) DB, outdoor 7°C (45°F) DB/6°C (43°F) WB.

\*2 Air flow/noise levels given for operation in low-medium1-medium2-high modes.

\*3 Measured in anechoic chamber with 230V mains power.

# CITY MULTI PEFY-P VMR-E-L

INDOOR UNIT - BUILT-IN FOR DOUBLE CEILINGS  
LOW STATIC PRESSURE



Offers the perfect solution to the specific needs of hotels, museums, libraries and hospitals, where **quietness** is an indispensable requisite.

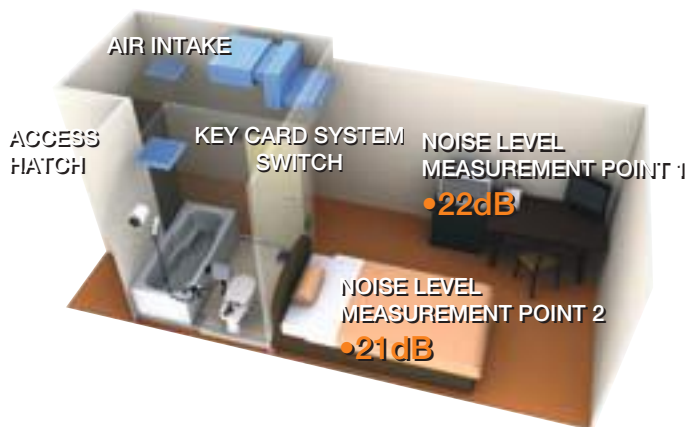
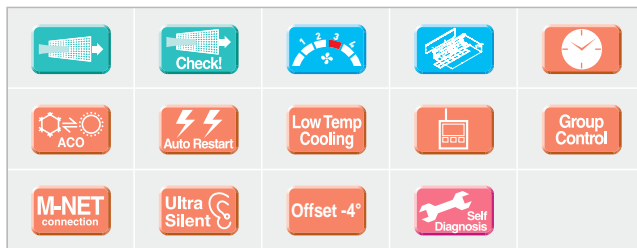

## Simplified maintenance

The condensate collection tray and heat exchangers may be cleaned via an access hatch in the utility space. This makes maintenance both simpler and less expensive.

## Ultra-low noise

These units may be used to achieve a silent environment, with 21dB in the area near the bed and 22dB in the area near the desk.

\*Noise levels may vary depending on the dimensions of the room and the settings of the unit itself.

## Key card system activation

The unit may be switched on and off by inserting a key card.

## Energy savings

The centralised system offers significant savings by preventing units from operating continuously in unoccupied rooms.

**Note:** Each room may also be furnished with simplified, compact controllers, with only on/off and fan speed and temperature setting functions, to let the occupants of each room create their own ideal comfort conditions.



## Installation layouts for different applications and locations

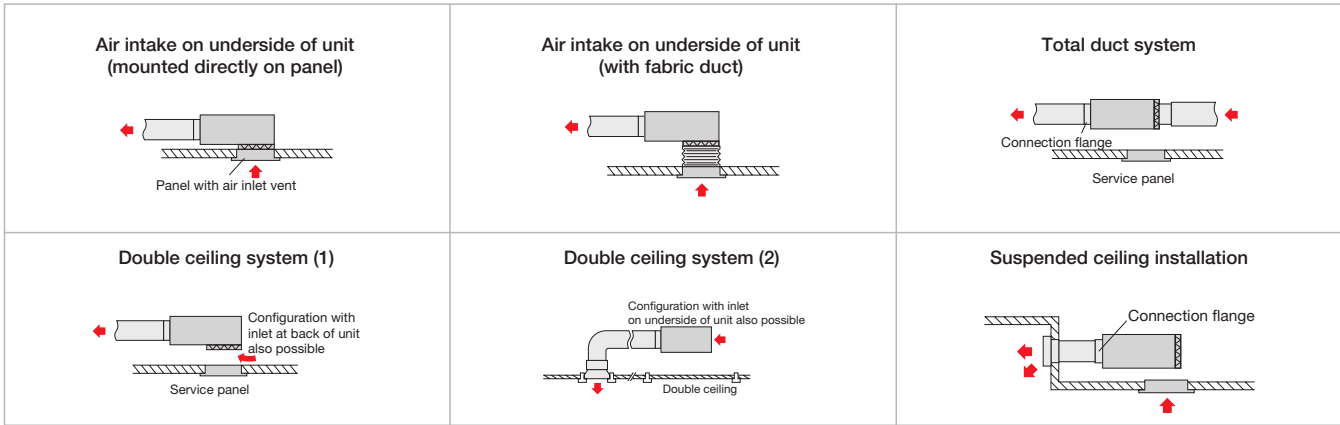

## TECHNICAL SPECIFICATIONS

MODEL		PEFY-P20VMR-E-L	PEFY-P25VMR-E-L	PEFY-P32VMR-E-L
<b>Power</b>		A single phase, 220-230-240V 50Hz / a single phase fase, 220-230V 60Hz		
<b>Capacity in cooling mode</b> *1	kW	2.2	2.8	3.6
	Btu/h	7,500	9,600	12,300
<b>Capacity in heating mode</b> *1	kW	2.5	3.2	4.0
	Btu/h	8,500	10,900	13,600
<b>Power consumption</b>	Cooling kW	0.06 / 0.06	0.06 / 0.06	0.07 / 0.08
	Heating kW	0.06 / 0.06	0.06 / 0.06	0.07 / 0.08
<b>Current</b>	Cooling A	0.29 / 0.29	0.29 / 0.29	0.34 / 0.38
	Heating A	0.29 / 0.29	0.29 / 0.29	0.34 / 0.38
<b>External finish</b>	kg	Galvanised		
<b>Dimensions (HxLxW)</b>	Rear air intake mm	292x640x580		
	Air intake under unit mm	300x640x570		
<b>Net weight</b>	kg	18		
<b>Heat exchanger</b>		Cross fins (sheet aluminium fins and copper piping)		
<b>Fan</b>	Type x Quantity	Scirocco fan x 1		
	Air flow (low-medium-high) m <sup>3</sup> /min	4.8-5.8-7.9		4.8-5.8-9.3
	Static extern. pressure Pa	5		
<b>Motor</b>	Type	Single-phase induction motor		
	Power output kW	0.018		0.023
<b>Air filter</b>		Polypropylene honeycomb fabric (washable)		
<b>Refrigerant pipe diameter</b>	Gas mm	ø12.7 brazed		
	Liquid mm	ø6.35 brazed		
<b>Local drain pipe diameter</b>		O.D. 26		
<b>Sound pressure (low-medium-high)*2</b>	220V dB(A)	20-25-30		20-25-33
	230V dB(A)	21-26-32		21-26-35
	240V dB(A)	22-27-30		22-27-33

\*1 For heating/cooling capacity, the maximum value with the unit operating in the following conditions is given.

Cooling: indoor 27°C (81°F) DB/19°C (66°F) WB, outdoor 35°C (95°F) DB. Heating: indoor 20°C (68°F) DB, outdoor 7°C (45°F) DB/6°C (43°F) WB.

\*2 Measured in anechoic chamber. Noise levels for unit with rear air intake (noise levels are higher than with an air intake on underside of unit).

# CITY MULTI PEFY-P VMS1-E

INDOOR UNIT - BUILT-IN FOR DOUBLE CEILINGS  
MEDIUM TO LOW STATIC PRESSURE

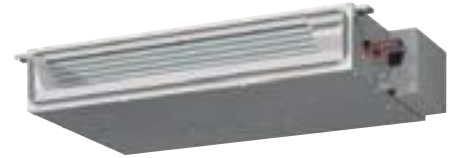

This **ultra-slim 200 mm** unit offers extraordinary flexibility and is particularly suitable for use in rooms where low noise and compact vertical dimensions are essential.

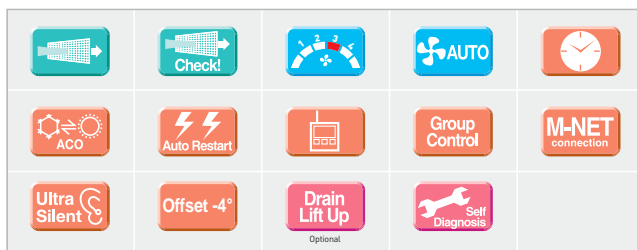

## Ultra-slim

These units are extremely thin, at just 200 mm in height. Extremely compact width and lengths of:

**7790 mm** for P15 and P32 models  
**990 mm** for P40 and P50 models  
**1190 mm** for P63 models

May be installed easily in cramped spaces such as ceiling recesses or double ceilings.

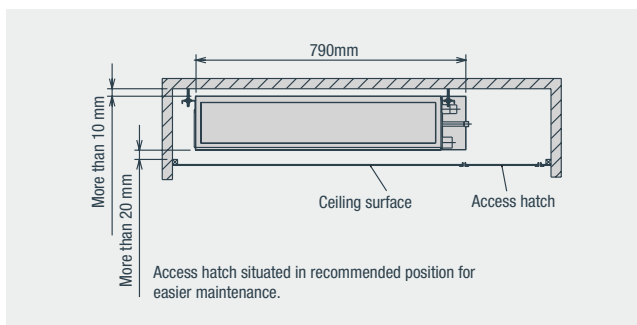

## Condensate lift pump

The VMS1 is equipped with a condensate lift pump as standard.

## Adjustable static pressure

With 4 selectable static pressure settings (5, 15, 25 and 50Pa), this unit is ideal for a variety of different applications.

## Adjustable air flow

Three different fan speed settings - "low", "medium" and "high" - ensure the desired levels of comfort.

## Low noise

The new design of the centrifugal fan and coil reduces noise levels.

		dB(A)							
NOISE LEVEL	Fan speed	Capacity	P15	P20	P25	P32	P40	P50	P63
		High		28		32	33	35	36
		Medium		24		27	30	32	33
		Low		22		24	28	30	30

## TECHNICAL SPECIFICATIONS

MODEL		PEFY-P15VMS1-E	PEFY-P20VMS1-E	PEFY-P25VMS1-E	PEFY-P32VMS1-E	PEFY-P40VMS1-E	PEFY-P50VMS1-E	PEFY-P63VMS1-E	
<b>Power</b>		A single-phase, 220-240V, 50Hz / a single-phase, 200V, 60Hz							
<b>Capacity in cooling mode</b> <sup>*1</sup>	kW	1.7	2.2	2.8	3.6	4.5	5.6	7.1	
	Btu/h	5,800	7,500	9,600	12,300	15,400	19,100	24,200	
<b>Capacity in heating mode</b> <sup>*1</sup>	kW	1.9	2.5	3.2	4.0	5.0	6.3	8.0	
	Btu/h	6,500	8,500	10,900	13,600	17,100	21,500	27,300	
<b>Power consumption</b>	Cooling <sup>*3</sup>	kW	0.05 [0.03]	0.05 [0.03]	0.06 [0.04]	0.07 [0.05]	0.07 [0.05]	0.09 [0.07]	0.09 [0.07]
	Heating <sup>*3</sup>	kW	0.03 [0.03]	0.03 [0.03]	0.04 [0.04]	0.05 [0.05]	0.05 [0.05]	0.07 [0.07]	0.07 [0.07]
<b>Current</b>	Cooling <sup>*3</sup>	A	0.42 [0.31]	0.47 [0.36]	0.50 [0.39]	0.50 [0.39]	0.56 [0.45]	0.67 [0.56]	0.72 [0.61]
	Heating <sup>*3</sup>	A	0.31 [0.31]	0.36 [0.36]	0.39 [0.39]	0.39 [0.39]	0.45 [0.45]	0.56 [0.56]	0.61 [0.61]
<b>External finish</b>	kg	Galvanised							
<b>Dimensions HxLxW</b>	mm	200x790x700			200x990x700		200x1,190x700		
<b>Net weight</b> <sup>*3</sup>	kg	19 [18]		20 [19]		24 [23]		28 [27]	
<b>Heat exchanger</b>	Cross fins (sheet aluminium fins and copper piping)								
<b>Fan</b>	Type x Quantity	Scirocco fan x 2				Scirocco fan x 3		Ventil. Scirocco x 4	
	Air flow (low-medium-high)	m <sup>3</sup> /min	5-6-7	5.5-6.5-8	5.5-7-9	6-8-10	8-9.5-11	9.5-11-13	12-14-16.5
	Static external press. <sup>*2</sup> Pa	5-15-35-50							
<b>Motor</b>	Type	Brushless DC motor							
	Power output	kW	0.096						
<b>Air filter</b>	Polypropylene honeycomb fabric (washable)								
<b>Refrigerant pipe diameter</b>	Gas	mm	ø12.7, brazed					ø15.88, brazed	
	Liquid	mm	ø6.35, brazed					ø9.52, brazed	
<b>Local drain pipe diameter</b>	O.D. 32								
<b>Sound pressure (low-medium-high)</b>	dB(A)	22-24-28	23-25-29	24-26-30	24-27-32	28-30-33	30-32-35	30-33-36	

<sup>\*1</sup> For heating/cooling capacity, the maximum value with the unit operating in the following conditions is given.  
Cooling: indoor 27°C DB/19°C WB, outdoor 35°C DB.  
Heating: indoor 20°C DB (68°F DB), outdoor 7°C DB (45°F DB/43°F WB). Pipe length: 7.5 m (24-9/16 feet).  
Height difference: 0 m (0 feet).

<sup>\*2</sup> Static external pressure is set to 15 Pa by default.

<sup>\*3</sup> [ ] in case of PEFY-P15-63VMS1L-E.

# CITY MULTI PEFY-P VMA-E

INDOOR UNIT - BUILT-IN FOR DOUBLE CEILINGS  
MEDIUM TO HIGH STATIC PRESSURE



Featuring very precise ambient temperature control, the VMA(L) series ducted unit offers **unparalleled energy efficiency**.

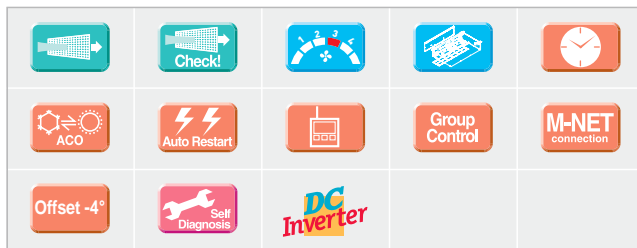

## Compact unit

The entire VMA(L) series offers extraordinarily compact dimensions: measuring just 250 mm in height, this is the perfect solution for installation in cramped spaces.

## Condensate lift pump

The VMA is equipped with a condensate lift pump.

## Static pressure

Static external pressure is adjustable to suit the system configuration and installation conditions. The static pressure may be modified to cater for all types of ducting and to allow for functional upgrades such as installing high performance filters, etc. To cater for different layouts and configurations, the static pressure is adjustable within a range from 35Pa to 150 Pa\*.

\* Default setting 50Pa.

## Intake on underside of unit

During installation, the unit may be configured with the air intake on the underside.

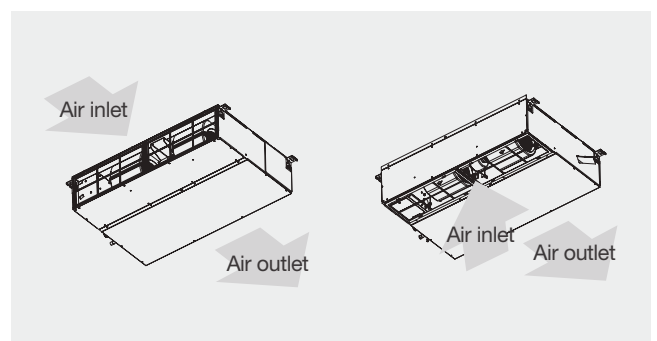

## TECHNICAL SPECIFICATIONS

MODEL		PEFY-P20VMA-E	PEFY-P25VMA-E	PEFY-P32VMA-E	PEFY-P40VMA-E	PEFY-P50VMA-E	PEFY-P63VMA-E	
<b>Power</b>		A single-phase, 220-240V, 50Hz						
<b>Capacity in cooling mode</b> *1	kW	2.2	2.8	3.6	4.5	5.6	7.1	
	Btu/h	7,500	9,600	12,300	15,400	19,100	24,200	
<b>Capacity in heating mode</b> *1	kW	2.5	3.2	4.0	5.0	6.3	8.0	
	Btu/h	8,500	10,900	13,600	17,100	21,500	27,300	
<b>Power consumption</b>	Cooling	kW	0.06	0.06	0.07	0.09	0.11	
	Heating	kW	0.04	0.04	0.05	0.07	0.09	
<b>Current</b>	Cooling	A	0.53	0.53	0.55	0.64	0.74	
	Heating	A	0.42	0.42	0.44	0.53	0.63	
<b>External finish</b>	kg	Galvanised steel plate						
<b>Dimensions HxLxW</b>	mm	250x700x732			250x900x732		250x1,100x732	
<b>Net weight</b>	kg	23			26		32	
<b>Heat exchanger</b>	Cross fins (sheet aluminium fins and copper piping)							
<b>Fan</b>	Type x Quantity	Scirocco fan x 1					Scirocco fan x 2	
	Air flow (low-medium-high)	m <sup>3</sup> /min	6.0-7.5-8.5	6.0-7.5-8.5	7.5-9.0-10.5	10.0-12.0-14.0	12.0-14.5-17.0	13.5-16.0-19.0
		l/s	100-125-142	100-125-142	125-150-175	167-200-233	200-242-283	225-267-317
		cfm	212-265-300	212-265-300	265-318-371	353-424-494	424-512-600	477-565-671
Static external press.	Pa	35/50/70/100/150						
<b>Motor</b>	Type	Single-phase brushless DC motor						
	Power output	kW	0.085					0.121
<b>Air filter</b>	Polypropylene honeycomb fabric (washable)							
<b>Refrigerant pipe diameter</b>	Gas (swaged)	mm	ø6.35				ø9.52	
	Liquid (swaged)	mm	ø12.7				ø15.88	
<b>Local drain pipe diameter</b>	O.D. 32 (1-1/4)							
<b>Sound pressure (low-medium-high)</b> *2	dB(A)	26-28-29	26-28-29	28-30-34	28-30-34	28-32-35	29-32-36	

## TECHNICAL SPECIFICATIONS

MODEL		PEFY-P71VMA-E	PEFY-P80VMA-E	PEFY-P100VMA-E	PEFY-P125VMA-E	PEFY-P140VMA-E	
<b>Power</b>		A single-phase, 220-240V, 50Hz					
<b>Capacity in cooling mode</b> *1	kW	8.0	9.0	11.2	14.0	16.0	
	Btu/h	27,300	30,700	38,200	47,800	54,600	
<b>Capacity in heating mode</b> *1	kW	9.0	10.0	12.5	16.0	18.0	
	Btu/h	30,700	34,100	42,700	54,600	61,400	
<b>Power consumption</b>	Cooling	kW	0.14	0.14	0.24	0.34	
	Heating	kW	0.12	0.12	0.22	0.32	
<b>Current</b>	Cooling	A	1.15	1.15	1.47	2.05	
	Heating	A	1.04	1.04	1.36	1.94	
<b>External finish</b>	kg	Galvanised steel plate					
<b>Dimensions HxLxW</b>	mm	250x1,100x732			250x1,400x732		250x1,600x732
<b>Net weight</b>	kg	32			42		46
<b>Heat exchanger</b>	Cross fins (sheet aluminium fins and copper piping)						
<b>Fan</b>	Type x Quantity	Scirocco fan x 2					
	Air flow (low-medium-high)	m <sup>3</sup> /min	14.5-18.0-21.0	14.5-18.0-21.0	23.0-28.0-33.0	28.0-34.0-40.0	29.5-35.5-42.0
		l/s	242-300-350	242-300-350	383-467-550	467-567-667	492-592-700
		cfm	512-636-742	512-636-742	812-989-1,165	989-1,201-1,412	1,042-1,254-1,483
Static external pres.	Pa	35/50/70/100/150					
<b>Motor</b>	Type	Single-phase brushless DC motor					
	Power output	kW	0.121			0.244	
<b>Air filter</b>	Polypropylene honeycomb fabric (washable)						
<b>Refrigerant pipe diameter</b>	Gas (swaged)	mm	ø9.52				
	Liquid (swaged)	mm	ø15.88				
<b>Local drain pipe diameter</b>	O.D. 32 (1-1/4)						
<b>Sound pressure (low-medium-high)</b> *2	dB(A)	30-34-38	30-34-38	32-37-41	35-40-44	36-41-45	

\*1 For heating/cooling capacity, the maximum value with the unit operating in the following conditions is given.

Cooling: indoor 27°C (81°F) DB/19°C (66°F) WB, outdoor 35°C (95°F) DB.

Heating: indoor 20°C (68°F) DB, outdoor 7°C (45°F) DB/6°C (43°F) WB.

\*2 Measured in anechoic chamber.

# CITY MULTI PEFY-P VMH-E

INDOOR UNIT - BUILT-IN FOR DOUBLE CEILINGS  
HIGH STATIC PRESSURE



The greater flexibility offered by the capability of setting different static external pressure levels makes creating a true ducted air conditioning system possible without compromising the style of an elegant interior design.

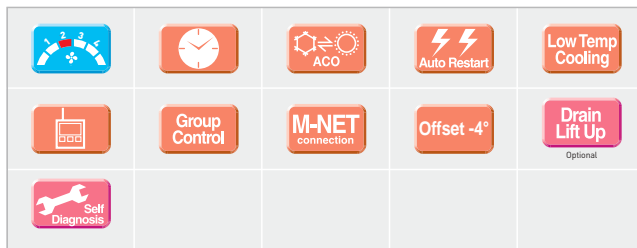

## Simplified maintenance

All maintenance operations for the unit, including checking the fan and removing the relative motor, are performed via a specific service access aperture on one side.

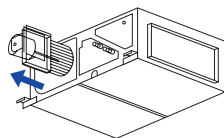

## Condensate lift pump with maximum lift

The additional of the optional condensate lift pump makes it possible to place the drain connection up to 550 m above the unit, for superlative freedom in defining pipe layouts and reducing the need for horizontal pipes.

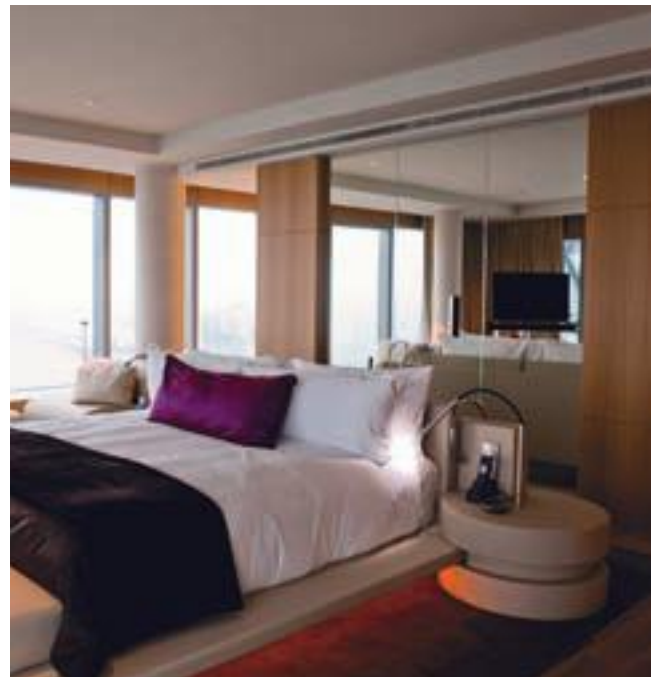
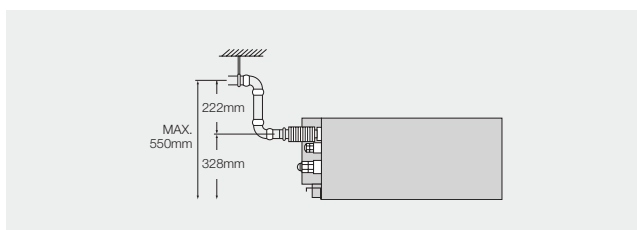

## Maximum static external pressure 200 Pa

The augmented static external pressure capacity offers greater flexibility in terms of ducting length, the use of two-way branch pipes and air outlet configuration.

		dB(A)							
		P40	P50	P63	P71	P80	P100	P125	P140
Static external pressure (Pa)	220V	50/100/200							
	230/240V	100/150/200							
	380V	-							
	400/415V	-							

## Low noise

The new design of the centrifugal fan and motor coil further reduces noise levels.

		dB(A)							
Noise level	Capacità	P40	P50	P63	P71	P80	P100	P125	P140
	Fan speed	High	34	34	38	39	41	42	42
Low	27	27	32	32	35	34	34	34	

## TECHNICAL SPECIFICATIONS

MODEL		PEFY-P40VMH-E	PEFY-P50VMH-E	PEFY-P63VMH-E	PEFY-P71VMH-E
<b>Power</b>		A single-phase, 220-240V, 50Hz / a single-phase, 220-240V, 50Hz			
<b>Capacity in cooling mode</b> *1	kW	4.5	5.6	7.1	8.0
	Btu/h	15,400	19,100	24,200	27,300
<b>Capacity in heating mode</b> *1	kW	5.0	6.3	8.0	9.0
	Btu/h	17,100	21,500	27,300	30,700
<b>Power consumption</b>	Cooling	kW 0.19 / 0.23		0.24 / 0.30	0.26 / 0.33
	Heating	kW 0.19 / 0.23		0.24 / 0.30	0.26 / 0.33
<b>Current</b>	Cooling	A 0.88 / 1.06		1.12 / 1.38	1.20 / 1.51
	Heating	A 0.88 / 1.06		1.12 / 1.38	1.20 / 1.51
<b>External finish</b>	kg	Galvanised			
<b>Dimensions HxLxW</b>	mm	380x750x900			380x1,000x900
<b>Net weight</b>	kg	44	45	50	
<b>Heat exchanger</b>		Cross fins (aluminium fins and copper piping)			
<b>Fan</b>	Type x Quantity	Scirocco fan x 1			
	Air flow (low-high)	m <sup>3</sup> /min	10.0-14.0	13.5-19.0	15.5-22.0
		l/s	167-233	225-317	258-367
		cfm	353-494	477-671	547-777
	Static external pressure*2	220V Pa	50 · 100 · 200		
230,240 V Pa		100 · 150 · 200			
<b>Motor</b>	Type	Single-phase induction motor			
	Power output	kW 0.08		0.12	0.14
<b>Refrigerant pipe diameter</b>	Gas (swaged)	mm $\phi$ 12.7		$\phi$ 15.88	$\phi$ 15.88
	Liquid (swaged)	mm $\phi$ 6.35		$\phi$ 9.52	$\phi$ 9.52
<b>Local drain pipe diameter</b>		O.D. 32			
<b>Sound pressure (low-high)</b> *3	220V	dB(A) 27-34		32-38	32-39
	230,240 V	dB(A) 31-37		36-41	35-41

## TECHNICAL SPECIFICATIONS

MODEL		PEFY-P80VMH-E	PEFY-P100VMH-E	PEFY-P125VMH-E	PEFY-P140VMH-E
<b>Power</b>		A single-phase, 220-240V, 50Hz / a single-phase, 220-240V, 50Hz			
<b>Capacity in cooling mode</b> *1	kW	9.0	11.2	14.0	16.0
	Btu/h	30,700	38,200	47,800	54,600
<b>Capacity in heating mode</b> *1	kW	10.0	12.5	16.0	18.0
	Btu/h	34,100	42,700	54,600	61,400
<b>Power consumption</b>	Cooling	kW 0.32 / 0.40		0.48 / 0.58	0.48 / 0.59
	Heating	kW 0.32 / 0.40		0.48 / 0.58	0.48 / 0.59
<b>Current</b>	Cooling	A 1.47 / 1.83		2.34 / 2.66	2.35 / 2.70
	Heating	A 1.47 / 1.83		2.34 / 2.66	2.35 / 2.70
<b>External finish</b>	kg	Galvanised			
<b>Dimensions HxLxW</b>	mm	380x1,000x900		380x1,200x900	
<b>Net weight</b>	kg	50	70		
<b>Heat exchanger</b>		Cross fins (aluminium fins and copper piping)			
<b>Fan</b>	Type x Quantity	Scirocco fan x 1			
	Air flow (low-high)	m <sup>3</sup> /min	18.0-25.0	26.5-38.0	28.0-40.0
		l/s	300-417	442-633	467-667
		cfm	636-883	936-1342	989-1413
	Static external pressure*2	220V Pa	50 · 100 · 200		
230,240 V Pa		100 · 150 · 200			
<b>Motor</b>	Type	Single-phase induction motor			
	Power output	kW 0.18		0.26	
<b>Refrigerant pipe diameter</b>	Gas (swaged)	mm $\phi$ 15.88			
	Liquid (swaged)	mm $\phi$ 9.52			
<b>Local drain pipe diameter</b>		O.D. 32			
<b>Sound pressure (low-high)</b> *3	220V	dB(A) 35-41		34-42	
	230,240 V	dB(A) 38-43		38-44	

\*1 For heating/cooling capacity, the maximum value with the unit operating in the following conditions is given.

Cooling: indoor 27°C (81°F) DB/19°C (66°F) WB, outdoor 35°C (95°F) DB. Heating: indoor 20°C (68°F) DB, outdoor 7°C (45°F) DB/6°C (43°F) WB.

\*2 Static pressure is set to 100 Pa (for 220 V mains) / 150 Pa (for 230 and 240 V mains) by default.

\*3 Measured in anechoic chamber.

# CITY MULTI PEFY-P VMHS-E

INDOOR UNIT - BUILT-IN FOR DOUBLE CEILINGS  
HIGH STATIC PRESSURE



The new VMHS series: improved **installation flexibility** and superior performance.

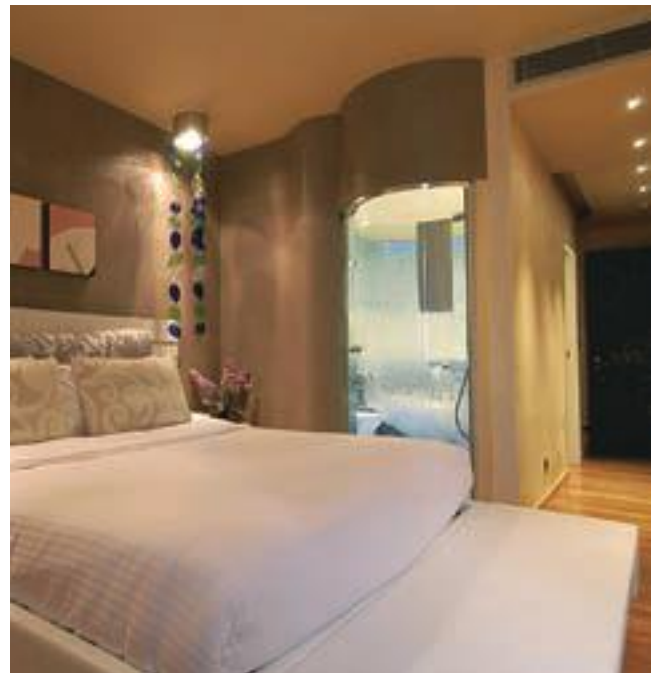
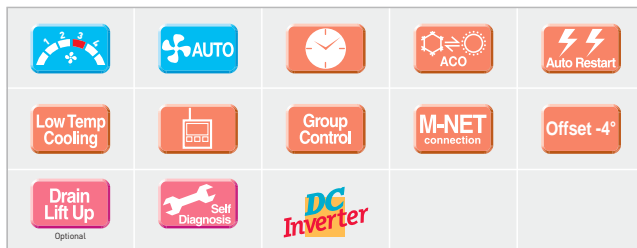

## DC Inverter motor

The new VMHS ducted indoor units are equipped with a single-phase DC Inverter electric motor, a solution that offers more precise electronic control and less noise.

## Remotely settable static overpressure

The static overpressure may be modified from a remote control. In addition to a dip switch on the unit, the PAR-30MAA remote control may also be used to modify static external pressure, making installation significantly simpler.

A choice of up to five different settings is available: 50, 100, 150, 200 or 250 Pa.

## Automatic fan speed adjustment

The automatic fan speed adjustment mode ensures fast, comfortable heating as soon as heating mode is activated. Automatic fan speed control is included in the three standard modes "Low", "Medium" and "High", and ensures faster, comfortable air conditioning by increasing the air flow speed on activation and then reducing speed once stable comfort levels are attained.

## Quieter

The VMHS series is 15% quieter than the previous VMH model.



## TECHNICAL SPECIFICATIONS

MODEL		PEFY-P200VMHS-E	PEFY-P250VMHS-E
<b>Power</b>		A single-phase, 220-240V, 50Hz	
<b>Capacity in cooling mode</b> *1	kW	22.4	28.0
	Btu/h	76,000	95,500
<b>Capacity in heating mode</b> *1	kW	25.0	31.5
	Btu/h	72,300	90,400
<b>Power consumption</b>	Heating kW	0.63/0.63/0.63	0.82/0.82/0.82
	Cooling kW	0.63/0.63/0.63	0.82/0.82/0.82
<b>Current</b>	Heating A	3.47/3.32/3.18	4.72/4.43/4.14
	Cooling A	3.47/3.32/3.18	4.72/4.43/4.14
<b>External finish</b>	kg	Galvanised	
<b>Dimensions (HxLxW)</b>	mm	470 x 1250 x 1120	
<b>Net weight</b>	kg	97	100
<b>Heat exchanger</b>		Cross Fin	
<b>Fan</b>	Type x Quantity	Scirocco x 2	
	Air flow (low-medium-high) m <sup>3</sup> /min	50-61-72	58-71-84
	Static external pres.*2 Pa	(50)/(100)/150/(200)/(250)	
<b>Motor</b>	Type	Single-phase induction motor	
	Power output kW	0.87	
<b>Air filter</b>		-	
<b>Refrigerant pipe diameter</b>	Gas mm	19.05	22.2
	Liquid mm	9.52	9.52
<b>Local drain pipe diameter</b>		32	
<b>Sound pressure (low-medium-high)*3</b>	dB(A)	36-39-43	39-42-46

\*1 For heating/cooling capacity, the maximum value with the unit operating in the following conditions is given:  
Cooling: 27°C DB / 19°C WB, outdoor 35°C DB. Heating: 27°C DB, outdoor 7°C DB / 6°C WB.

\*2 Static pressure is set to 150 Pa by default.

\*3 Measured in anechoic chamber.

# CITY MULTI PCFY-P VKM-E

INDOOR UNIT - CEILING-SUSPENDED



Designed and built for quiet operation and **simple maintenance**, these units deliver **efficient, comfortable** air conditioning performance.

Pure White	AUTO VANE	Fresh-air Intake	Long Life	Check!
5	SWING	1 2 3	AUTO	High Ceiling
Low Ceiling		ACO	Auto Restart	
Group Control	M-NET connection	Offset -4°	Self Diagnosis	

## Optimised air flow

Air flow speed is optimised for the height of the ceiling. The ideal air flow setting may be selected for ceilings up to 4.2m in height, maximising both air conditioning efficacy and comfort.

## Extremely simple installation

With the direct mount system, it is not necessary to remove the mounting from the main unit, cutting installation times.

The condensate drain pipes may be connected on the left or right of the unit.

## Automatic fan speed adjustment

As well as the 4 manual fan speed settings, the PCFY series may also be set to automatically adjust fan speed in relation to ambient conditions: the fan speed is always set to the highest setting when the unit is switched on, to reach the desired conditions more quickly, and is reduced automatically near the setpoint for stable comfort.



## Extra-slim

Extremely slim and with elegant curves, the PCFY series is perfectly suited to any interior. The unit also features a single air outlet, meaning that the automatic swing vane also doubles as a shutter when the unit is off.



## Automatic swing vane

The automatic swing vane mode distributes air more uniformly. The vane swings upwards and downwards automatically to distribute air effectively into every corner of the room.

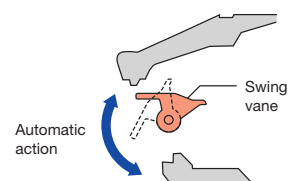

## TECHNICAL SPECIFICATIONS

MODEL		PCFY-P40VKM-E	PCFY-P63VKM-E	PCFY-P100VKM-E	PCFY-P125VKM-E	
<b>Power</b>		A single-phase, 220-240V, 50Hz				
<b>Capacity in cooling mode</b> *1	kW	4.5	7.1	11.2	14.0	
	Btu/h	15,400	24,200	38,200	47,800	
<b>Capacity in heating mode</b> *1	kW	5.0	8.0	12.5	16.0	
	Btu/h	17,100	27,300	42,700	54,600	
<b>Power consumption</b>	Heating	kW	0.04	0.05	0.09	0.11
	Cooling	kW	0.04	0.05	0.09	0.11
<b>Current</b>	Heating	A	0.28	0.33	0.65	0.76
	Cooling	A	0.28	0.33	0.65	0.76
<b>External finish</b>	kg	Munsell 6.4Y 8.9/ 0.4				
<b>Dimensions (HxLxW)</b>	mm	230x960x680	230x1,280x680	230x1,600x680		
<b>Net weight</b>	kg	24	32	36	38	
<b>Heat exchanger</b>		Cross fins (aluminium fins and copper piping)				
<b>Fan</b>	Type x Quantity	Scirocco fan x 2	Scirocco fan x 3	Scirocco fan x 4		
	Air flow*2	m <sup>3</sup> /min	10-11-12-13	14-15-16-18	21-24-26-28	21-24-27-31
		l/s	167-183-200-217	233-250-267-300	350-400-433-467	350-400-450-517
		cfm	353-388-424-459	494-530-565-636	742-847-918-989	742-847-953-1,095
Static external pres.	Pa	0				
<b>Motor</b>	Type	Single-phase DC motor				
	Power output	kW	0.090	0.095	0.160	
<b>Air filter</b>		Polypropylene honeycomb fabric (long life)				
<b>Refrigerant pipe diameter</b>	Gas (swaged)	mm	ø12.7	ø15.88	ø15.88 / ø19.05 (compatible)	
	Liquid (swaged)	mm	ø6.35	ø9.52		
<b>Local drain pipe diameter</b>		O.D. 26 (1)				
<b>Sound pressure</b> *2*3	dB(A)	29-32-34-36	31-33-35-37	36-38-41-43	36-39-42-44	

\*1 For heating/cooling capacity, the maximum value with the unit operating in the following conditions is given.

Cooling: indoor 27°C (81°F) DB/19°C (66°F) WB, outdoor 35°C (95°F) DB. Heating: indoor 20°C (68°F) DB, outdoor 7°C (45°F) DB/6°C (43°F) WB.

\*2 Air flow/noise levels given for operation in low-medium1-medium2-high modes.

\*3 Measured in anechoic chamber.

# CITY MULTI

## PKFY-P VBM-E

## PKFY-P VHM-E

## PKFY-P VKM-E

INDOOR UNIT - WALL-MOUNTED



PKFY-P VHM



PKFY-P VBM



PKFY-P VKM

An elegant design with simple, clean lines, compact dimensions and a distinctly recognisable family look: **the ideal solution for residential applications, offices and large stores.**



### VHM (P32-P50)

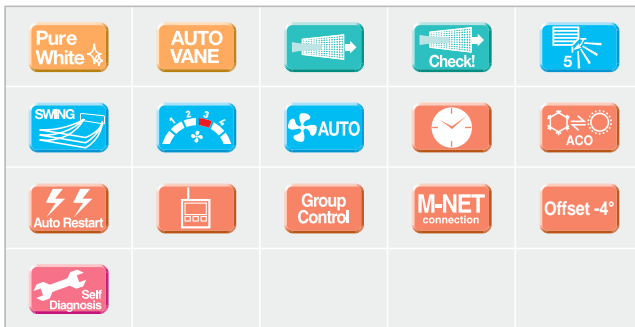

### VBM (P15-P25)



### VKM (P63-P100)



### A choice of 5 installation configurations

A choice of 5 different piping configurations offers extraordinary installation flexibility.

All the pipes, including the condensate drain line, may be connected to the back, left or right hand sides or base of the unit, for total flexibility in routing the pipelines and choosing the ideal location for the installation.

### Smooth front panel with pure white finish

All the models of the PKFY series now feature a smooth front panel instead of the mesh used on the previous version. The units themselves are now finished in pure white instead of standard appliance white to fit in perfectly with the style of practically any interior space.

Capacity	P15	P20	P25	P32	P40	P50	P63	P100
VBM	●	●	●					
VHM				●	●	●		
VKM							●	●

## TECHNICAL SPECIFICATIONS

MODEL		PKFY-P15VBM-E	PKFY-P20VBM-E	PKFY-P25VBM-E	PKFY-P32VHM-E	PKFY-P40VHM-E
<b>Power</b>		A single-phase, 220-240V, 50Hz				
<b>Capacity in cooling mode</b> *1	kW	1.7	2.2	2.8	3.6	4.5
	Btu/h	5,800	7,500	9,600	15,400	15,400
<b>Capacity in heating mode</b> *1	kW	1.9	2.5	3.2	4.0	5.0
	Btu/h	6,500	8,500	10,900	13,600	17,100
<b>Power consumption</b>	Heating	kW			0.04	
	Cooling	kW			0.04	
<b>Current</b>	Heating	A			0.40	
	Cooling	A			0.30	
<b>External finish</b>	kg	Munsell plastic (1.0Y 9.2/0.2)				
<b>Dimensions (HxLxW)</b>	mm	2,295x815x225			295x898x249	
<b>Net weight</b>	kg	10			13	
<b>Heat exchanger</b>		Cross fins (aluminium fins and copper piping)				
<b>Fan</b>	Type x Quantity	Linear flow fan x 1				
	Air flow*2	m <sup>3</sup> /min	4.9-5.0-5.2-5.3	4.9-5.2-5.6-5.9	9-10-11	9-10.5-11.5
		l/s	82-83-87-88	82-87-93-98	150-167-183	150-175-192
		cfm	173-177-184-187	173-184-198-208	318-353-388	318-371-406
Static external pres.	Pa	0				
<b>Motor</b>	Type	Single-phase induction motor			DC motor	
	Power output	kW			0.030	
<b>Air filter</b>		Polypropylene honeycomb fabric (washable)				
<b>Refrigerant pipe diameter</b>	Gas (swaged)	mm		ø12.7		
	Liquid (swaged)	mm		ø6.35		
<b>Local drain pipe diameter</b>		I.D. 16 (5/8)				
<b>Sound pressure</b> *2*3	dB(A)	29-31-32-33	29-31-34-36	34-37-41	34-38-41	

## TECHNICAL SPECIFICATIONS

MODEL		PKFY-P50VHM-E	PKFY-P63VKM-E	PKFY-P100VKM-E	
<b>Power</b>		A single-phase, 220-240V, 50Hz			
<b>Capacity in cooling mode</b> *1	kW	5.6	7.1	11.2	
	Btu/h	19,100	24,200	38,200	
<b>Capacity in heating mode</b> *1	kW	6.3	8.0	12.5	
	Btu/h	21,500	27,300	42,600	
<b>Power consumption</b>	Heating	kW		0.08	
	Cooling	kW		0.07	
<b>Current</b>	Heating	A		0.58	
	Cooling	A		0.51	
<b>External finish</b>	kg	Munsell plastic (1.0Y 9.2/0.2)			
<b>Dimensions (HxLxW)</b>	mm	295x898x249	365x1170x295		
<b>Net weight</b>	kg	13	21		
<b>Heat exchanger</b>		Cross fins (aluminium fins and copper piping)			
<b>Fan</b>	Type x Quantity	Linear flow fan x 1			
	Air flow*2	m <sup>3</sup> /min	9-10.5-12	16-20	20-26
		l/s	150-175-200	267-333	333-433
		cfm	318-371-424	565-706	706-918
Static external pres.	Pa	0			
<b>Motor</b>	Type	DC motor			
	Power output	kW		0.056	
<b>Air filter</b>		Polypropylene honeycomb fabric (washable)			
<b>Refrigerant pipe diameter</b>	Gas (swaged)	mm		ø15.88 / 19.05	
	Liquid (swaged)	mm		ø9.52	
<b>Local drain pipe diameter</b>		I.D. 16 (5/8)			
<b>Sound pressure</b> *2*3	dB(A)	34-39-43	39-45	41-49	

\*1 For heating/cooling capacity, the maximum value with the unit operating in the following conditions is given.

Cooling: indoor 27°C (81°F) DB/19°C (66°F) WB, outdoor 35°C (95°F) DB. Heating: indoor 20°C (68°F) DB, outdoor 7°C (45°F) DB/6°C (43°F) WB.

\*2 Air flow/noise levels given for operation in low-medium1-medium2-high modes, in low-medium-high modes or in low-high modes, depending on model.

\*3 Measured in anechoic chamber.

# CITY MULTI



## INDOOR UNITS - CONCEALED SYSTEM



### Design innovation

**Alasplit**® is an innovative automated device for creating concealed built-in installations with wall-mounted CITY MULTI indoor units of the PKFY series. **Alasplit**® is the ideal solution to minimise the visual impact of air conditioner systems in residential, office and commercial applications. This innovative system brings an end to unsightly grey cover grilles and permanently visible air conditioner units.

**Alasplit**® is compatible with MITSUBISHI ELECTRIC VRF SYSTEMS series air conditioners.

### Easy installation

**Alasplit**® consists of two parts: **Alabox-C**, the housing for the air conditioner unit, and **Alapanel-S**, the automated front panel. The housing for the air conditioner unit may be installed in a wall recess, in a stepped ceiling, over a door or in a dedicated compartment in a bookshelf or double ceiling. After creating the suitably sized aperture in the double ceiling, **Alabox-C** is installed in the space and the Mitsubishi Electric air conditioner is then fitted into the housing. The **Alapanel-S** automated front panel covering the air conditioner unit is then simply fastened to the **Alabox-C** housing with screws.

### Create your own style

The panels making up the front cover of the **Alasplit**® system are completely personalisable with the finish and colour of the user's choice, to fit in perfectly with the style and decor of any interior.

### Controlled with a simple push of a button

The front of the **Alasplit**® system consists of three aluminium panels - a fixed centre panel and two automatically opened and closed mobile panels which function as vanes. When the air conditioner is switched on from the remote control (with PAR-FL32MA remote control only – ordered separately), the vanes of the **Alasplit**® system open automatically, allowing air into the unit and treated air into the room. When the air conditioner is switched off, the two vanes close, concealing the unit behind a simple panel with a pure, linear design to minimise the impact on the style of the interior.

### Class-beating performance and looks

The **Alasplit**® system has no effect on the performance of the Mitsubishi Electric air conditioner. The upper panel allows ambient air into the unit, while the lower panel allows treated air to circulate freely into the indoor space without impediment. **Alasplit**® also ensures superior energy efficiency, as each air conditioner unit may be set individually to optimise usage in relation to the specific needs of the surrounding space with no energy wastage. For quicker, simpler cleaning, **Alasplit**® features a simple manual opening system for the front cover.

### Compatible CITY MULTI Indoor units

The following CITY MULTI indoor units of PKFY series are compatible with **Alasplit**®:

- PKFY-P15VBM-E
- PKFY-P20VBM-E
- PKFY-P25VBM-E

## Alapanel-S

Motorised front panel

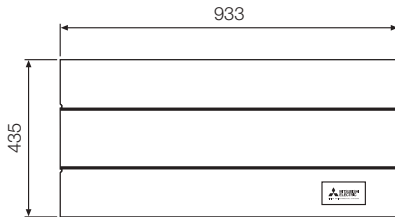

## Alabox-C

Built-in housing for wall-mounted indoor units

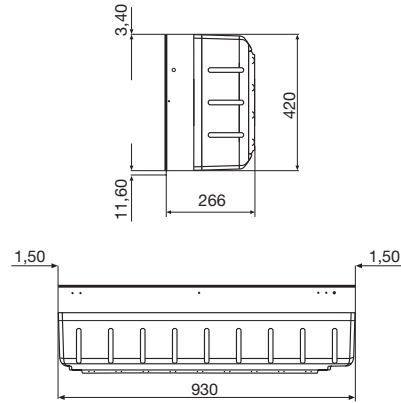

## TECHNICAL SPECIFICATIONS

MODEL			ALASPLIT®
Power consumption	Voltage/Freq./Phases	V/Hz/n°	230/50/1
		W	3
Alabox-C	HxLxW	mm	420 x 930 x 266
	Weight	kg	8,1
Alapanel-S	HxLxW	mm	435 x 933 x 3
	Weight	kg	8,6
Colour		RAL	White 3025

# CITY MULTI PAC-LV11-E

WALL-MOUNTED DESIGN INDOOR UNIT - LEV KIT



The new LEV Kit may be used to connect both standard VRF indoor units and Family series indoor units in the same CITY MULTI VRF system.

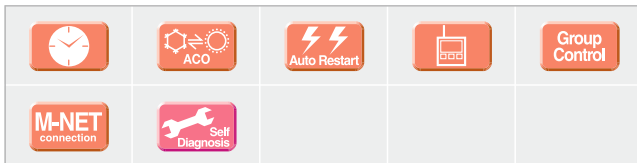

The new LEV Kit makes it possible to connect stylish residential indoor units, with looks that are perfectly suited for large installations in applications such as residential buildings and hotels, where design is a decisive factor in the choice of indoor units.

## Easy installation and maintenance

The new LEV Kit is easy to install in double ceilings or dedicated niches not only because of its compact size (183 mm H x 355 mm L x 142 mm W), but also and especially because it can be installed vertically or horizontally with no condensate drain.

Additionally, a maximum permissible piping length of 15 m between indoor units and the LEV Kit offers the freedom to install the kit in the most effective position possible.

## Family series residential indoor units

The following residential indoor units of the Family series may be connected to the LEV Kit:

Family series indoor units	15	20	22	25	35	42	50
MSZ-EF 	-	-	✓	✓	✓	✓	✓
MSZ-SF 	✓	✓	-	✓	✓	✓	✓

## Unparalleled comfort and air quality

The quality of an environment also depends on perceived noise levels. Mitsubishi Electric air conditioners connected to a VRF CITY MULTI system using the LEV Kit offer the highest levels of acoustic comfort available today on the market.

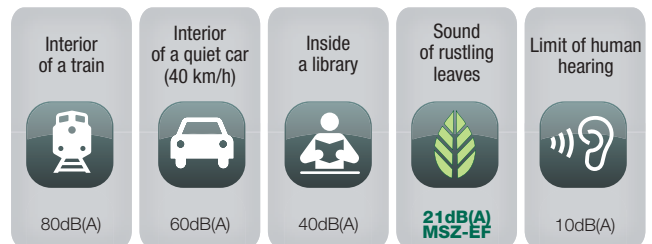

The residential indoor units of the Family series also contribute to higher air quality levels with the superior filtration power of air filters with nanoplatinum treatment.



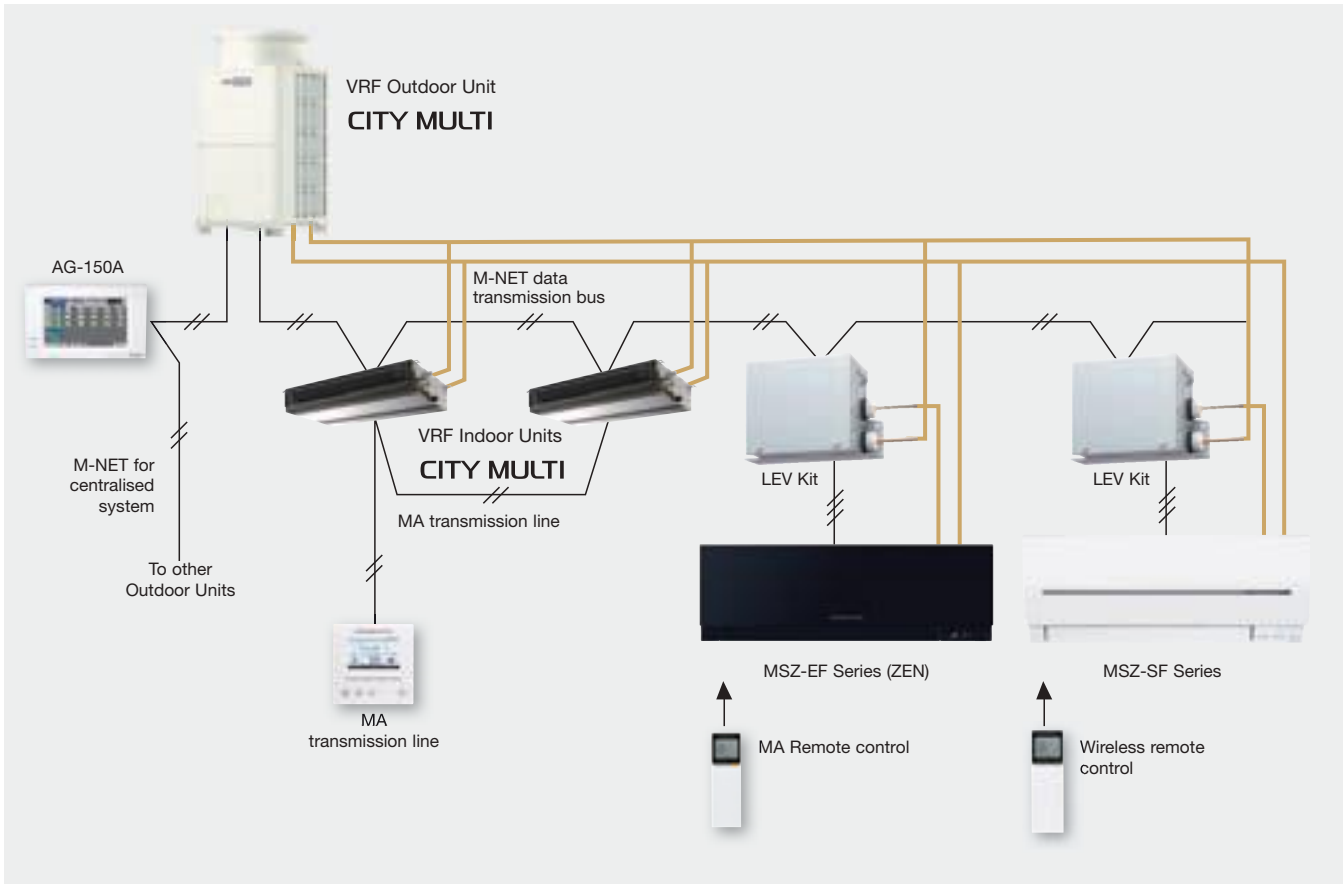

TECHNICAL SPECIFICATIONS

MODEL	PAC-LV11-E	
Power	A single-phase, 220-240V AC, 50Hz	
Compatible Family series residential indoor units	MSZ-EF (Kirigamine zen) MSZ-SF - MFZ-KJ	
Number of branches	1 way	
Maximum distance between indoor unit and LEV Kit	m	15
Compatible CITY MULTI outdoor units	Small Y Series - Y Series (Ecostandard/Nominal/Seasonal) - Y Series Zubadan (YHM) - Y Series Replace Multi (YJM), R2 Series (Nominal/Seasonal) - R2 Series Replace Multi (YJM), WY Series (YHM) - WR2 Series (YHM)	
Dimensions (HxLxW)	mm	180x355x142
Net weight	kg	3,5
Condensate drain	Not necessary	
Installation	Vertical Horizontal	
Refrigeration pipe diameter	Liquid mm Gas mm	6,35 (brazed) -
Compatible remote controls	Standard: Remote control included with optional residential indoor units of Family units (purchased separately): 1. MA wired remote control interfaced via MAC-397IF board (optional, for installation in indoor units - purchased separately). 2. ME wired remote control, interfaced via LEV Kit terminal board.	

# CITY MULTI PAC-LV11-E

FLOOR STANDING DESIGN INDOOR UNIT - LEV KIT

NEW



The new LEV Kit may be used to connect both standard VRF indoor units and Family series indoor units in the same VRF CITY MULTI system.

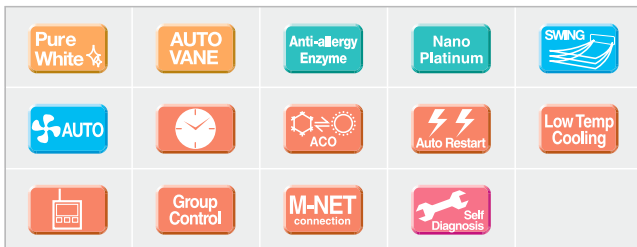

## Easy installation and maintenance

The new LEV Kit is easy to install in double ceilings or dedicated niches not only because of its compact size (183 mm H x 355 mm L x 142 mm W), but also and especially because it can be installed vertically or horizontally with no condensate drain. Additionally, a maximum permissible piping length of 15 m between indoor units and the LEV Kit offers the freedom to install the kit in the most effective position possible.

## Unparalleled comfort and air quality

The quality of an environment also depends on perceived noise levels. Mitsubishi Electric air conditioners connected to a VRF CITY MULTI system using the LEV Kit offer the highest levels of acoustic comfort available today on the market.

## Family series residential indoor units

The following variants of the MFZ-KJ floor-standing Family series indoor units may now be connected with the LEV Kit:

Family series indoor units	25	35	50
MFZ-KJ 	✓	✓	✓

## Multi-flow vane

The air delivery vent has three deflector vanes, each with a specifically designed profile to optimise the outgoing air flow and maximise comfort in both cooling and heating mode.

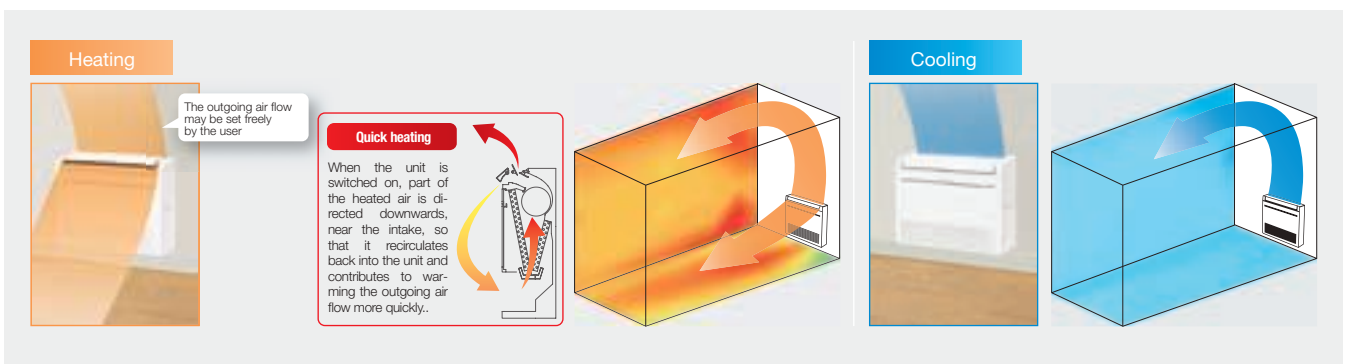

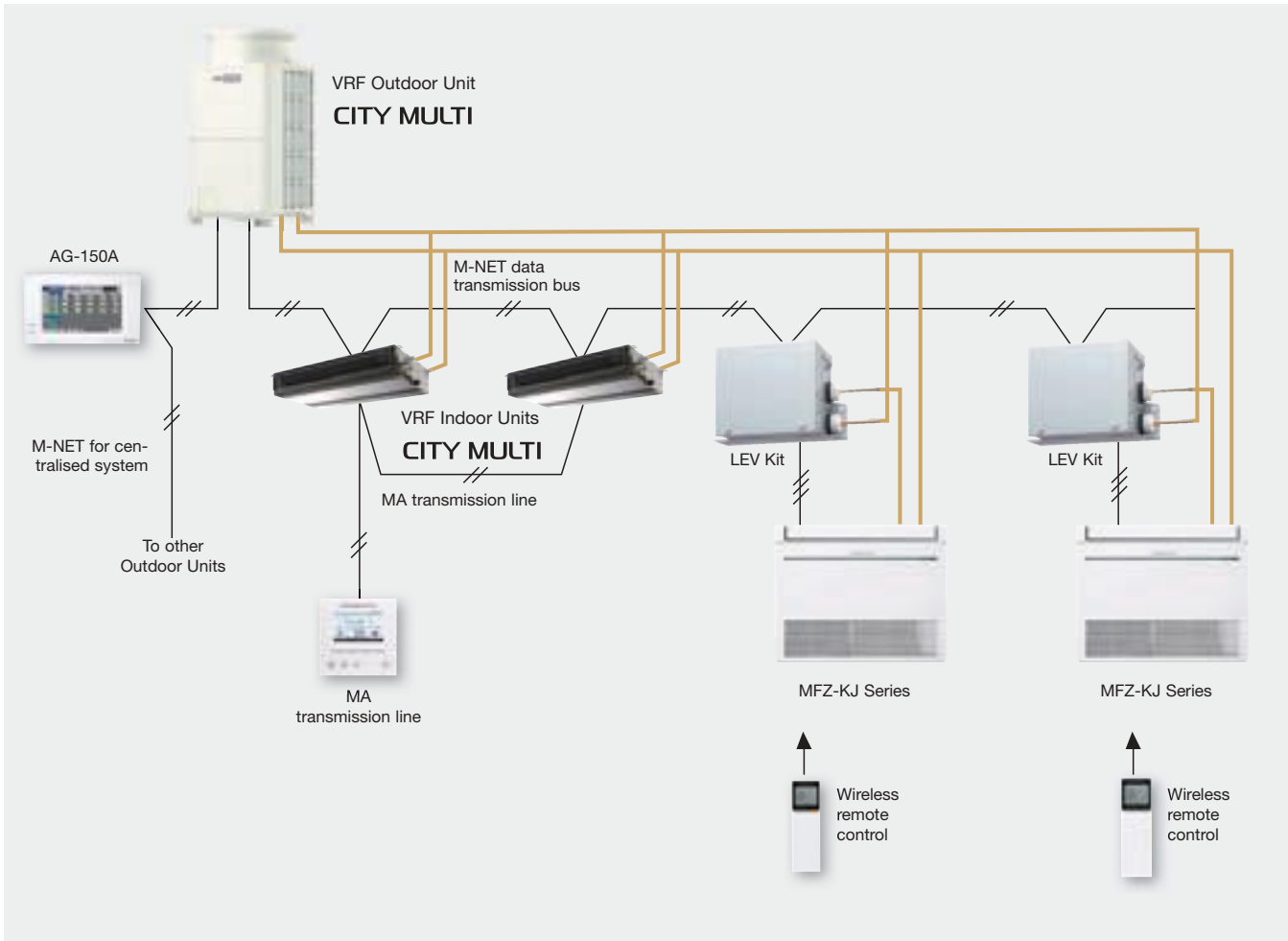

INDOOR UNITS

TECHNICAL SPECIFICATIONS

MODEL		PAC-LV11-E
Power		A single-phase, 220-240V AC, 50Hz
Compatible Family series residential indoor units		MSZ-EF (Kirigamine zen) MSZ-SF - MFZ-KJ
Number of branches		1 way
Maximum distance between indoor unit and LEV Kit	m	15
Compatible CITY MULTI outdoor units		Small Y Series - Y Series (Ecostandard/Nominal/Seasonal) - Y Series Zubadan (YHM) - Y Series Replace Multi (YJM), R2 Series (Nominal/Seasonal) - R2 Series Replace Multi (YJM), WY Series (YHM) - WR2 Series (YHM)
Dimensions (HxLxW)	mm	180x355x142
Net weight	kg	3,5
Condensate drain		Not necessary
Installation		Vertical Horizontal
Refrigeration pipe diameter	Liquid mm Gas mm	6,35 (brazed) -
Compatible remote controls		Standard: Remote control included with optional residential indoor units of Family units (purchased separately): 1. MA wired remote control interfaced via MAC-397IF board (optional, for installation in indoor units - purchased separately). 2. ME wired remote control, interfaced via LEV Kit terminal board.

# CITY MULTI PFFY-P VKM-E

INDOOR UNIT - DESIGN FLOOR-STANDING UNIT



A high performance floor-standing air conditioner unit with an **elegant design** for lounges, bedrooms or offices where style is imperative.



## Sophisticated design

A floor-standing air conditioner unit by Mitsubishi Electric boasting an innovative design and combining simple, linear lines with a wide choice of functions. Conceived to leave the walls free, a unit that delivers comfortable cooling performance in summer and pleasant heat in winter. The gloss pure white finish lends the unit a premium look suitable for any interior space. Both the upper and lower air

vents are closed when the air conditioner is switched off, giving the unit an elegantly stylish feel. A beautifully stylish and innovative air conditioner from Mitsubishi that suits your most elegant interior spaces to perfection.

## Slim but powerful

The slimline housing of the unit expresses the essence of compactness. The ideal size for a lounge, bedroom and many other rooms. The front panel is removable and washable, making the unit extremely simple to clean. Cleaning your air conditioner simply and regularly will keep it looking great and working perfectly for maximum energy efficiency.

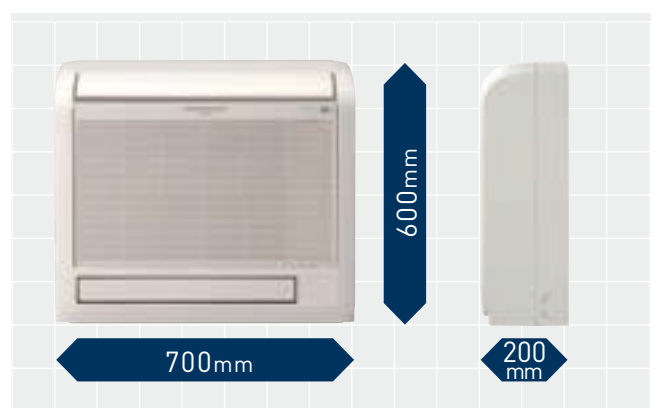

## Ideal air distribution

Air is distributed powerfully and effectively via the upper and lower air vents, ensuring a comfortable temperature throughout the room. The angle of the upper vent is settable into 5 different positions (+ swing and automatic modes) from a remote control,

while 4 different air speed settings are available. Setting the vane to an almost vertical position prevents undesirable draughts, for even greater comfort.

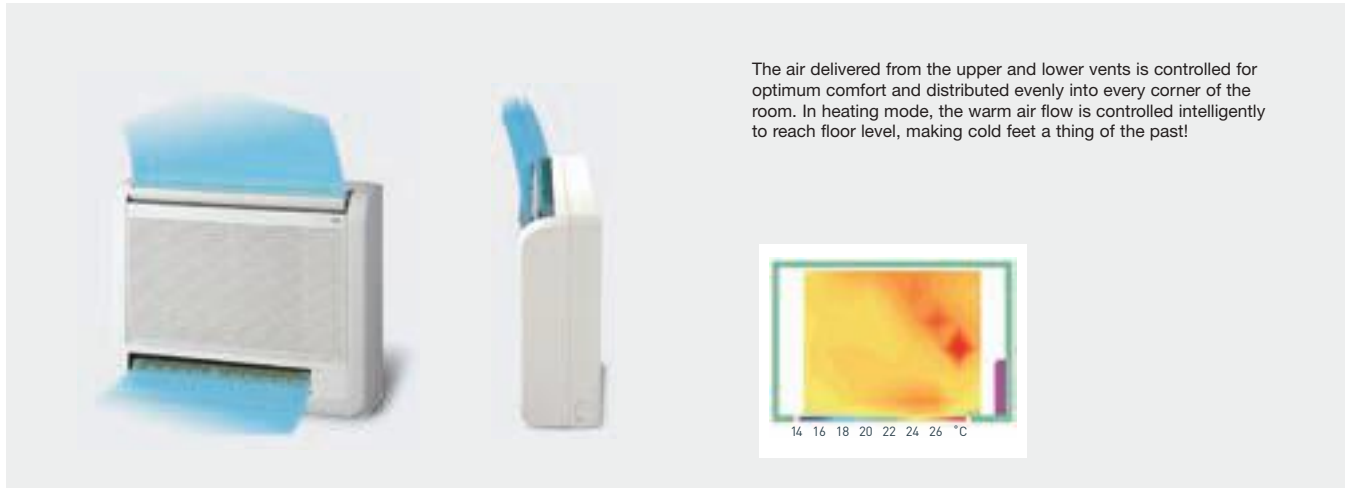

The air delivered from the upper and lower vents is controlled for optimum comfort and distributed evenly into every corner of the room. In heating mode, the warm air flow is controlled intelligently to reach floor level, making cold feet a thing of the past!

## TECHNICAL SPECIFICATIONS

MODEL		PFFY-P20VKM-E	PFFY-P25VKM-E	PFFY-P32VKM-E	PFFY-P40VKM-E	
<b>Power</b>		A single-phase, 220-240V, 50Hz				
<b>Capacity in cooling mode</b> *1	kW	2.2	2.8	3.6	4.5	
	Btu/h	7,500	9,600	12,300	15,400	
<b>Capacity in heating mode</b> *1	kW	2.5	3.2	4.0	5.0	
	Btu/h	8,500	10,900	13,600	17,100	
<b>Power consumption</b>	Heating	kW	0.025	0.025	0.025	0.028
	Cooling	kW	0.025	0.025	0.025	0.028
<b>Current</b>	Heating	A	0.20	0.20	0.20	0.24
	Cooling	A	0.20	0.20	0.20	0.24
<b>External finish</b>	kg	Plastic (pure white)				
<b>Dimensions (HxLxW)</b>	mm	600x700x200				
<b>Net weight</b>	kg	15				
<b>Heat exchanger</b>		Cross fins (aluminium fins and copper piping)				
<b>Fan</b>	Type x Quantity	Linear flow fan x 2				
	Air flow (low-medium-high-extra high)	m <sup>3</sup> /min	5.9-6.8-7.6-8.7	6.1-7.0-8.0-9.1	6.1-7.0-8.0-9.1	8.0-9.0-9.5-10.7
	Static external pres.	Pa	0			
<b>Motor</b>	Type	DC motor				
	Power output	kW	0.03x2			
<b>Air filter (optional)</b>		Polypropylene honeycomb fabric (catechin filter)				
<b>Refrigerant pipe diameter</b>	Gas (swaged)	mm	ø12.7			
	Liquid (swaged)	mm	ø6.35			
<b>Local drain pipe diameter</b>		D.I. 16 (PVC pipe connectable to VP-16)				
<b>Sound pressure (low-medium-high-extra high)*2</b>	dB(A)	27-31-34-37	28-32-35-38	28-32-35-38	35-38-42-44	

\*1 For heating/cooling capacity, the maximum value with the unit operating in the following conditions is given.

Cooling: indoor 27°C (81°F) DB/19°C (66°F) WB, outdoor 35°C (95°F) DB. Heating: indoor 20°C (68°F) DB, outdoor 7°C (45°F) DB/6°C (43°F) WB.

\*2 Measured in anechoic chamber.

# CITY MULTI PFFY-P VLEM-E

INDOOR UNIT - FLOOR STANDING UNIT



A free floor standing unit ideal for perimeter zones.

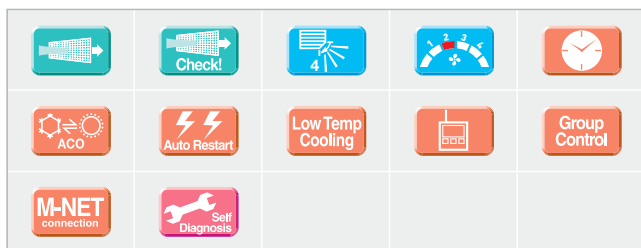

## Compact unit

A compact unit offering a simple solution for conditioning perimeter zones. The compact unit, measuring just 220 mm in depth (8-11/16"), is easily installable in perimeter areas to ensure effective conditioning performance in these zones too.

## Cooling dehumidification function

The electronic dehumidifier function uses cooling to dehumidify the air. The compact unit, measuring just 220 mm in depth, is easily installable in perimeter areas to ensure effective conditioning performance in these zones too.

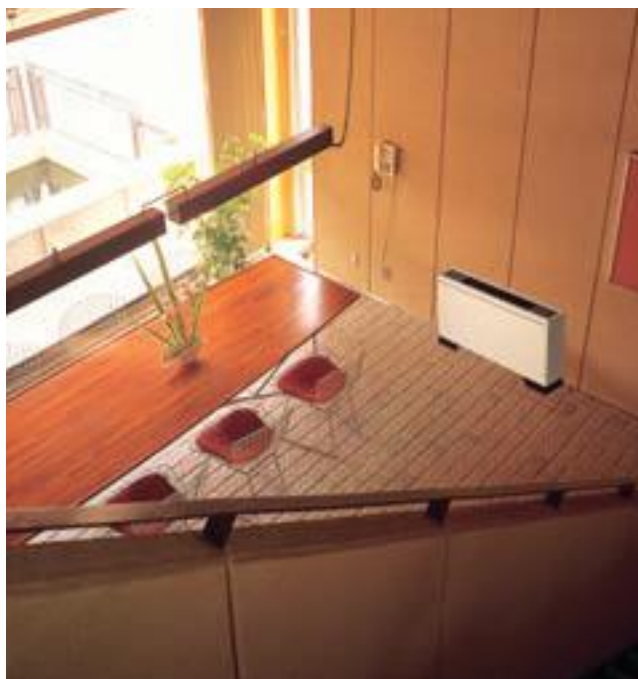

## Characteristics of PFFY-P VLEM-E

- Standardised design with simple lines.
- Suitable for all spaces, from offices and shops to hospitals.
- May be equipped with a water vapour impermeable membrane humidifier system.
- Features a specific concealed housing for stowing a remote control unit out of sight.

## TECHNICAL SPECIFICATIONS

MODEL		PFFY-P20VLEM-E	PFFY-P25VLEM-E	PFFY-P32VLEM-E	PFFY-P40VLEM-E	PFFY-P50VLEM-E	PFFY-P63VLEM-E
<b>Power</b>		A single-phase, 220-240V, 50Hz / a single-phase, 208-230V, 60Hz					
<b>Capacity in cooling mode</b> *1	kW	2.2	2.8	3.6	4.5	5.6	7.1
	Btu/h	7,500	9,600	12,300	15,400	19,100	24,200
<b>Capacity in heating mode</b> *1	kW	2.5	3.2	4.0	5.0	6.3	8.0
	Btu/h	8,500	10,900	13,600	17,100	21,500	27,300
<b>Power consumption</b>	Heating	kW 0.04 / 0.06		0.06 / 0.07	0.065 / 0.075	0.085 / 0.09	0.1 / 0.11
	Cooling	kW 0.04 / 0.06		0.06 / 0.07	0.065 / 0.075	0.085 / 0.09	0.1 / 0.11
<b>Current</b>	Heating	A 0.19 / 0.25		0.29 / 0.30	0.32 / 0.33	0.40 / 0.41	0.46 / 0.47
	Cooling	A 0.19 / 0.25		0.29 / 0.30	0.32 / 0.33	0.40 / 0.41	0.46 / 0.47
<b>External finish (Munsel number)</b>	kg	Acrylic paint (5Y 8/1)					
<b>Dimensions (HxLxW)</b>	mm	630x1,050x220		630x1,170x220		630x1,410x220	
<b>Net weight</b>	kg	23		25	26	30	32
<b>Heat exchanger</b>		Cross fins (aluminium fins and copper piping)					
<b>Fan</b>	Type x Quantity	Scirocco fan x 1			Scirocco fan x 2		
	Air flow*2	m <sup>3</sup> /min	5.5-6.5	7.0-9.0	9.0-11.0	12.0-14.0	12.0-15.5
		l/s	92-108	117-150	150-183	200-233	200-258
		cfm	194-230	247-318	318-388	424-494	424-547
Static external pres.	Pa	0					
<b>Motor</b>	Type	Single-phase induction motor					
	Power output	kW	0.015	0.018	0.030	0.035	0.050
<b>Air filter</b>		Polypropylene honeycomb fabric (washable)					
<b>Refrigerant pipe diameter</b>	Gas (swaged)	mm	ø12.7				ø15.88
	Liquid (swaged)	mm	ø6.35				ø9.52
<b>Local drain pipe diameter</b>		D.I. 26 (1) <Accessory pipe O.D. 27 (upper end: O.D. 20)>					
<b>Sound pressure</b> *2**4	dB(A)	34-40		35-40	38-43		40-46

\*1 For heating/cooling capacity, the maximum value with the unit operating in the following conditions is given.  
Cooling: indoor 27°C (81°F) DB/19°C (66°F) WB, outdoor 35°C (95°F) DB. Heating: indoor 20°C (68°F) DB, outdoor 7°C (45°F) DB.

\*2 Air flow/noise levels given for operation in low-high modes.

\*3 Measurement point: 1m x 1m, Power: 240V AC/50Hz:  
1dB(A) less with 230V AC/50Hz.  
2dB(A) less with 220V AC/50Hz.  
3dB(A) less with measurement point at 1.5 m x 1.5 m.

\*4 Measured in anechoic chamber.

# CITY MULTI

## PFFY-P VLRM-E

## PFFY-P VLRMM-E

INDOOR UNIT - BUILT-IN FLOOR UNIT



Built-in floor units: simplified installation for effective air **conditioning performance**.

### VLRM

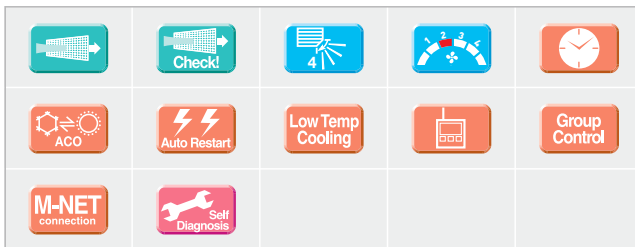

### VLRMM

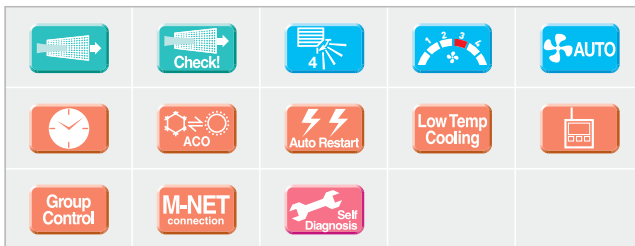

### Compact unit

A compact unit offering a simple solution for conditioning perimeter zones. The compact unit, measuring just 220 mm in depth, is easily installable in perimeter areas to ensure effective conditioning performance even in these zones. The delivery air flow may also be set horizontally.

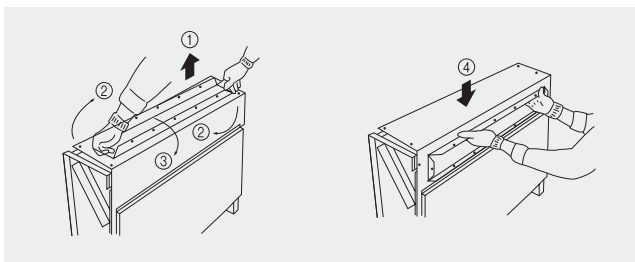

### Selectable static external pressure

The VLRMM series may be configured with a choice of three different static external pressure settings: 20, 40 and 60 Pa.

### Cooling dehumidification function

The electronic dehumidifier function uses cooling to dehumidify the air. Superlative temperature-based dehumidification function to prevent overcooling, for a cooling dehumidification effect.

### Automatic fan speed adjustment

The automatic fan speed adjustment mode – a standard feature on the VLRMM series – ensures fast, comfortable heating as soon as heating mode is activated. Automatic fan speed control is included in the three standard modes “Low”, “Medium” and “High” (two modes available with VLRM series), and ensures faster, comfortable air conditioning by increasing the air flow speed on activation and then reducing speed once stable comfort levels are attained.



## TECHNICAL SPECIFICATIONS

MODEL		PFFY-P20VLRM-E	PFFY-P25VLRM-E	PFFY-P32VLRM-E	PFFY-P40VLRM-E	PFFY-P50VLRM-E	PFFY-P63VLRM-E
<b>Power</b>		A single-phase, 220-240V, 50Hz / a single-phase, 208-230V, 60Hz					
<b>Capacity in cooling mode</b> *1	kW	2.2	2.8	3.6	4.5	5.6	7.1
	Btu/h	7,500	9,600	12,300	15,400	19,100	24,200
<b>Capacity in heating mode</b> *1	kW	2.5	3.2	4.0	5.0	6.3	8.0
	Btu/h	8,500	10,900	13,600	17,100	21,500	27,300
<b>Power consumption</b>	Heating	kW 0.04 / 0.06		0.06 / 0.07	0.065 / 0.075	0.085 / 0.09	0.1 / 0.11
	Cooling	kW 0.04 / 0.06		0.06 / 0.07	0.065 / 0.075	0.085 / 0.09	0.1 / 0.11
<b>Current</b>	Heating	A 0.19 / 0.25		0.29 / 0.30	0.32 / 0.33	0.40 / 0.41	0.46 / 0.47
	Cooling	A 0.19 / 0.25		0.29 / 0.30	0.32 / 0.33	0.40 / 0.41	0.46 / 0.47
<b>External finish (Munsel number)</b>	kg	Acrylic paint (5Y 8/1)					
<b>Dimensions (HxLxW)</b>	mm	639x886x220		639x1,006x220		639x1,246x220	
<b>Net weight</b>	kg	23		25	26	30	32
<b>Heat exchanger</b>		Cross fins (aluminium fins and copper piping)					
<b>Fan</b>	Type x Quantity	Scirocco fan x 1			Scirocco fan x 2		
	Air flow*2	m <sup>3</sup> /min	5.5-6.5	7.0-9.0	9.0-11.0	12.0-14.0	12.0-15.5
		l/s	92-108	117-150	150-183	200-233	200-258
		cfm	194-230	247-318	318-388	424-494	424-547
Static external pres.*2	Pa	0					
<b>Motor</b>	Type	Single-phase induction motor					
	Power output	kW 0.015		0.018	0.030	0.035	0.050
<b>Air filter</b>		Polypropylene honeycomb fabric (washable)					
<b>Refrigerant pipe diameter</b>	Gas (swaged)	mm $\phi$ 12.7					$\phi$ 15.88
	Liquid (swaged)	mm $\phi$ 6.35					$\phi$ 9.52
<b>Local drain pipe diameter</b>		D.I. 26 (1) <Accessory pipe O.D. 27 (upper end: O.D. 20)>					
<b>Sound pressure</b> *2**4	dB(A)	34-40		35-40	38-43		40-46

\*1 For heating/cooling capacity, the maximum value with the unit operating in the following conditions is given.

Cooling: indoor 27°C (81°F) DB/19°C (66°F) WB, outdoor 35°C (95°F) DB. Heating: indoor 20°C (68°F) DB, outdoor 7°C (45°F) DB.

\*2 Air flow/noise levels given for operation in low-high modes.

\*3 Measurement point: 1m x 1m. Power: 240V AC/50Hz,

1dB(A) less with 230V AC/50Hz.

2dB(A) less with 220V AC/50Hz.

3dB(A) less with measurement point at 1.5 m x 1.5 m.

\*4 Measured in anechoic chamber.

## TECHNICAL SPECIFICATIONS

MODEL		PFFY-P20VLRMM-E	PFFY-P25VLRMM-E	PFFY-P32VLRMM-E	PFFY-P40VLRMM-E	PFFY-P50VLRMM-E	PFFY-P63VLRMM-E
<b>Power</b>		A single-phase, 220-240V, 50Hz / a single-phase, 220-240V, 60Hz					
<b>Capacity in cooling mode</b> *1	kW	2.2	2.8	3.6	4.5	5.6	7.1
	Btu/h	7,500	9,600	12,300	15,400	19,100	24,200
<b>Capacity in heating mode</b> *1	kW	2.5	3.2	4.0	5.0	6.3	8.0
	Btu/h	8,500	10,900	13,600	17,100	21,500	27,300
<b>Power consumption</b>	Heating	kW 0.04		0.04	0.05	0.05	0.07
	Cooling	kW 0.04		0.04	0.05	0.05	0.07
<b>Current</b>	Heating	A 0.34		0.38	0.43	0.48	0.59
	Cooling	A 0.34		0.38	0.43	0.48	0.59
<b>External finish (Munsel number)</b>	kg	Galvanised steel sheet					
<b>Dimensions (HxLxW)</b>	mm	639x886x220		639x1,006x220		639x1,246x220	
<b>Net weight</b>	kg	18.5		20	21	25	27
<b>Heat exchanger</b>		Cross fins (aluminium fins and copper piping)					
<b>Fan</b>	Type x Quantity	Scirocco fan x 1			Scirocco fan x 2		
	Air flow (low-medium-high)	m <sup>3</sup> /min	4.5-5.5-6.5	6.5-7.5-9.0	8.0-9.5-11.0	10.0-12.0-14.0	11.0-13.0-15.5
		l/s	75-92-108	108-125-150	133-158-183	167-200-233	183-217-258
		cfm	159-194-230	230-265-318	282-335-388	353-424-494	388-459-547
Static external pres.*2	Pa	20/40/60					
<b>Motor</b>	Type	Brushless DC Motor					
	Power output	kW 0.096					
<b>Air filter</b>		Polypropylene honeycomb fabric (washable)					
<b>Refrigerant pipe diameter</b>	Gas (swaged)	mm $\phi$ 12.7, brazed					$\phi$ 15.88, brazed
	Liquid (swaged)	mm $\phi$ 6.35, brazed					$\phi$ 9.52, brazed
<b>Local drain pipe diameter</b>		D.I. 26 (1) <Accessory pipe O.D. 27 (upper end: O.D. 20)>					
<b>Sound pressure (low-medium-high)</b> *3	20Pa	dB(A) 31-36-40	27-32-37	30-36-40	32-37-41	35-40-44	
	40Pa	dB(A) 34-39-42	30-35-41	32-38-42	35-40-44	36-42-47	
	60Pa	dB(A) 35-40-43	32-37-42	3.5-39-44	36-41-45	38-43-48	

\*1 For heating/cooling capacity, the maximum value with the unit operating in the following conditions is given.

Cooling: indoor 27°C (81°F) DB/19°C (66°F) WB, outdoor 35°C (95°F) DB. Heating: indoor 20°C (68°F) DB, outdoor 7°C (45°F) DB/6°C (43°F) WB.

\*2 Static external pressure is set to 20 Pa by default.

\*3 Operating noise level measured at a distance of 1m from front side and from rear side in an anechoic chamber (sound pressure meter, A scale). Connect the 1m long duct to the air outlet.

CITY MULTI

# VRF HP DXE (exposed)

# VRF HP R DXE (recessed)

INDOOR UNIT – AIR CURTAINS



VRF HP DXE



VRF HP R DXE

The air curtain, is the ideal solution for creating a barrier effect between an indoor space and the outdoor environment. Placed in the ideal position over the doorway, the curtain stops polluted outdoor air from entering, maintaining a healthy and comfortable environment in the indoor space.

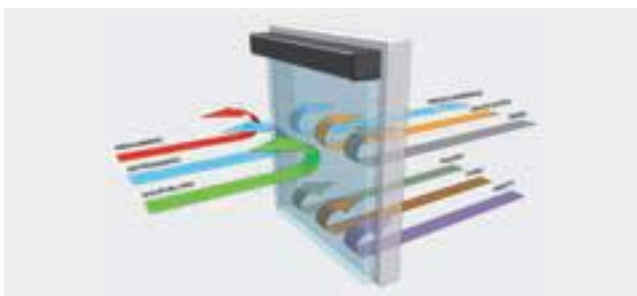
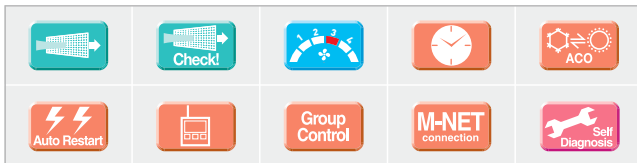

### 3 speed fan

The PAR-30MAA, PAR-21MAA or PAR- F27MEA remote controls may be used to select from a choice of 3 different fans speeds (selected from an initial choice of 6 during initial installation).

The air curtain is an indoor unit which keeps out dust, exhaust fumes, smoke, unpleasant odours and insects (such as flies and mosquitoes) without impeding access. The unit protects the indoor environment while letting customers come and go freely. The air curtain is invisible, and makes it extremely simple to bring in and handle stock and goods on the premises.

### Uniform delivery air

Tested in accordance with ISO 27327 standards, VRF air curtains by Mitsubishi Electric offer class-beating delivery air uniformity levels (92%).

### EcoPower Air technology

VRF air curtains feature EcoPower Air technology, which increases air flow speed and uniformity and maximises the energy efficiency of the unit. EcoPower Air technology employs a specifically designed air plenum, a converging delivery nozzle and an active cellular air outlet grille to ensure a more effective barrier action and increase performance.

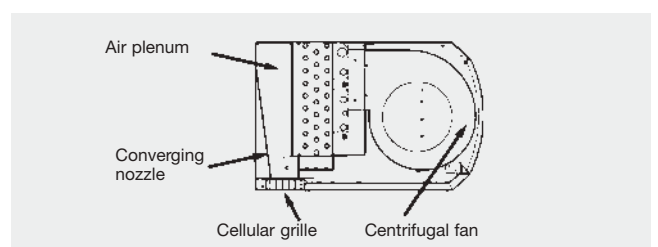

## Correct installation

When choosing an air curtain, it is very important to ensure that the air barrier is wider than the door it protects and is not installed at a height of more than 3.8 m. These requisites must be met for the barrier to function effectively.

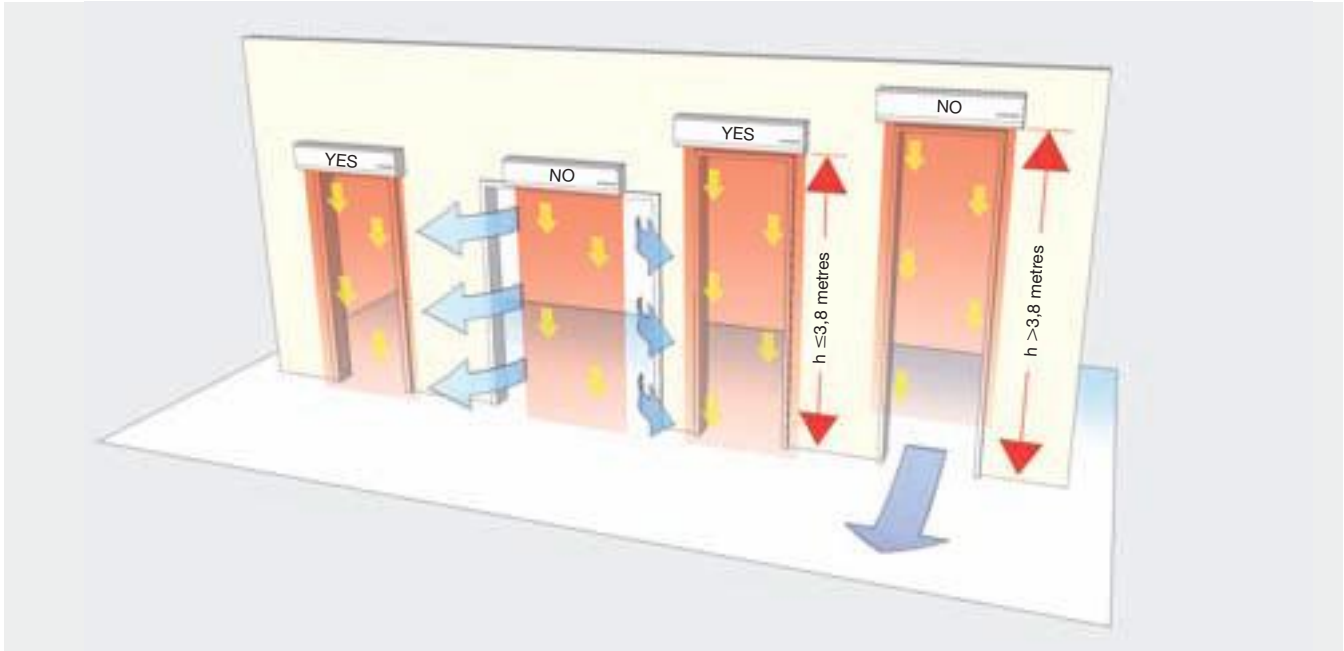

## TECHNICAL SPECIFICATIONS

EXTERNAL MODEL		VRF HP1000 DXE	VRF HP1500 DXE	VRF HP2000 DXE	
<b>Power*1</b>		A single-phase, 220-240V AC, 50Hz			
<b>Capacity in heating mode *2</b>	kW	8,3	13,2	15,7	
<b>Capacity in cooling mode *2</b>	kW	7,4	11,8	14,0	
<b>Power index</b>		P71	P125	P140	
<b>Current</b>	A	0,8 (7,3)*3	1,2 (12,1)*3	1,4 (14,1)*3	
<b>Door width</b>	mm	1000	1500	2000	
<b>Maximum door height</b>	Sheltered installation*4	mm	3800	3800	
	Exposed installation*4	mm	3300	3300	
<b>Maximum air speed*5</b>	m/s	-9	-9	-9	
<b>Dimensions (HxLxW)</b>		306x1300x468		306x2350x468	
<b>Net weight</b>	kg	46	67	84	
<b>Fan</b>	Air flow	m <sup>3</sup> /min	16,1-19,5-21,8	24,2-30,0-34,5	29,8-35,7-39,3
	Static external pres.	Pa	0	0	0
<b>Uniformity of delivery air</b>	ISO 27327	%	90	92	90
<b>Sound pressure</b>	dB(A)	50-55-58	49-54-58	50-55-58	

BUILT-IN MODEL		VRF HP1000 R DXE	VRF HP1500 R DXE	VRF HP2000 R DXE	
<b>Power*1</b>		A single-phase, 220-240V AC, 50Hz			
<b>Capacity in heating mode *2</b>	kW	8,3	13,2	15,7	
<b>Capacity in cooling mode *2</b>	kW	7,4	11,8	14,0	
<b>Power index</b>		P71	P125	P140	
<b>Current</b>	A	0,8 (7,3)*3	1,2 (12,1)*3	1,4 (14,1)*3	
<b>Door width</b>	mm	1000	1500	2000	
<b>Maximum door height</b>	Sheltered installation*4	mm	3800	3800	
	Exposed installation*4	mm	3300	3300	
<b>Maximum air speed*5</b>	m/s	-9	-9	-9	
<b>Dimensions (HxLxW)</b>		354x1250x485		354x2340x485	
<b>Net weight</b>	kg	46	67	84	
<b>Fan</b>	Air flow	m <sup>3</sup> /min	16,1-19,5-21,8	24,2-30,0-34,5	29,8-35,7-39,3
	Static external pres.	Pa	0	0	0
<b>Uniformity of delivery air</b>	ISO 27327	%	90	92	90
<b>Sound pressure</b>	dB(A)	50-55-58	49-54-58	50-55-58	

\*1 If the barrier is equipped with an electrical heating element (which, if enabled, only operates during outdoor unit defrost cycle), the element requires a separate, specific 380-415V AC, 50Hz three-phase power supply.

\*2 In the following nominal conditions for heating mode: indoor 20°C DB, outdoor 7°C DB/6°C WB. In the following nominal conditions for cooling mode: indoor 20°C DB, outdoor 35°C DB/27°C WB.

\*3 Value in brackets indicates current absorption during activation of electrical heating element, if connected (during outdoor unit heating cycle)

\*4 'Sheltered location' indicates an air barrier protecting a door that does not open directly onto the outdoor environment and which is itself protected by an outer door. 'Exposed installation' indicates an air barrier protecting a door that opens directly onto the outdoor environment.

\*5 At air delivery outlet at maximum fan speed.

# CITY MULTI

## Ventilation serie

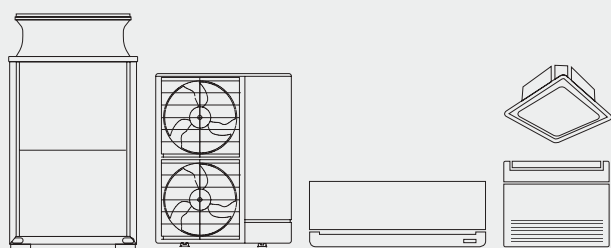



















 **MITSUBISHI  
ELECTRIC**  
LIVING ENVIRONMENTAL SYSTEMS

---

## INDEX

	PEFY-P VMH-E-F.....	164
	LGH-RVX.....	166
	LGF-100GX-E.....	170
	GUF-RDH4 .....	174
	.....	178

TYPE	MODEL NAME	MODEL	Air flow (mc/h)			
			500	650	800	1000
<b>All fresh air (AFA)</b>	PEFY-P80VMH-E-F					
	PEFY-P140VMH-E-F					
	PEFY-P200VMH-E-F					
	PEFY-P250VMH-E-F					
<b>Lossnay Enthalpy heat recovery (LGH)</b> <span style="color: red; font-weight: bold; border: 1px solid red; border-radius: 50%; padding: 2px;">NEW</span>	LGH-50RVX-E					
	LGH-65RVX-E					
	LGH-80RVX-E					
	LGH-100RVX-E					
	LGH-150RVX-E					
	LGH-200RVX-E					
<b>Floor standing Lossnay (LGF)</b>	LGF-100GX-E					
<b>Outdoor air treatment indoor units (GUF)</b>	GUF-50RDH4					
	GUF-100RDH4					
<b>Outdoor air treatment machines</b>  	FAU-AE(S)5000					
	FAU-AE(S)7500					
	FAU-AE(S)10000					
	FAU-AE(S)12500					
	FAU-AE(S)15000					

1500

2000

5000

7500

10000

12500

1500



# CITY MULTI PEFY-P VMH-E-F



## OUTDOOR FRESH AIR DELIVERY UNIT

For feeding temperature-controlled fresh outdoor air into the building.

The ideal solution for offices, large stores and restaurants.



### Install anywhere

The indoor purified air delivery unit may be installed anywhere. The purified air delivery unit may be used to feed fresh, purified outdoor air into any building, in any place and at any time.

**OFFICE, FOYER, LABORATORY,  
REST ROOM, HEALTHCARE CLINIC,  
SMOKING AREA, RESTAURANT KITCHEN**

INSTALLATION OF  
INDOOR FRESH  
OUTDOOR AIR  
TREATMENT UNIT

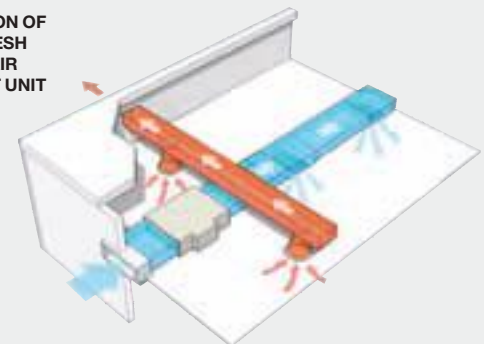

### Capacity limits for connection to outdoor unit

Max. 110% of capacity of outdoor unit, except in case of heating mode at outdoor temperatures below  $-5^{\circ}\text{C}$  ( $23^{\circ}\text{F}$ ), where a limit of 100% applies.

#### EXAMPLE

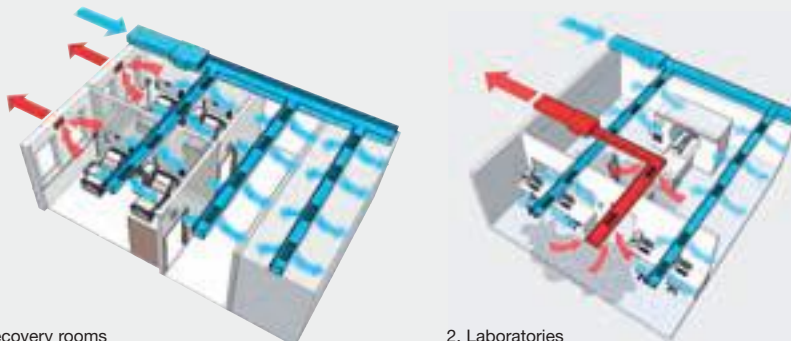

1. Hospital recovery rooms

2. Laboratories

Note: The fan keeps running even when the thermostat is off. We recommend using this model with other indoor unit models to prevent cold draughts of incoming outdoor air.



## TECHNICAL SPECIFICATIONS

MODEL			PEFY-P80VMH-E-F	PEFY-P140VMH-E-F	PEFY-P200VMH-E-F	PEFY-P250 VMH-E-F
<b>Power</b>			A single-phase, 220-240V 50Hz/ A single-phase 208-230V 60Hz		3N – 380-415V 50 Hz / 3N – 380-415V 60 Hz	
<b>Capacity in cooling mode</b> *1		kW	9.0	16.0	22.4	28.0
		Btu/h	30,700	54,600	76,400	95,500
<b>Capacity in cooling mode</b> *1		kW	8.5	15.1	21.2	26.5
		Btu/h	29,000	51,500	72,300	90,400
<b>Power consumption</b>	Cooling mode	kW	0.16 / 0.21	0.29 / 0.33	0.34 / 0.42	0.39 / 0.50
	Cooling	kW	0.16 / 0.21	0.29 / 0.33	0.34 / 0.42	0.39 / 0.50
<b>Current</b>	Cooling mode	A	0.67 / 0.91	1.24 / 1.48	0.58 / 0.74	0.68 / 0.86
	Cooling	A	0.67 / 0.91	1.24 / 1.48	0.58 / 0.74	0.68 / 0.86
<b>External finish</b>		kg	Galvanised		Galvanised	
<b>Dimensions (HxLxW)</b>		mm	380x1000x900	380x1200x900	470x1250x1120	
<b>Net weight</b>		kg	50	70	100	
<b>Heat exchanger</b>			Cross fins (aluminium fins and copper piping)		Cross fins (aluminium fins and copper piping)	
<b>Fan</b>	Type x Quantity		Scirocco fan x 1	Scirocco fan x 2	Scirocco fan x 2	
	Air flow *2	m <sup>3</sup> /min	9.0	18.0	28	35
		l/s	150	300	467	583
		cfm	18	636	989	1236
	Static external pressure (low-medium-high)	208V Pa	35 - 85 - 170	35 - 85 - 170	-	
		220V Pa	40 - 115 - 190	50 - 115 - 190	-	
		230V Pa	50 - 130 - 210	60 - 130 - 220	-	
		240V Pa	80 - 170 - 220	100 - 170 - 240	-	
	Static external pressure	380V Pa	-	-	140 / 200	110 / 190
		400V Pa	-	-	150 / 210	120 / 200
415V Pa		-	-	160 / 220	130 / 210	
<b>Motor</b>	Type		Single-phase induction motor		Three-phase induction motor	
	Power output	kW	0.09 (a 220V)	0.14 (a 220V)	0.20	0.23
<b>Air filter</b>			Coated non-woven synthetic fibre filter (long life)		Coated non-woven synthetic fibre filter (long life)	
<b>Refrigerant pipe diameter</b>	Gas (swaged)	mm	ø15.88		ø19.05	ø22.2
	Liquid (swaged)	mm	ø9.52		ø9.52	
<b>Local drain pipe diameter</b>			O.D.32		O.D.32	
<b>Sound pressure (low-medium-high)</b> *2	208, 220V	dB(A)	27 - 38 - 43	28 - 38 - 43	-	
	230, 240V	dB(A)	33 - 43 - 45	34 - 43 - 45	-	
<b>Sound pressure</b> *2	380V	dB(A)	-	-	39 / 42	40 / 44
	400V	dB(A)	-	-	40 / 43	40 / 45
	415V	dB(A)	-	-	40 / 44	41 / 46

\*1 The cooling and heating capacities indicated above are the maximum capacities measured in the air conditions described above and with a refrigerant pipe approximately 7.5 m in length.

\*2 Actual capacity characteristics vary in relation to the combination of indoor and outdoor units used. See technical information.

- The operating noise levels indicated are the sound pressure values measured at 1.5 m from the base of the unit in an anechoic chamber. (sound pressure meter, A scale value)
- Value given is for operation with 240V 50 Hz/230V 60 Hz electrical power (PEFY-P80, type 140VMH-E-F).
- When connecting purified fresh air delivery indoor units in a system, the maximum quantity of indoor units connected to an outdoor unit varies as follows:

Heat pump models	Cooling only
110% (100% in case of heating operation at outdoor temperatures below -5°C (23°F))	110%

- Operating temperature range:  
Cooling: from 21°C (70°F) DB/15.5°C (60°F) WB to 43°C (109°F) DB/35°C (95°F) WB.  
Heating: from -10°C (14°F) DB to 20°C (68°F) DB.  
\* The fan is activated automatically with the thermostat off at temperatures below 21°C (70°F) DB in cooling mode, and at temperatures above 20°C (68°F) DB in heating mode.
- As the ambient temperature is measured by a thermostat on the remote controller or installed

inside the room, ensure that a remote controller or thermostat is used within the room itself.

- The automatic conversion and dehumidifying functions are NOT available. The unit functions in fan mode when the thermostat is off in cooling or heating mode.
- In all situations, the air flow must be kept below 110%, as shown in the table above. See "Fan curves" for more details.
- When this unit is used as the sole air conditioning system, note that condensation may form on the air outlet vent grilles of the outdoor unit when in cooling mode.
- Untreated outdoor air, which may be humid or cold, will enter the indoor space when the unit is operating with the thermostat off. Choose the location of the indoor unit air outlets carefully, taking all possible precautions to prevent the entry of cold air and to insulate the room adequately to prevent condensation.
- The air filter must be installed on the air intake side. When using a third party or existing filter, it must be installed in an easily accessible location to permit maintenance.
- The long life model cannot be used together with the high filtration efficiency filter (PEFY-P80, type 140VMH-E-F).

# LGH-RVX



## LOSSNAY – Heat recovery ventilation units

### The importance of adequate air exchange

Air quality is a primary parameter for comfort. Poor air quality in the office or at home has been proven to have a significantly detrimental influence on productivity and on the healthiness of the environment, and contribute to fatigue. This is due to increasing concentrations of CO<sub>2</sub> caused by inadequate air exchange. To live comfortably, **every individual needs 400l of fresh air per hour.** Ensuring **adequate ventilation** in residential and commercial buildings is necessary **to offer a healthy, comfortable environment for all occupants.**

### The importance of correctly controlled humidity

A **dry environment** offers the ideal conditions for the proliferation of **bacteria and viruses**, and the survival rate of these micro-organisms drops rapidly at relative humidity levels above 50%. **Excessively humid environments**, on the other hand, encourage the proliferation of **mould and mites**. Precise humidity control is therefore an important factor in maintaining ideal, healthy conditions.

### OXYGEN CONCENTRATIONS AND THE EFFECTS OF INADEQUATE OXYGEN LEVELS

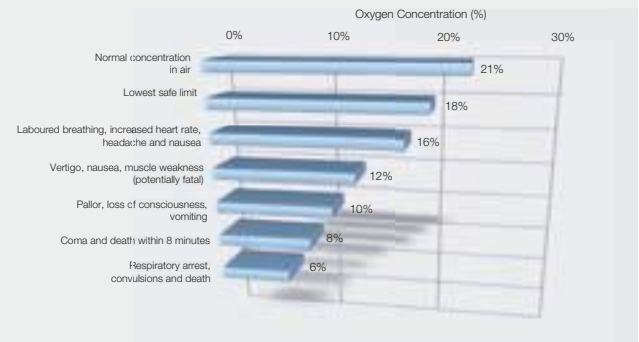

### ACTIVITY OF MICRO-ORGANISMS IN RELATION TO HUMIDITY

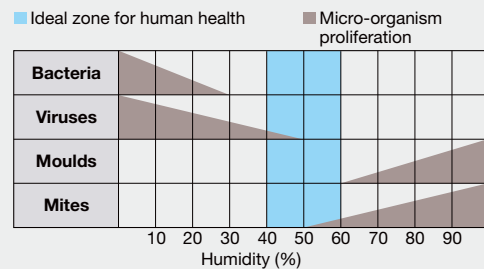

Source: ASHRAE Trans. 91 - 1B (1985)

## Simple construction

As shown in the figure, the Lossnay exchanger consists of a structure in special treated paper allowing two different air flows to cross one another and exchange thermal energy. Partitions separating the inlet and outlet channels prevent incoming fresh air from ever mixing with outgoing air.

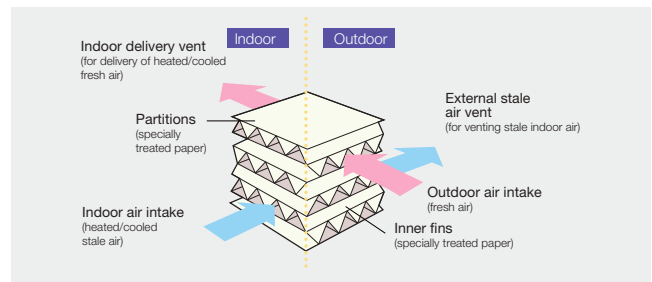

## Operating principle

The Lossnay exchanger performs a highly effective total exchange action for both temperature (sensible heat) and humidity (latent heat) – the system uses moisture permeable partitions in specially treated paper to allow stale air to be vented externally and fresh outdoor air to be fed to the indoor space with absolutely no mixing between the two air flows.

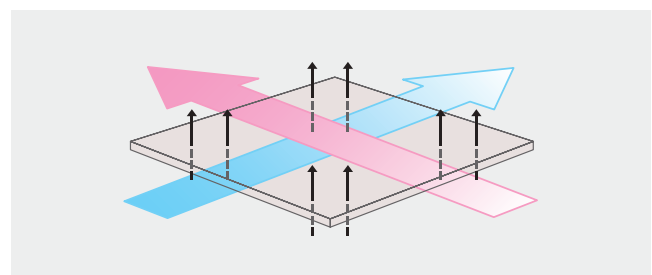

## Energy recovery

### Comfort and energy savings

With universally recognised efficiency, Lossnay heat exchanger ventilation units use energy recovery to offer significant energy savings.

A conventional ventilation system vents treated indoor air into the outdoor environment and replaces this air with outdoor air, causing the room to lose heat in winter and heat up in summer. This loss of heated/cooled air means that energy must be expended to restore comfortable temperature conditions in the indoor space. The result of this is notably higher air conditioning costs. To solve this problem while still ensuring the necessary air exchange, Mitsubishi Electric offers a range of thermal energy recovery ventilation systems, which minimise air conditioning costs.

All Lossnay units are equipped with class "G3" air filter. LGH models may also be equipped with a class "F7" high efficiency filter.

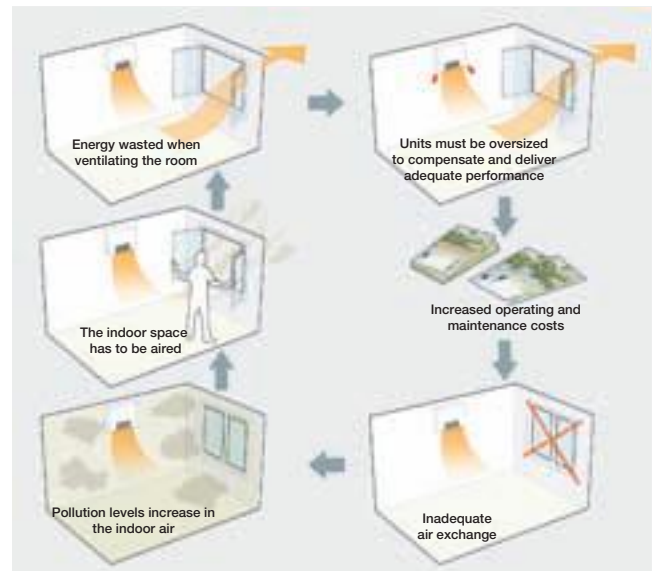

## Comfortable air exchange action, in either cold or hot outdoor conditions

**Summer** - Difference in temperature between new fresh air and air already in room of only 1.7°C.

- Incoming fresh air is brought to the same conditions as the cooled (and dehumidified) air in the room.

**Winter** - 4 kg/h humidity recovered

- Incoming fresh air is brought to the same conditions as the warmed (and humidified) air in the room.

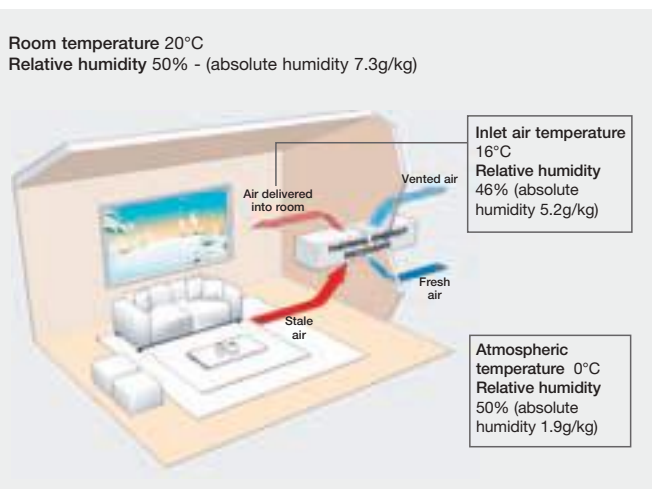
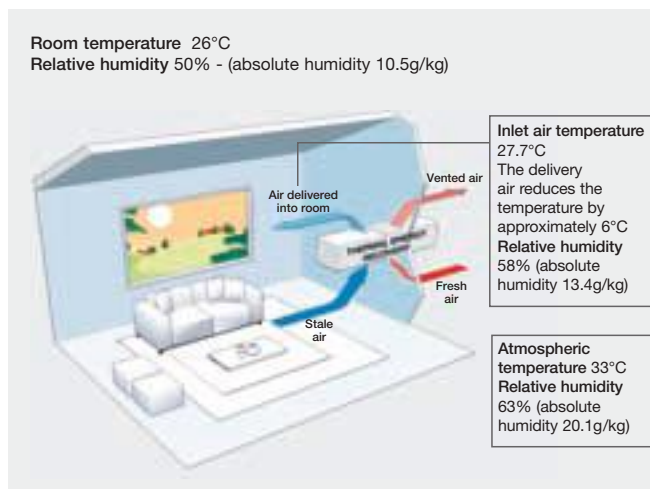

## Low noise

Precise control over the flow of treated air significantly reduces the sound pressure values of the LOSSNAY unit by up to 18 dB(A). All LGH-RVX units ensure ideal acoustic comfort, including for residential applications, libraries, offices etc.



## Weekly timer

In addition to the precise air flow control of the new LGH-RVX units, a weekly timer function also increases energy savings.



# LGH-RVX

## LOSSNAY for energy savings

### New DC FAN Motor

The new **DC motor** used throughout the new LGH-RVX series offers a number of advantages:

- **Very low electric power consumption**, especially at low speeds
- Lower noise emissions
- Increased flexibility and fine air flow adjustment from remote control.

### Bypass shutter

The LGH-RVX series is equipped with a bypass shutter:

When the shutter is open, fresh air is fed to the interior space with no heat recovery, passing through the filter only.

The bypass shutter may be activated manually from the remote control, or automatically in specific thermal conditions (Free-Cooling).

**ELECTRICAL POWER CONSUMPTION, LGH-50\***



\* Electrical power absorption of LGH-RVX and LGH-RX5 models at different speeds with 50 version recovery module.

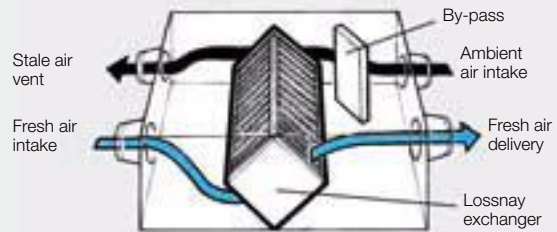

EXAMPLE OF BYPASS FUNCTION IN FREE-COOLING MODE

## New PZ-61DR-E dedicated remote control

The new wired remote control unit specifically for LGH-RVX heat recovery units boasts a fresh new look and new features.

- Possibility of managing a group of up to 15 units
- Simple and intuitive
- Backlit LCD screen
- Internal weekly timer
- Custom ventilation strategies for mode switching (Auto/recovery/bypass)
- Night purge function for active night-time ventilation in summer.

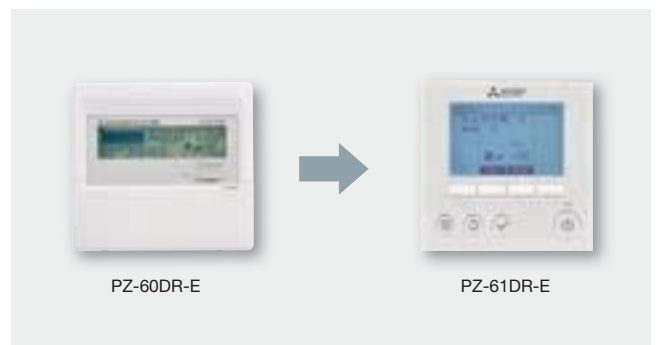

## Compliant with ErP Directive, Lot 11

EU Regulation 327/2011, effective from 1 January 2015, implements the conditions specified in Directive ErP 2009/125 to encourage the design and manufacture of environmentally compatible energy consuming products with the goal of reducing CO<sub>2</sub> emissions and energy consumption by 20% by 2020.

All fans and ventilation units with electric motors with a rated power absorption between 125 W and 500 W fall within the scope of application of this regulation. The Mitsubishi Electric LGH-RVX-E Lossnay enthalpic recovery unit is compliant with this directive.

The European Union has set a series of very challenging environmental targets which must be attained by 2020. These targets are grouped together and described with the general title "20/20/20 Package", indicating an increase of 20% in the use of renewable energy sources over 1990 together with a reduction of 20% in primary energy source consumption and CO<sub>2</sub> emissions.

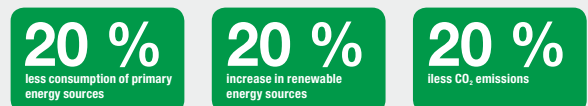

## TECHNICAL SPECIFICATIONS

MODEL		LGH-50RVX-E				LGH-65RVX-E			
<b>Speed</b>		Extra High	High	Low	Extra Low	Extra High	High	Low	Extra Low
<b>Treated air volume</b>	m <sup>3</sup> /h	500	375	250	125	650	488	325	163
<b>Static pressure</b>	Pa	120	68	30	8	120	68	30	8
<b>Sensible heat exchange efficiency</b>	%	78,0	81,0	83,5	87,0	77,0	81,0	84,0	86,0
<b>Enthalpic exchange efficiency</b>	Heating	66,5	68,0	72,5	82,0	66,0	69,5	74,0	81,0
	Cooling	69,0	71,0	75,0	82,5	68,5	71,0	76,0	82,0
<b>Sound pressure</b>	dB(A)	34-35	28-29	19-20	18	34,5-35,5	29	22	18
<b>Weight</b>	kg	33				38			
<b>Power</b>	V/Fase/Hz	220-240 / Single-phase /50							
<b>Power absorption</b>	W	165-173	78-81	32-35	12-14	252-262	131	49-47	15-17
<b>No. and diameter of channels</b>	mm	4 x 200				4 x 200			
<b>Dimensions</b>	HxLxW	331x1016x888				404x954x908			
	mm								
<b>Operating temperature range guaranteed</b> <small>(Continuous operation range)*</small>	Outd. Temp.	-10 ~ +40				-10 ~ +40			
	Max. outd. RH	80				80			
	Max. ind. Temp	40				40			
	Max. ind. RH	80				80			

MODEL		LGH-80RVX-E				LGH-100RVX-E			
<b>Speed</b>		Extra High	High	Low	Extra Low	Extra High	High	Low	Extra Low
<b>Treated air volume</b>	m <sup>3</sup> /h	800	600	400	200	1000	750	500	250
<b>Static pressure</b>	Pa	150	85	37,5	10	170	95,6	42,5	10,6
<b>Sensible heat exchange efficiency</b>	%	79,0	82,5	84,0	85,0	80,0	83,0	86,5	89,5
<b>Enthalpic exchange efficiency</b>	Heating	70,0	72,5	78,0	81,0	71,0	73,0	77,0	85,5
	Cooling	71,0	73,5	78,0	81,0	72,5	74,0	78,0	87,0
<b>Sound pressure</b>	dB(A)	34,5-36,0	30,0	23	18	37-38	31-32	23-24	18
<b>Weight</b>	kg	48				54			
<b>Power</b>	V/Fase/Hz	220-240 / Single-phase /50							
<b>Power absorption</b>	W	335-340	151	60-64	18-20	420	200	75	21
<b>No. and diameter of channels</b>	mm	4 x 250				4 x 250			
<b>Dimensions</b>	HxLxW	404x1004x1144				404x1231x1144			
	mm								
<b>Operating temperature range guaranteed</b> <small>(Continuous operation range)*</small>	Outd. Temp.	-10 ~ +40				-10 ~ +40			
	Max. outd. RH	80				80			
	Max. ind. Temp	40				40			
	Max. ind. RH	80				80			

MODEL		LGH-150RVX-E				LGH-200RVX-E			
<b>Speed</b>		Extra High	High	Low	Extra Low	Extra High	High	Low	Extra Low
<b>Treated air volume</b>	m <sup>3</sup> /h	1500	1125	750	375	2000	1500	1000	500
<b>Static pressure</b>	Pa	175	98,4	43,8	10,9	150	84,4	37,5	9,5
<b>Sensible heat exchange efficiency</b>	%	80,0	82,5	84,0	85,0	80,0	83,0	86,5	89,5
<b>Enthalpic exchange efficiency</b>	Heating	70,5	72,5	78,0	81,0	71,0	73,0	77,0	85,5
	Cooling	72,0	73,5	78,0	81,0	72,5	74,0	78,0	87,0
<b>Sound pressure</b>	dB(A)	39,0-40,5	32-33	24-26	18	40-41	36	28-27	18-19
<b>Weight</b>	kg	98				110			
<b>Power</b>	V/Fase/Hz	220-240 / Single-phase /50							
<b>Power absorption</b>	W	670-698	311	123-124	38-44	850-853	400-372	153-150	42-49
<b>No. and diameter of channels</b>	mm	8 x 250				8 x 250			
<b>Dimensions</b>	HxLxW	808x1004x1144				808x1231x1144			
	mm								
<b>Operating temperature range guaranteed</b> <small>(Continuous operation range)*</small>	Outd. Temp.	-10 ~ +40				-10 ~ +40			
	Max. outd. RH	80				80			
	Max. ind. Temp	40				40			
	Max. ind. RH	80				80			

\*At temperatures <10°C, the fan functions intermittently. In these conditions, we recommend using a heater unit that may be controlled by the LOSSNAY unit

# LGF-100GX-E



The new Mitsubishi Electric LGF-100GX-E Lossnay enthalpic heat recovery unit for basement installations delivers up to 1000 m<sup>3</sup>/h of fresh air and offers extraordinary installation and operational flexibility, complying with the most stringent air hygiene standards and with the latest regulations regarding air exchange in non-residential environments.



## Easy installation and maintenance

The LGF-100GX-E is installed in a dedicated service area in the basement, allowing inspection without disturbing the occupants of the treated indoor space and eliminating undesirable noise. All air passage sections are easily accessible for maintenance and cleaning by simply removing all the main components and partition trays. This, combined with the potent filtration capacity, has made

it possible to attain German VDI (Verein Deutscher Ingenieure) 6022 certification – one of the most stringent qualifications for industrial hygiene.



Hygiene-Institut des Ruhrgebiets



LGF-100GX-E – Front view



Removing front panels



Removing filters and Lossnay recovery module



Cleaning partitions



Cleaning partitions



Removing ventilation section

## Lossnay technology

The Lossnay total heat recovery module has a cross-flow plate fin structure and heat transfer diaphragms in special treated paper. The excellent thermal transfer properties and permeability to moisture of this special paper ensure the highly efficient **exchange of both sensible and latent heat** between the two air flows passing through the recovery core. The result is a ventilation system with outstanding characteristics ensuring extremely high levels of comfort and wellbeing in the environment treated, which can also cut operating costs substantially.

The diaphragm pores, which were already microscopic in previous generations, have been further reduced in size to reduce the

possibility of the passage of waterborne soluble gases such as ammonia and hydrogen from the exhausted stale air to the fresh air delivered to the indoor space.

To increase heat and moisture exchange, a special treatment is applied to the paper used for the diaphragms.

These improvements have increased moisture permeability while reducing permeability to harmful gases, resulting in an overall increase in recovery efficiency and a more effective barrier action against the transfer of these gases.

### CONSTRUCTION AND OPERATING PRINCIPLE OF LOSSNAY UNIT

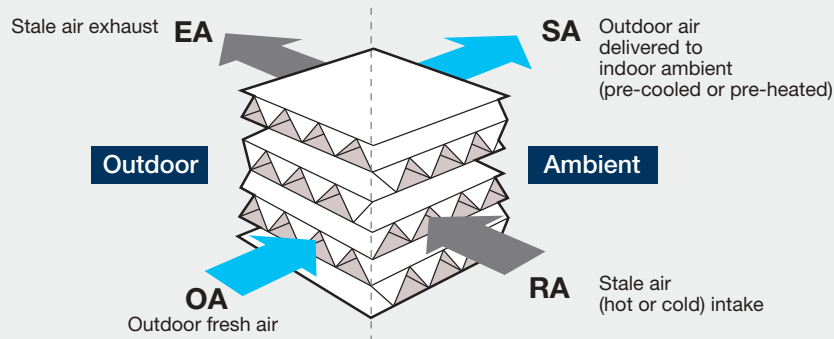

## Superior performance

Increased energy savings due to greater thermal exchange efficiency

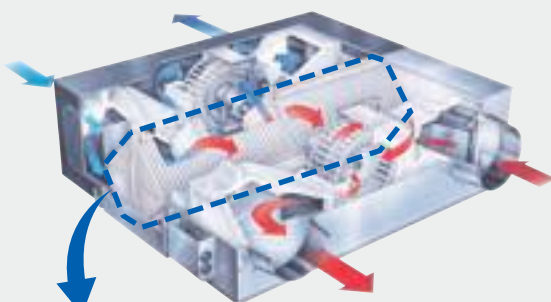

### HYPER ECO ELEMENT

The Mitsubishi Electric enthalpic heat recovery unit offers unparalleled thermal exchange efficiency. The significant energy savings offered are due to the extraordinarily efficient latent and sensible heat recovery.

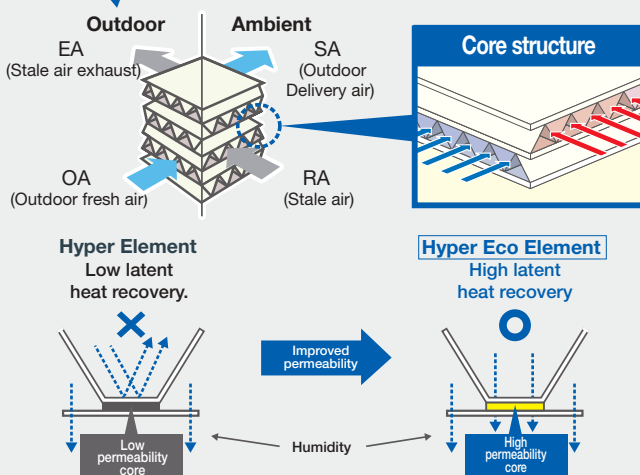

### Improved efficiency with RX5 technology

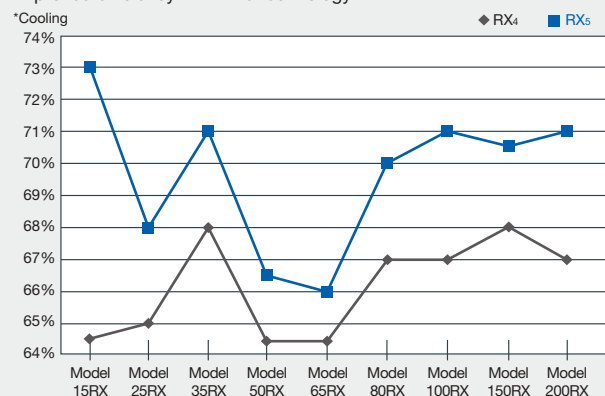

# LGF-100GX-E

## Total management

The LGF-100GX Lossnay unit may be managed from the dedicated PZ-60DR-E remote controller, which lets the user control a number of different parameters, choose between 3 operating modes (Heat recovery, Bypass and Automatic), and offers access to numerous functions devised for maximum comfort and energy savings (daily and weekly timer, night purge function). The LGF-100GX Lossnay unit may also be integrated into the architecture of a Mitsubishi Electric VRF CITY MULTI system, interlocked with the VRF indoor units of the system.

## Bypass shutter

The bypass shutter diverts the inlet air flow from the indoor space directly to the outdoor vent and allows suitably filtered fresh outdoor air directly into the indoor space.

In addition to operation in automatic or manual mode, the bypass may also be operated remotely via an external contact, controlled in turn by a temperature sensor, a hygrometer sensor or a timer.

## Night Purge function

The bypass shutter is also used to implement the “Night Purge” energy saving function. This function is activated at night-time in summer, and uses the free thermal power of the cooler outdoor air to reduce the thermal load of the indoor space.

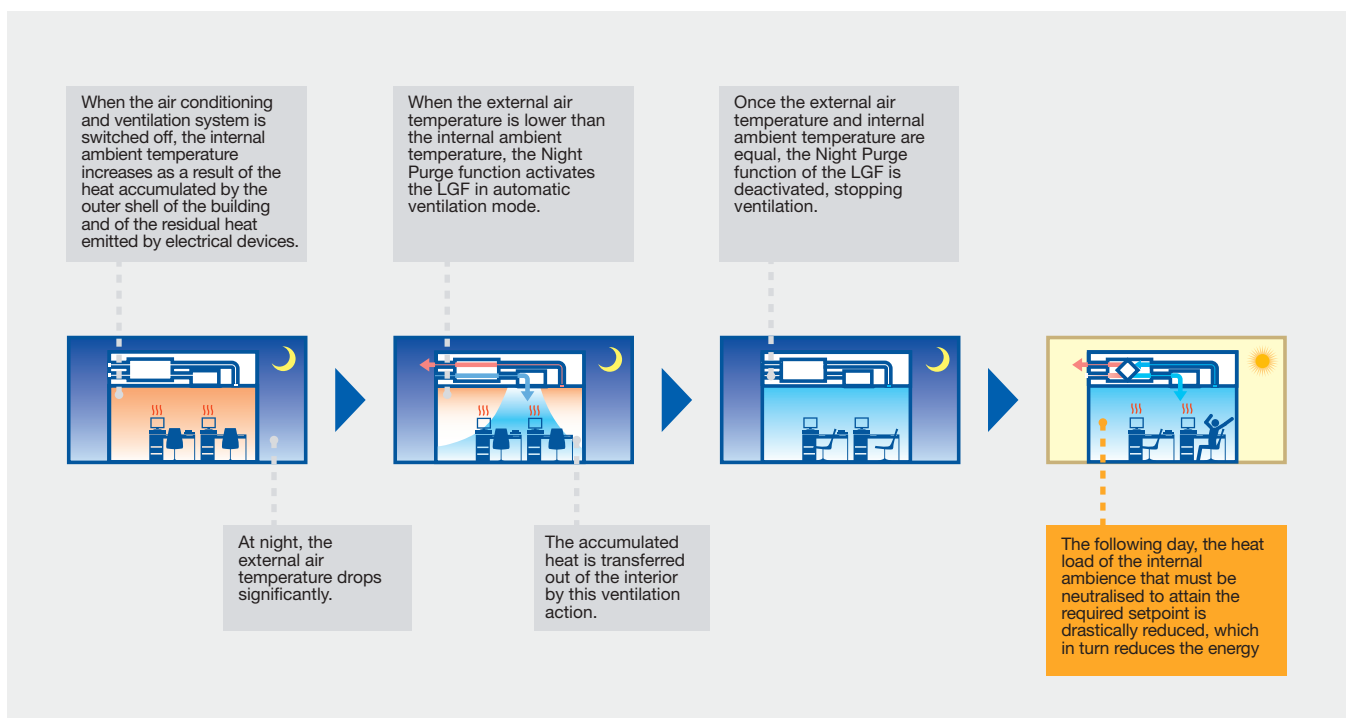



## “Multi-Ventilation” Mode

The PZ-60DR remote control unit may be used to select 9 different delivery air and intake air fan speed combinations to cater for different needs and ambient thermal loads.

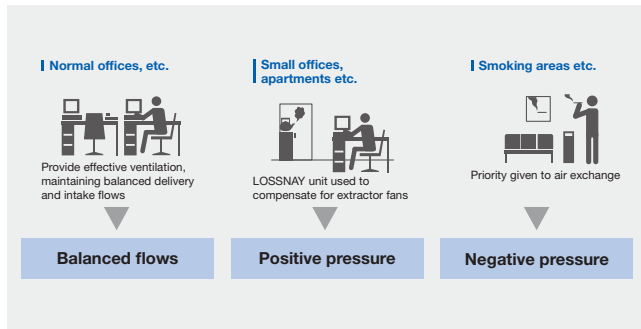

MULTI-VENTILATION MODE	DELIVERY AIR	INTAKE AIR
Balanced flows	Extra High	Extra High
	High	High
Energy saving ventilation	Low	Low
Positive pressure	Extra High	High
	High	Low
Negative pressure	High	Extra High
	Low	Extra High
	Low	High

Note: the default setting is with balanced flows in High / High configuration.

## High effective static pressure

Selecting the “Extra high” fan speed setting makes it possible to produce effective static pressure values up to **200 Pa** for applications requiring long air duct lengths.

## High Performance Filtration

Equipped with two high efficiency **F7** filters – with one installed on the outdoor intake and one on the indoor air intake – the LGF-100GX-E may be used in all the building types specified in the latest regulations concerning ventilation and air exchange.

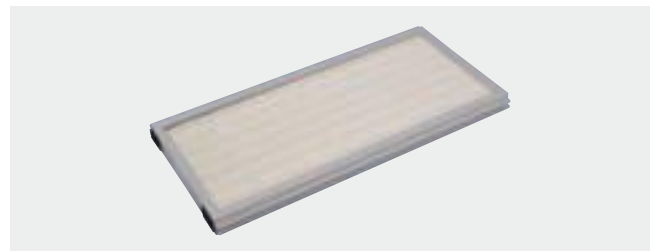

## Compliant with ErP Directive, Lot 11

EU Regulation 327/2011, effective from 01.01.15, implements the conditions specified in Directive ErP 2009/125 to encourage the design and manufacture of environmentally compatible energy consuming products with the goal of reducing CO<sub>2</sub> emissions and energy consumption by 20% by 2020.

All fans and ventilation units with electric motors with a rated power absorption **between 125 W and 500 W** fall within the scope of application of this regulation. The Mitsubishi Electric **LGF-100GX-E** Lossnay enthalpic recovery unit is compliant with this directive.

The European Union has set a series of very challenging environmental targets which must be attained by 2020. These targets are grouped together and described with the general title “20/20/20 Package”, indicating an increase of 20% in the use of renewable energy sources over 1990 together with a reduction of 20% in primary energy source consumption and CO<sub>2</sub> emissions.

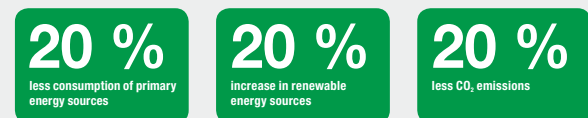

## TECHNICAL SPECIFICATIONS

MODEL	LGF-100GX-E				
Speed		Extra High	High	Low	
Air flow	m <sup>3</sup> /h	995	995	890	
Static pressure	Pa	200	150	119	
Temp. Exchange Effic.	%	80	80	81	
Enthalpic exchange efficiency	Heating	%	72.5	72.5	74
	Cooling	%	71	71	72
Sound pressure	dB(A)	49	47	44	
Weight	kg	164			
Power	A single-phase 220-240VAC 50Hz				
Power absorption	W	922	790	785	
Dimensions	HxLxW	mm 1095x1760x674			

# GUF-RDH4



Monoblock indoor unit with fresh air intake fan, stale air exhaust fan, filtration system, Lossnay total heat recovery module, bypass shutter, permeable film humidifier and direct expansion coil.



## RDH4 Series

### GUF-50RDH4

Cooling capacity 5.46 (DX coil: 3.63, Lossnay core: 1.83) kW Heating capacity 6.18 (DX coil: 4.17, Lossnay core: 2.01) kW 500 m<sup>3</sup>/h 220-240V 50Hz single-phase

### GUF-100RDH4

Cooling capacity 11.17 (DX coil: 3.63, Lossnay core: 3.85) kW Heating capacity 12.50 (DX coil: 8.30, Lossnay core: 4.20) kW 500 m<sup>3</sup>/h 220-240V 50Hz single-phase

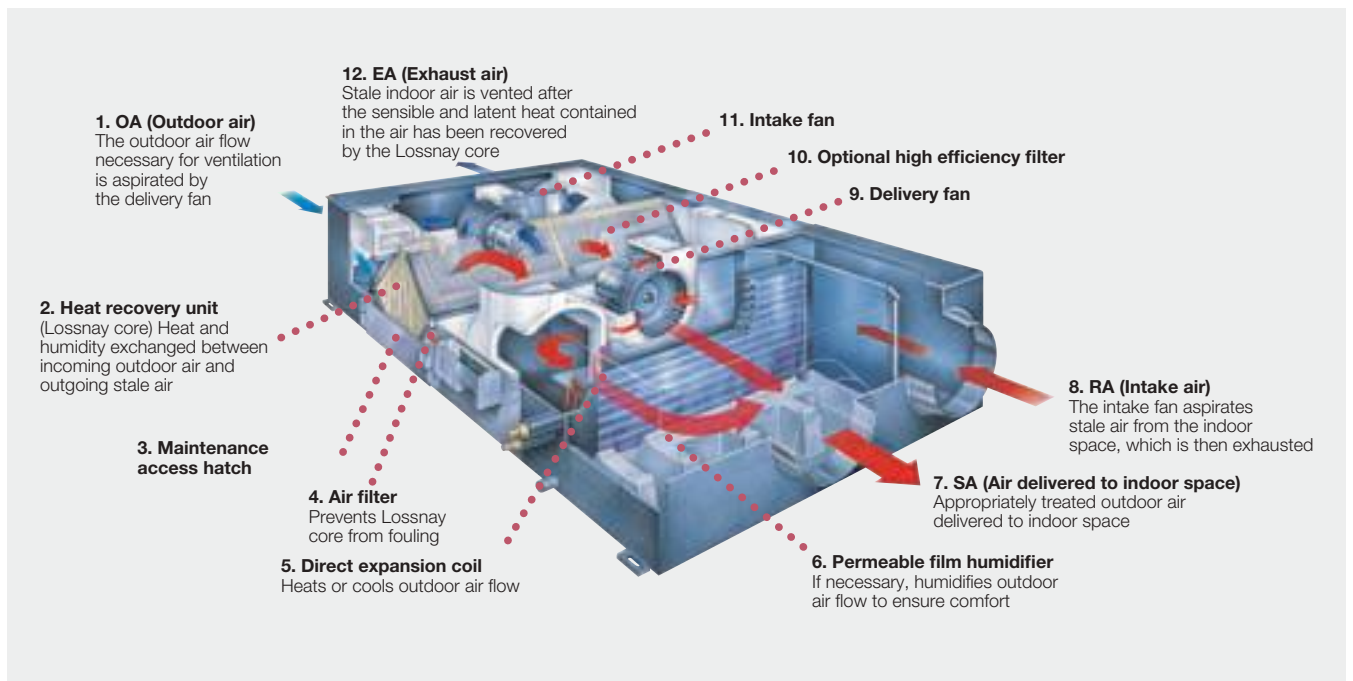

## Lossnay technology

The Lossnay total heat recovery module has a cross-flow plate fin structure and heat transfer diaphragms in special treated paper. The excellent thermal transfer properties and permeability to moisture of this special paper ensure the highly efficient exchange of **both sensible and latent heat** between the two air flows passing through the recovery core. The result is a ventilation system with outstanding characteristics ensuring extremely high levels of comfort and wellbeing in the environment treated, which can also cut operating costs substantially.

The incoming fresh air and outgoing stale air cannot mix within the core. The diaphragm pores, which were already microscopic

in previous generations, have been further reduced in size to reduce the possibility of the passage of waterborne soluble gases such as ammonia and hydrogen. To increase heat and moisture exchange, a special treatment is applied to the paper used for the diaphragms. These improvements have increased moisture permeability while reducing permeability to harmful gases, resulting in an overall increase in recovery efficiency and a more effective barrier action against the transfer of these gases.

### CONSTRUCTION AND OPERATING PRINCIPLE OF LOSSNAY UNIT

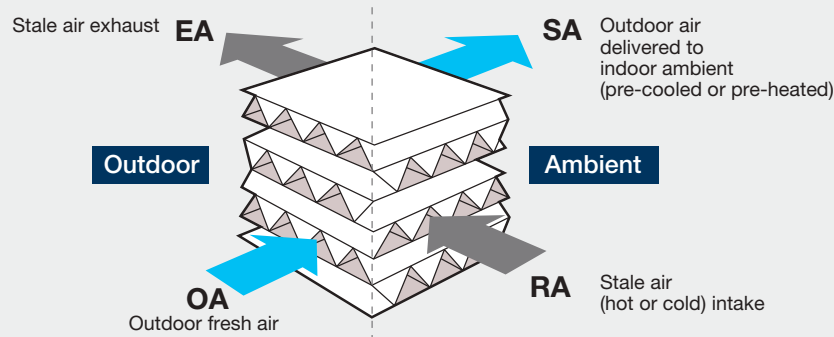

## Heat exchanger

A direct expansion coil incorporated in the unit makes it possible to cover approximately 25% of the load of the system with the **GUF** unit. This also means that the terminal units installed in the indoor space can be smaller. Moreover, as the **GUF** unit covers the entire thermal load attributable to ventilation, this means that this load and the ambient load can be managed completely separately, simplifying the design process of the installation. The treated air heats the humidifier as it passes through it, further increasing humidification efficiency.

## Total comfort

Maintaining the correct humidity levels in an indoor space ensures the ideal conditions for comfort and prevents the *unpleasant side-effects typical of an environment with insufficient humidity such as dry eyes and throat.*

The evaporation surface area is approximately 8.5 times larger than in a comparably sized natural evaporation humidifier, while performance is 6 times greater.

### IN GENERAL

GUF – For optimum indoor air quality  
GUF = (Lossnay) + (heating & cooling)

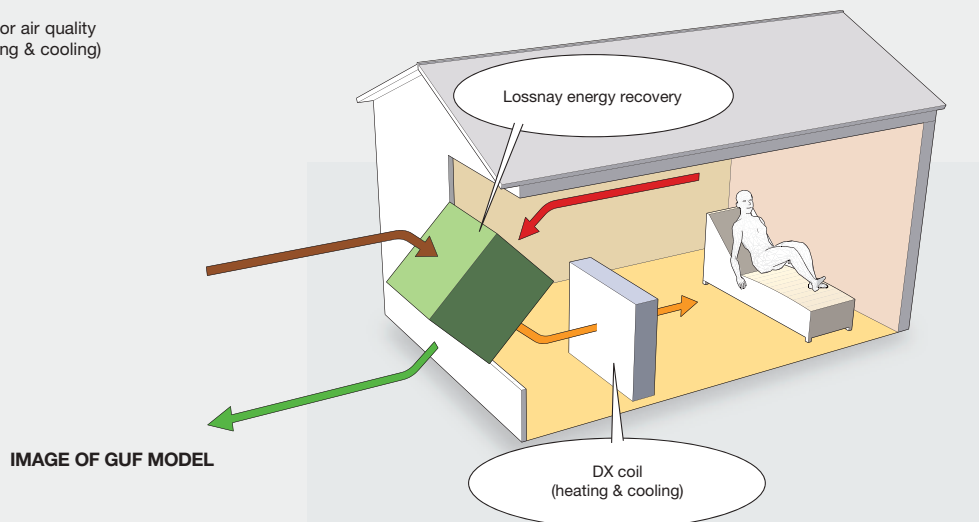

IMAGE OF GUF MODEL

# GUF-RDH4

## Humidification

The innovative permeable film humidification system, which uses a natural evaporation process, is a particularly intelligent solution.

The efficiency with which the air is humidified has been significantly increased by reducing the resistance of the material used. A three-layer film ensures that only the necessary moisture is transferred to the air without any limescale dust release – a problem of certain conventional humidifiers.

Maintaining the correct humidity levels in an indoor space ensures the ideal conditions for comfort and prevents the unpleasant side-effects typical of an environment with insufficient humidity such as dry eyes and throat.

The evaporation surface area is approximately 8.5 times larger than in a comparably sized natural evaporation humidifier, while performance is 6 times greater.

*Note: Use a demineraliser if residual total salt levels exceed 100 mg/l.*

## Increased efficiency of humidification process

Optimised air flows within the unit together with a water injection system have significantly increased the efficiency of the humidification process. The system also controls the humidity in the outgoing stale air to *effectively improve the air quality of the outdoor environment as well*. This solution prevents limescale and silica dust from being carried in the air, so purer, less dusty air is vented into the outdoor environment.

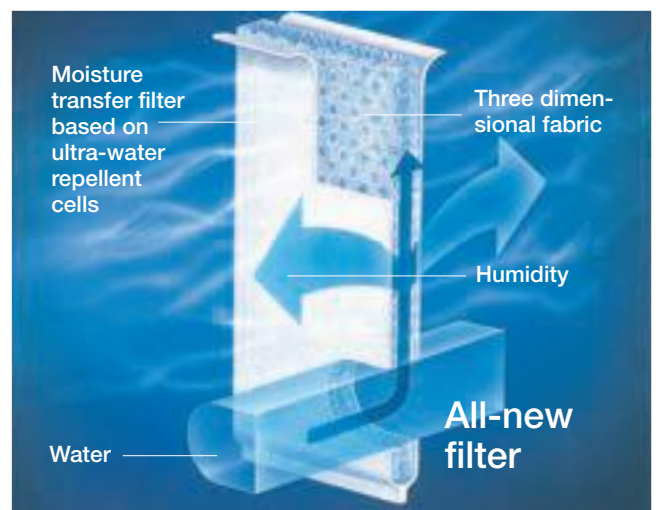

## Automatic free cooling

When the air conditioning is operating in cooling mode and the outdoor temperature is lower than the indoor ambient temperature (as normally occurs at night-time in summer), the **GUF** indoor unit recognises this condition and automatically bypasses the recovery core. The cooler outdoor air fed into the indoor space contributes to reducing the cooling demand sustained by the system.

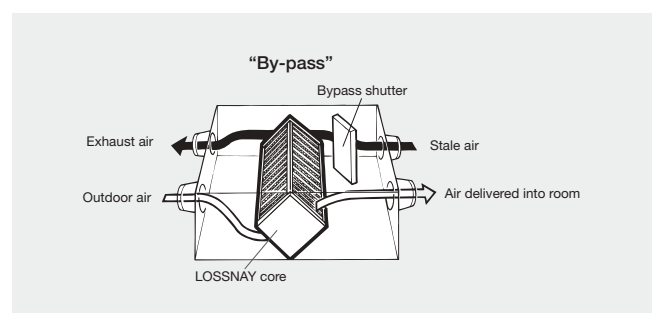

## Dust suppression

An optional high efficiency filter may be used for up to 3,000 hours while maintaining a filtration efficiency (evaluated with colorimetric testing) of over 65%. The filter may also be fitted in the **GUF** unit after initial installation and takes up no additional precious space.

## Automatic regulation

**GUF** ventilation and recovery units may be integrated into a **Melans** control and regulation system for Mitsubishi Electric air conditioner installations, as they use the same bus used for connecting indoor units.

## Installazione flessibile

The positions of air duct connections may be changed as needed to cater for different installation requirements.

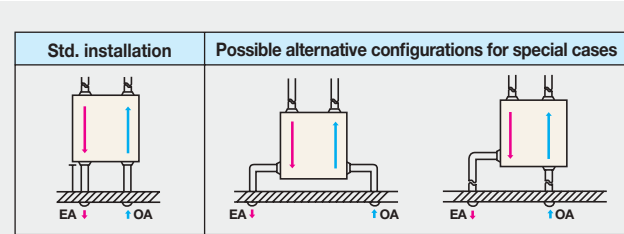

\* Changing the installation configuration causes no any additional pressure loss.

## Advantages

- Reduced energy consumption
- Reduced thermal power necessary to treat outdoor air, equating to lower rated power
- Healthier environment
- Quieter operation (noise baffles in inlet and outlet)
- Free Cooling function using exclusively external air
- Humidification with film permeable to water vapour only
- Total air treatment (neutral air returned to outdoor environment)
- Custom temperature and humidity control
- Compact dimensions
- Installable in double ceilings with limited vertical space.

## Compliant with ErP Directive, Lot 11

EU Regulation 327/2011, effective from 01.01.15, implements the conditions specified in Directive ErP 2009/125 to encourage the design and manufacture of environmentally compatible energy consuming products with the goal of reducing CO<sub>2</sub> emissions and energy consumption by 20% by 2020.

All fans and ventilation units with electric motors with a rated power absorption between 125 W and 500 W fall within the scope of application of this regulation. Mitsubishi Electric GUF-50RDH4 and GUF-100RDH4 outdoor air treatment units are compliant with this directive.

The European Union has set a series of very challenging environmental targets which must be attained by 2020. These targets are grouped together and described with the general title "20/20/20 Package", indicating an increase of 20% in the use of renewable energy sources over 1990 together with a reduction of 20% in primary energy source consumption and CO<sub>2</sub> emissions.

**20 %**  
less consumption of primary energy sources

**20 %**  
increase in renewable energy sources

**20 %**  
less CO<sub>2</sub> emissions

## TECHNICAL SPECIFICATIONS

MODEL		GUF-50RDH4		GUF-100RDH4	
Communication system		Serial communication via M-NET network: Mitsubishi Electric Air Conditioner Network System			
Heat exchanger		Cross fin			
Lossnay core (heat recovery core)	Exchange process	Total (sensible + latent) air-air heat recovery			
	Exchange material	Special treated paper for partitions and spacers			
Casing		Galvanised sheet steel			
Heat insulation material		Self-extinguishing polyurethane foam			
Motors		2 totally enclosed 4-pole permanent-capacitor induction motors			
Fans		Delivery: Centrifugal, ø 220 mm - Intake: Centrifugal, ø 220 mm		Delivery: Centrifugal, ø 245 mm - Intake: Centrifugal, ø 245 mm	
Filtration material		Synthetic fabric			
Ambient operating conditions		From 0 to 40 °C with max. 80% RH			
Functions		Lossnay recovery / Free cooling / High-Low speed switching			
Dimensions, HxLxW	mm (in.)	317 x 1.016 x 1.288 (12-1/2" x 40" x 50-3/4")		398 x 1.231 x 1.580 (15-11/16" x 48" x 62-1/4")	
Weight		57 kg (61 kg when filled with water)		98 kg (106 kg when filled with water)	
Power		Single-phase, 220-240 V, 50 Hz			
Ventilation modes		Lossnay recovery	Free Cooling bypass	Lossnay recovery	Free Cooling bypass
Fan speed		High / Low	High / Low	High / Low	High / Low
Current consumption	A	1.15 / 0.70	1.15 / 0.70	2.20 / 1.76	2.25 / 1.77
Power absorption	W	235-265 / 150-165	235-265 / 150-165	480-505 / 385-400	490-515 / 385-410
Air flow	m <sup>3</sup> /h	500 / 400	500 / 400	1000 / 800	1000 / 800
	(l/s)	139 / 111	139 / 111	278 / 222	278 / 222
Effective overpressure	Pa	125 / 80	125 / 80	135 / 86	135 / 86
Sensible heat recovery efficiency	%	77 / 80	-	79 / 81.5	-
Sensible heat recovery efficiency	In heating mode	66 / 71	-	70 / 74	-
	In cooling mode	61.5 / 66	-	64.5 / 68.5	-
Heating power	kW	6.42 (4.17 direct expansion coil / 2.25 Lossnay core)		13.00 (8.30 direct expansion coil / 4.70 Lossnay core)	
Cooling power	kW	5.29 (3.63 direct expansion coil / 1.66 Lossnay core)		10.81 (7.32 direct expansion coil / 3.49 Lossnay core)	
Equivalent indoor unit power		P 32		P 63	
Humidifier	Humidification	Permeable film			
	Humidification capacity in heating mode	2,7 kg/h		5,4 kg/h	
	Water supply pressure	min. 20 kPa – max. 490 kPa			
Sound pressure at 1.5 m below centre	dB(A)	33.5-34.5 / 29.5-30.5	35-36 / 29.5-30.5	38-39 / 34-35	38-39 / 35-36
Peak current		Less than 2.8 A		Less than 6.0 A	
Insulation resistance		Min. 10 MOhm. (measured with 500 V DC megohmmeter)			
Dielectric strength		500 V AC Hz for 1 minute			

# Outdoor air treatment units

## FAU3 Fresh Air Unit

The FAU series of outdoor air treatment units, with Lossnay enthalpic energy recovery module, direct expansion coil and integrated regulation, is now in its **third generation**, testifying to the commitment of Mitsubishi Electric to continuously improving its air treatment products.

The **new** FAU3 (Fresh Air Unit) may be used to create high capacity air renewal systems which, unlike conventional systems fed with hot and cold fluids, employ more efficient direct expansion technology and ecological R410A refrigerant gas.

The Mitsubishi Electric technological solutions used in direct expansion heat pumps, LOSSNAY total heat recovery modules and in the MELANS control system are integrated in the FAU3 series, making these the most advanced external air treatment units available today in terms of content and function.

Characteristics and features such as superlative energy efficiency, class-topping total heat recovery efficiency for medium and high capacity applications and the same control system used for CITY MULTI VRF air conditioning systems set FAU3 units apart from conventional air treatment units.

The new generation of the FAU3 series gains two additional product lines:

- FAU3 High Efficiency
- FAU3 Standard



## FAU3 Fresh Air Unit

One of the most distinctive characteristics of FAU external air treatment units by Mitsubishi Electric is that they are **packaged** units ready to be installed and run, as all the basic control, regulating and safety components have been installed, tested and validated in the factory.

The heart of the unit is the Lossnay LU-125 static enthalpic heat recovery module – one of the most efficient systems for medium/large capacity applications available today – which is complemented by the superior dehumidifying capacity in both total and partial load conditions, and superior heating efficiency of a direct expansion system.

To allow consultants, clients and end users choosing FAU3 external air treatment units to extend and personalise the

functionality of the units themselves to cater for specific needs, the design of these units already includes provisions for the installation of a series of accessories in situ.

### AVAILABLE MODELS

#### FAU3 High Efficiency

	FAU3-AE5000	FAU3-AE7500	FAU3-AE10000	FAU3-AE12500	FAU3-AE15000
m³/h	5.000	7.500	10.000	12.500	15.000

#### FAU3 Standard

	FAU3-S5000	FAU3-S7500	FAU3-S10000	FAU3-S12500	FAU3-S15000
m³/h	5.000	7.500	10.000	12.500	15.000

## FAU3 High Efficiency

To further accentuate the superior energy efficiency of FAU3 units achieved through the use of a Lossnay total heat recovery module and direct expansion heat pump technology, Mitsubishi Electric presents the FAU3 High Efficiency product line, for use in conjunction with the VRF CITY MULTI external units with high efficiency Y series heat pumps.

As standard, the filtration section of FAU3 High Efficiency units consists of highly efficient Class F9 (EU F9) rigid pocket filters. FAU3-AE (High Efficiency) units are intended for use in conjunction with **Y Ecostandard**, **Y Nominal** or **WY** VRF CITY MULTI outdoor units in the combinations indicated in the following table:



OUTDOOR UNITS	FAU3-AE5000	FAU3-AE7500	FAU3-AE10000	FAU3-AE12500	FAU3-AE15000
<b>PUHY YKB-A1</b>	<b>N°</b>	<b>N°</b>	<b>N°</b>	<b>N°</b>	<b>N°</b>
P200 (8HP)	1		2	1	
P250 (10HP)		1		1	2

## FAU3 Standard

The new FAU3 Standard product line is intended for use in conjunction with “Standard Inverter” direct expansion outdoor units from the Commercial Line. The new FAU3 Standard product line has been conceived to deliver the same heating and cooling capacity as the FAU2, but with different levels of energy efficiency than the FAU3 High Efficiency.

As standard, the filtration section of FAU3 Standard units consists of highly efficient Class F7 (EU F7) rigid pocket filters.

FAU3-S units (Standard) are intended for use in conjunction with **PUHZ-P** external units from the Commercial line in the combinations indicated in the following table:



OUTDOOR UNITS	FAU3-S5000	FAU3-S7500	FAU3-S10000	FAU3-S12500	FAU3-S15000
<b>PUHZ-P YKA</b>	<b>N°</b>	<b>N°</b>	<b>N°</b>	<b>N°</b>	<b>N°</b>
P200 (8HP)	1		2	1	
P250 (10HP)		1		1	2

## Lossnay technology

The Lossnay total heat recovery module has a cross-flow plate fin structure and heat transfer diaphragms in special treated paper. The excellent thermal transfer properties and permeability to moisture of this special paper ensure the highly efficient exchange of both sensible and latent heat between the two air flows passing through the recovery core. The result is a ventilation system with outstanding characteristics ensuring extremely high levels of comfort and wellbeing in the environment treated, which can also cut operating costs substantially. The diaphragm pores, which were already microscopic in previous generations, have been further reduced in size to reduce the possibility of the passage

of waterborne soluble gases such as ammonia and hydrogen from the exhausted stale air to the fresh air delivered to the indoor space.

To increase heat and moisture exchange, a special treatment is applied to the paper used for the diaphragms. These improvements have increased moisture permeability while reducing permeability to harmful gases, resulting in an overall increase in recovery efficiency and a more effective barrier action against the transfer of these gases.

## Integrated electronic regulation

The functional heart of the FAU3 is the electronic controller, which is constructed using FR4 class material and superior quality SMD components. This controller is responsible for all regulation and control functions of the FAU3 and its optional accessories as well as all safety functions of the system.

The controller is equipped with a display backlit with blue light visualising operating parameters and errors for system diagnosis by the maintenance service provider.



## High efficiency ventilation section

The delivery and intake fans are reverse pitch fans with a freewheel rotor and a **high output electronically switched motor**. These are **plug-fan** components, with the motor integrated in the rotor structure. The fans are designed and built for unparalleled silence, with rotor and motor housings in technopolymer or aluminium, while a shaft and stator in steel, for lower internal motor temperatures than a conventional motor, and an absence of current spikes ensure extended lifespan.



## Direct expansion coil

The direct expansion coil, made from 'Inner Grooved' copper tubing and with Blu-Fin V Waffle Louver Fins in corrosion-resistant aluminium for direct expansion applications using R410A refrigerant, features a unique design.

- Inner grooved pipe – groove depth: 0.34 mm
- Metal structure in 15/10 FeZn
- Copper collector boxes – thickness 1.5 mm
- Rated pressure: 46 Bar
- V waffle louver fins in aluminium – thickness 0.1 mm

## High Performance Filtration

Equipped with high efficiency Class **F7 / F9** filters, FAU3 outdoor air treatment units may be used in all the categories of building indicated in the most recent legislation concerning ventilation and air exchange.



**Large variety of accessories and configuration options available**

A wide choice of accessories (which may also be installed after initial installation of the system) and configuration options (which must be specified when ordering) significantly extends the range of applications possible for the FAU3.

**Vapour Humidification System**

The vapour humidification system consists of a supplementary section built within the same structure as the base unit and comprising a condensate collector tray and a vapour distributor. This system is only enabled in HEATING mode and activates when a relative humidity of less than 50% is measured in the interior ambience. The vapour humidification section maintains relative ambient humidity at approximately 50% with outdoor temperatures as low as -5°C and at nominal capacity.



**Two Speed System and alarm and status notification**

The Two Speed system allows the delivery and return fans to be switched between two speeds by an external switch (not supplied by Mitsubishi Electric). The system has been designed to allow a third party BMS (Building Management System) to control the output capacity of the FAU3 on the basis of, for example, a CO<sub>2</sub> sensor indicating percentage occupancy. When operating at low speed, the FAU3 functions at reduced capacity and further lowers consumption.

The Alarm and Status Notification system allows a total of eight alarms and statuses relative to the functions and operation of the FAU3 to be exported to a third party BMS (Building Management System).



Two Speed Board



Alarm and Status Notification Board

**Antifreeze Pre-heat Systems**

Two different antifreeze pre-heat systems are possible, which may be used independently or in combination, for extremely cold climates:

- Modulating electric antifreeze battery
- External bypass antifreeze system: This system bypasses 1/5 of the nominal outgoing air flow from the direct expansion coil and returns it upstream of the delivery fan/s, mixing it with outdoor air at the inlet of the Lossnay enthalpic recovery core.

**High overpressure fan configuration**

The delivery and return fans are factory set for a rated capacity and maximum effective overpressure of 250 Pa. The FAU3 may also be configured to allow the installation of high overpressure fans (400 Pa).

**Unit subdivided into 6 sections**

As an option, the FAU3-5000, 7500, 10000 12500 and 15000 may be supplied in a configuration subdivided into six sections, for situations where mechanical constraints and architectural limitations make it difficult to handle and manoeuvre the assembled FAU3.

**Compliant with ErP Directive, Lot 11**

EU Regulation 327/2011, effective from 01.01.15, implements the conditions specified in Directive ErP 2009/125 to encourage the design and manufacture of environmentally compatible energy consuming products with the goal of reducing CO<sub>2</sub> emissions and energy consumption by 20% by 2020.

All fans and ventilation units with electric motors with a rated power absorption between 125 W and 500 W fall within the scope of application of this regulation. Mitsubishi Electric FAU3 air treatment machines, available as High Efficiency and Standard variants with capacities from 5000 to 15000 m<sup>3</sup>/h, are compliant with this directive

The European Union has set a series of very challenging environmental targets which must be attained by 2020. These targets are grouped together and described with the general title "20/20/20 Package", indicating an increase of 20% in the use of renewable energy sources over 1990 together with a reduction of 20% in primary energy source consumption and CO<sub>2</sub> emissions.

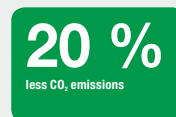
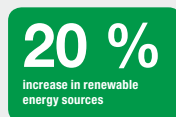
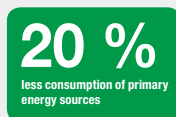

# FAU3 Outdoor air treatment units

## FAU3 High Efficiency



### TECHNICAL SPECIFICATIONS

MODEL		FAU3-AE5000	FAU3-AE7500	FAU3-AE10000	FAU3-AE12500	FAU3-AE15000
<b>Rated air flow</b>	m <sup>3</sup> /h	<b>5000</b>	<b>7.500</b>	<b>10.000</b>	<b>12.500</b>	<b>15.000</b>
Air flow range	m <sup>3</sup> /h	3.500~5.000	5.500~7.500	8.000~10.000	10.500~12.500	13.000~15.000
<b>Max effective overpressure</b> (default configuration)	Pa	<b>250</b>	<b>250</b>	<b>250</b>	<b>250</b>	<b>250</b>
Max effective overpressure (High Overpressure Version)*1	%	400	400	400	400	400
DX Coil Power, Cooling	kW	22,40	28,00	44,80	50,40	56,00
Recovery core power, Cooling	kW	25,90	38,85	51,80	64,75	77,70
Total power, Cooling	kW	48,30	66,85	96,60	115,15	133,70
DX coil power, Heating	kW	25,00	31,50	50,00	56,50	63,00
Recovery core power, Heating	kW	20,40	30,60	40,80	51,00	61,20
Total power, Heating	kW	45,40	62,10	90,80	107,50	124,20
Sensible heat recovery efficiency	%			72		
Total heat recovery efficiency Cooling	%			62		
Total heat recovery efficiency Heating	%			67		
Number of Recovery Modules	No.	4	6	8	10	12
Filter Section		Rigid pocket, Class F9 (EU9)				
Humidification Section (optional accessory)	kg/h	15	18	25	35	45
Sound pressure	dB(A)	73	77.9	78.3	79.9	80.9
EER of system with PUHY-P*2 (Y Nominal)		5.34	5.80	5.62	5.65	5.47
COP of system with PUHY-P*2 (Y Nominal)		4.70	5.18	4.93	5.01	4.89
EER of system with PQHY-P*2		6.22	6.62	6.60	6.52	6.19
COP of system with PQHY-P*2		5.70	5.94	6.04	5.90	5.57

\*1 Configuration option specifiable in order. Contact head office for more details.

\*2 In nominal conditions, see notes below.

The values given are for the following nominal conditions:

	SUMMER	
Indoor	27°C DB.	50% RH
Outdoor	35°C DB	50% RH

	WINTER	
Indoor	20°C DB	50% RH
Outdoor	7°C DB	85% RH

Operating temperature range: 0°C to 43°C DB

## FAU3 Standard



### TECHNICAL SPECIFICATIONS

MODEL		FAU3-S5000	FAU3-S7500	FAU3-S10000	FAU3-S12500	FAU3-S15000
<b>Rated air flow</b>	m <sup>3</sup> /h	<b>5000</b>	<b>7.500</b>	<b>10.000</b>	<b>12.500</b>	<b>15.000</b>
Air flow range	m <sup>3</sup> /h	3.500~5.000	5.500~7.500	8.000~10.000	10.500~12.500	13.000~15.000
<b>Max effective overpressure</b> (default configuration)	Pa	<b>250</b>	<b>250</b>	<b>250</b>	<b>250</b>	<b>250</b>
Max effective overpressure (High Overpressure Version)*	%	400	400	400	400	400
DX Coil Power, Cooling	kW	22,40	28,00	44,80	50,40	56,00
Recovery core power, Cooling	kW	25,90	38,85	51,80	64,75	77,70
Total power, Cooling	kW	48,30	66,85	96,60	115,15	133,70
DX coil power, Heating	kW	25,00	31,50	50,00	56,50	63,00
Recovery core power, Heating	kW	20,40	30,60	40,80	51,00	61,20
Total power, Heating	kW	45,40	62,10	90,80	107,50	124,20
Sensible heat recovery efficiency	%	72				
Total heat recovery efficiency Cooling	%	62				
Total heat recovery efficiency Heating	%	67				
Number of Recovery Modules	No.	4	6	8	10	12
Filter Section		Rigid pocket, Class F7 (EU7)				
Humidification Section (optional accessory)	kg/h	15	18	25	35	45
Sound pressure	dB(A)	72.8	77.9	78.2	80.0	80.9
EER of system with PUHZ <sup>2</sup>		3.39	3.85	3.50	3.67	3.70
COP of system with PUHZ <sup>2</sup>		3.49	3.55	3.61	3.54	3.41

\*1 Configuration option specifiable in order. Contact head office for more details.

\*2 In nominal conditions, see notes below.

The values given are for the following nominal conditions:

	SUMMER	
Indoor	27°C DB.	50% RH
Outdoor	35°C DB	50% RH

	WINTER	
Indoor	20°C DB	50% RH
Outdoor	7°C DB	85% RH

Operating temperature range: 0°C to 43°C DB

# Heating Serie



---

## INDEX

ECODAN® - VRF HWS & ATW .....	188
ECODAN® - PACKAGED HWHP CAHV (Air to Water) .....	198
ECODAN® - PACKAGED HWHP CRHV (Water to Water) .....	203

Hybrid system

# VRF HWS & ATW



The scalability, flexibility and modularity of the Ecodan® – VRF HWS & ATW system represents the state of the art in Mitsubishi Electric technology. This solution makes it possible to use a single producer – the VRF outdoor unit – to deliver heating water, cooling water and domestic hot water simultaneously.



**LEGENDA**

- ① R2 Outdoor Units
- ② Photovoltaic solar panels
- ③ BC controller
- ④ HWS Hydronic Module
- ⑤ ATW Hydronic Module

- ⑥ Domestic hot water accumulator tank fed from HWS
- ⑦ Hot water inertial accumulator tank fed by ATW

**Green** refrigerant circuit

**Red** domestic hot water circuit

**Orange** heating hot water circuit

**Black** power circuit

Ecodan® heat pump technology has been used in conjunction with hydronic modules to create systems for the production of domestic hot water (HWS) and heating water for radiator panels (ATW) which are perfectly compatible with the inclusion of both thermal and photovoltaic solar panels in the installation. Systems with electric heat pumps may be used all year round, as their use is not restricted by legislation.

The added comfort of being able to use the air conditioning system in spring and autumn is yet another advantage of these VRF systems. The indoor units of the VRF CITY MULTI system gently cool and dehumidify the interior space in spring, cool and dehumidify in summer, transferring the extracted heat to both the HWS and ATW hydronic modules, and heat the interior gently at cooler times of day in autumns.

HWS hydronic modules are ideal for the production of domestic hot water all year round. They make use of the energy drawn from indoor spaces by the VRF indoor units, as well as supplementary energy provided by solar panels in summer and spring.

ATW hydronic modules provide hot water for radiant panel heating in winter and deliver warm water to heat a pool in summer, contributing to maintaining comfortable temperature conditions and making use of the energy drawn from the indoor space by the VRF indoor units supplemented by heat supplied by thermal solar panels.

In systems with this capability, ATW hydronic modules may also be used to deliver refrigerated water to radiant panels in summer.

## HWS Hydronic Module - Hot Water Supply

Mitsubishi Electric was the first to introduce VRF systems for the production of high temperature hot water (up to 70°C), usable for domestic hot water production. The HWS hydronic module represents a significant, innovative technological breakthrough that uses the most advanced refrigeration technology, and has been conceived to be easily integrable with R2/WR2 series VRF CITY MULTI simultaneous cooling / heating systems.

Heat recovery plays a crucial role in these systems, as the HWS hydronic module may be used to extract heat from rooms where

cooling is required, which would otherwise be vented into the outdoor atmosphere, and then use this heat to contribute to hot water production, adding only the supplementary heat necessary to reach the desired temperature.

The HWS hydronic module can produce hot water at temperatures up to 70°C in the return line, with a heating capacity of up to 12.5 kW per module which, however, is scalable in relation to internal demand.

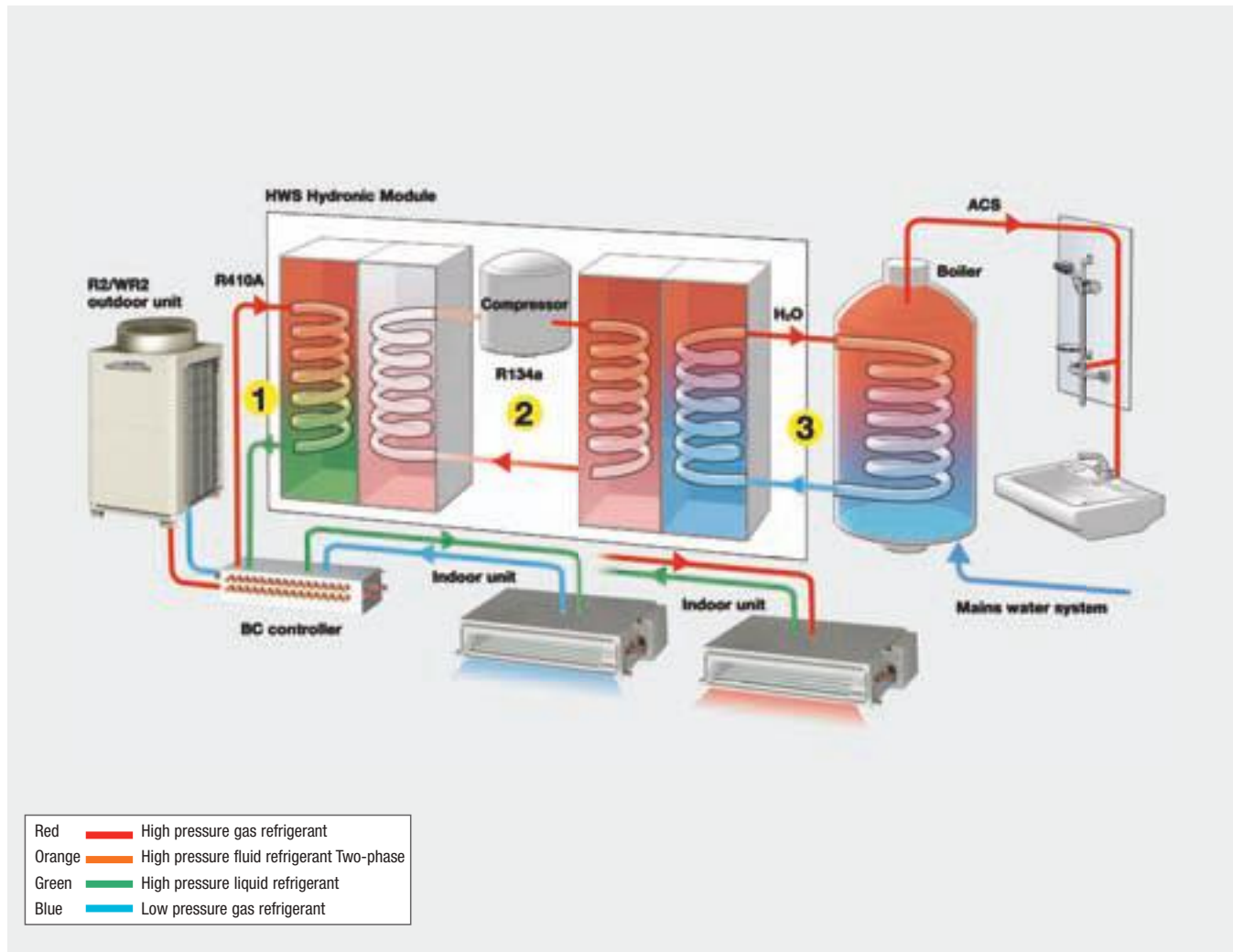

TYPICAL APPLICATIONS: HOTEL (ROOMS)



TYPICAL APPLICATIONS: CENTRALISED RESIDENTIAL SYSTEMS



## Operating principle of two-stage technology

The HWS hydronic module employs a variant of the two-stage compression principle – a principle that has been known and used for many years, but which, until now, has only been applied in refrigeration systems to reach very low temperatures (as low as -60°C). Mitsubishi Electric has redesigned the two-stage circuit to achieve the opposite effect, for units intended to produce heating power at medium to high temperatures, from 30°C to 70°C. This solution combines superior energy efficiency with high hot water

temperatures that are not attainable with the conventional heat pumps currently on the market. As illustrated previously, the HWS hydronic module uses the “free” heat extracted from the air conditioned interior by the heat recovery circuit of the CITY MULTI R2 outdoor units and raises the temperature to the desired value to deliver usable hot water. This double process recovers energy from the system, increasing its overall efficiency, and raises the temperature of the water with minimal energy expenditure.

## Advantages of two-stage technology

The two-stage technology employed in the HWS hydronic module offers a number of significant advantages:

- R134a refrigerant in high temperature stage. R134a is a pure HFC refrigerant which is harmless for the stratospheric ozone layer and contributes only marginally to the greenhouse effect. This refrigerant is particularly suitable for high temperature applications.
- R410A refrigerant in low temperature stage. This is also an HFC refrigerant that is harmless to stratospheric ozone, which offers extraordinary efficiency in air conditioning applications.
- Minimal external energy demand, even when the system is operating in air conditioning mode. The heat drawn from the air is used to heat water.
- When the system functions predominantly in air conditioning mode – in summer, for example – hot water is produced with extremely low energy consumption. This makes it possible for the system to attain very high COP values.
- Continuously variable heating power in relation to demand, made possible by the inverter motor scroll compressor, which reduces energy consumption proportionally.

- Compact dimensions and very light weight. These modules may be mounted on walls, even in intermediate positions. Practically zero floor space usage.
- Individual thermal energy consumption billing with field devices.



## Hybrid systems

The HWS hydronic module may be used to create hybrid systems, with both hydronic modules and VRF direct expansion units. For instance, this makes it possible for the system to produce domestic hot water and heat or cool the air in the indoor space using the most suitable indoor units of the Mitsubishi Electric range (cassette units, ceiling-suspended units, ducted units etc.).

As well as superior energy efficiency, a hybrid system also offers the extraordinary flexibility needed to cater for very diverse situations, which a conventional air conditioner system simply does not.

## Control and Adjustment System

The HWS hydronic module can be configured for the following operating modes and hot water temperatures:

OPERATING MODE	TEMPERATURE RANGE
Hot water	30 - 70°C
Heating	30 - 50°C
ECO heating	30 - 45°C
Antifreeze	10 - 45°C



## TECHNICAL SPECIFICATIONS - HWS HYDRONIC MODULE

			PWFY-P100VM-E-BU
<b>Power</b>			Single-phase, 220-230-240V, 50 Hz/60Hz
<b>Heating power output (nominal)</b>	kW <sup>-1</sup>		12,5
		kcal/h <sup>-1</sup>	10,800
		Btu/h <sup>-1</sup>	42,700
	Power absorption	kW	2,48
Current consumption	A	11,63 - 11,12 - 10,66	
<b>Temp. range in heating mode</b>	PURY Series	Outdoor temp. DB	-20~32°C
	PQRY Series	Water temp. in circuit	10~45°C
	PQRY Series	Temp. in water/glycol circuit (for geothermal applications)	-5~45°C
	PWFY-P VM-E1-BU	Return line water temp.	10~70°C
<b>Connectable outdoor units</b>	Total capacity		50-100% of external unit capacity
	Series		R2 (Nominal (P), Seasonal (EP))
<b>Sound pressure in anechoic chamber</b>	dB <A>		44
<b>Refrigerant circuit piping diameter</b>	Liquid	mm (inches)	ø 9,52 (ø 3/8") brazed
	Gas	mm (inches)	ø 15,88 (ø 5/8") brazed
<b>Water piping diameter</b>	Inlet	mm (inches)	ø 19,05 (R 3/4") screw-on connection
	Delivery	mm (inches)	ø 19,05 (R 3/4") screw-on connection
<b>Drain pipe diameter</b>	mm (inches)		ø 32 (1-1/4")
<b>External finish</b>			Galvanised sheet steel
<b>External dimensions HxLxW</b>		mm	800 (785 without feet) x 450 x 300
<b>Dry weight</b>		kg	60
<b>Compressor</b>	Type		Hermetic scroll compressor with inverter
	Manufacturer		MITSUBISHI ELECTRIC CORPORATION
	Starter method		Inverter
	Power	kW	1
	Lubricant		NEO22
<b>Water in circuit</b>	Nominal (entire operating volume)	m <sup>3</sup> /h	0,6 - 2,15
<b>Internal circuit protection (R134a)</b>	Overpressure protection		Overpressure sensor, pressure switch calibrated to 3.60 Mpa (601 psi)
	Inverter circuit (COMP)		Overcurrent protection, overheat protection
	Compressor		Outlet temperature protection, overheat protection
<b>Refrigerant</b>	Type / original charge		R134a x1.1kg (0,50lb)
	Controller		LEV
<b>Rated pressure</b>	R410a	MPa	4,15
	R134A	MPa	3,60
	Water	MPa	1
<b>Standard equipment</b>	Manuals		Installation manual, Instruction manuals
	Accessory		Water filter, insulating material

Note:

- \* Nominal conditions \*1 and 2\* are subject to EN14511-2:2004(E)
- \* Install the module in an environment with a wet bulb temperature not exceeding 32°C
- \* Due to continuous improvements made to these products, the specifications given above are subject to modification without prior notification.
- \* The module is not designed to be installed outdoors.
- \*1 Nominal heating conditions Outdoor temp.: 7°C DB/6°C WB

- \*1 Nominal heating conditions Outdoor temp.: 7°CDB/6°C WB (45°F DB/43°F WB)  
Pipe Length 7.5 m (24-9/16 feet) – Vertical difference: 0 m (0 feet)

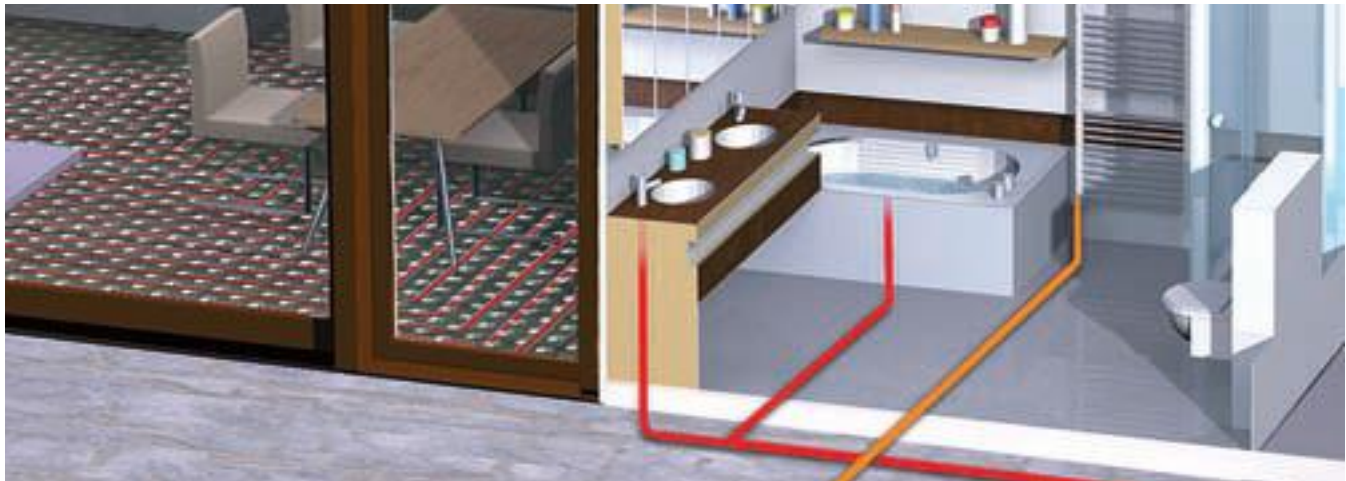

## ATW Hydronic Module – Air To Water

Mitsubishi Electric has developed the ATW reversible air-water heat pump hydronic module specifically for hydronic heating and air conditioning systems. The refrigeration side of the module may be connected to VRF CITY MULTI SMALL Y and Y Series outdoor heat pump units, or to R2 heat recovery units. The hydronic side of the module may feed heated underfloor systems or other similar utilities, to provide heating in winter in heat pump mode, or cooling in summer in conditioning mode.

Connecting these modules to R2 Series VRF CITY MULTI heat recovery outdoor units offers extraordinarily levels of efficiency, especially in spring and autumn, with extremely high COP values. The HWS hydronic module can produce hot water at temperatures up to 40°C in the return line (45°C in delivery line), with a heating capacity of up to 12.5 kW per module which, however, is scalable in relation to internal demand.

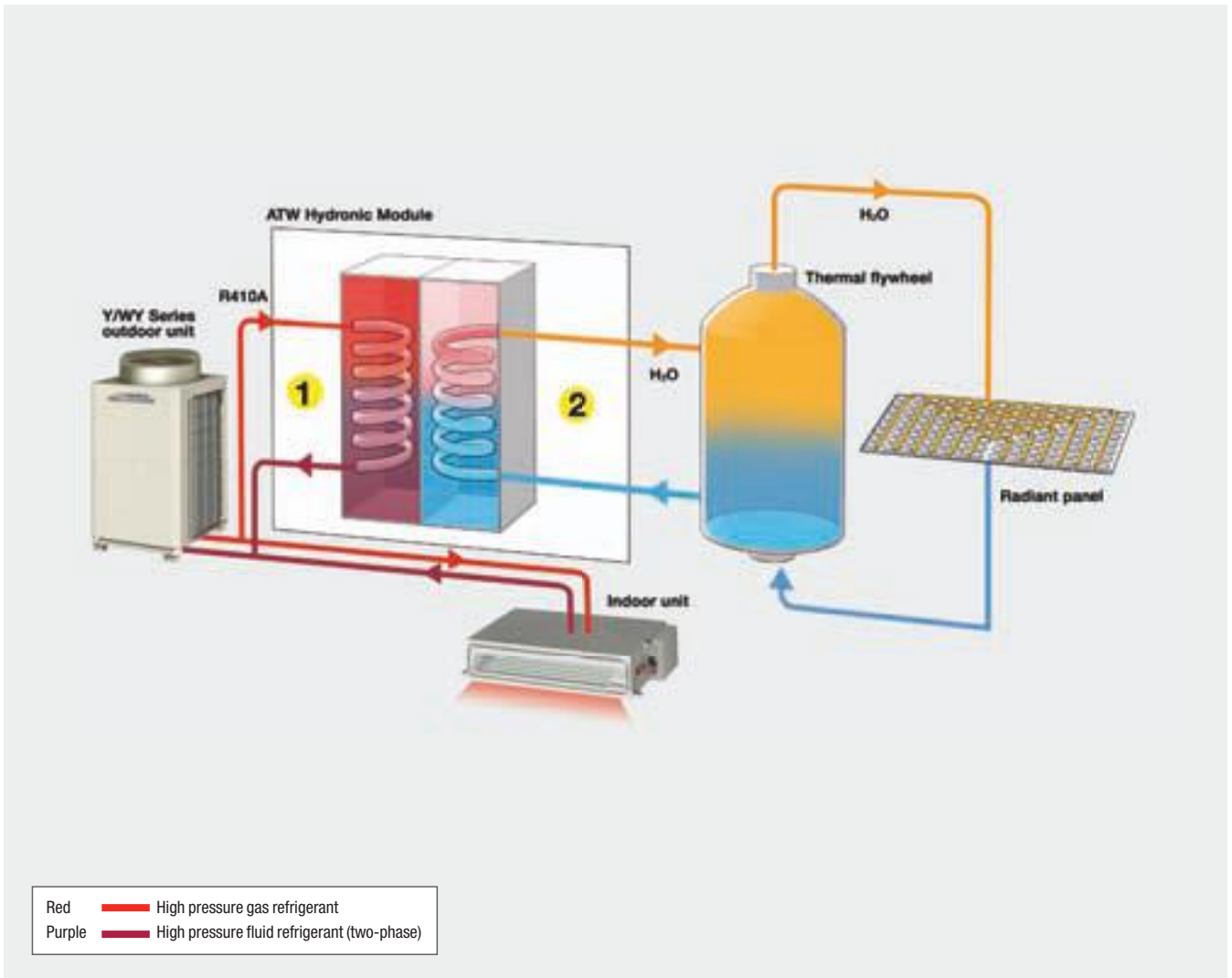

TYPICAL APPLICATIONS: HOTEL (COMMON AREAS)



TYPICAL APPLICATIONS: CENTRALISED RESIDENTIAL SYSTEMS (RADIANT PANEL HEATING)



## Operating principle

The ATW reversible heat pump hydronic module consists essentially of a brazed plate stainless steel refrigerant-water heat exchanger connected to the VRF CITY MULTI outdoor unit on the refrigeration side, and to the hydronic circuit of the system (radiant panels, radiator units etc.) on the water side. The module is equipped with an electronic expansion valve which modulates the flow of refrigerant in the heat exchanger in response to heating or cooling demand and the demand required by the electronic management and control circuit. The entire system is encased in a housing with compact dimensions and very limited weight comparable to a wall-mounted boiler. The high COP value attained by the ATW hydronic module means that it delivers superior comfort with minimal operating costs, contributing to reducing the CO<sub>2</sub> emissions produced for energy production at the power

plant. This offers a two-sided advantage as emissions are not only reduced, but also delocalised away from populated areas.



## Control and Adjustment System

Like the HWS module, the ATW hydronic module is equipped with a sophisticated control system offering a wide choice of functions, selectable in relation to the needs of the installation and the preferences of the user.

The ATW module may be associated with its own independent remote controller (PAR-W21MAA), allowing the user to configure all operating settings, including water temperature, which may be displayed either for the delivery circuit or for the return circuit.

The water temperature reading displayed depends on the type of installation and on the auxiliary controller devices used. The return circuit reading configuration is the most widely used of the two, and allows precise control over the water temperature in the inertial accumulator tank (which is recommended) as a means to balance flows. Once the set temperature is reached, the ATW continues to operate to maintain a constant value.

Note that with this configuration, the delivery temperature is normally higher (max. 45°C) than the set temperature until the set temperature itself is reached.

In installations operating in summer, the ATW produces cold water

at a temperature regulated with the same method, based on the primary delivery circuit reading or the return circuit reading.

As the cooling action of the radiant panels only reduces the sensible heat of the interior space, suitable dehumidification systems may also be included in the installation.

The ATW hydronic module can be configured for the following operating modes and hot water temperatures:

MODE	TEMPERATURE RANGE
Heating	30 - 45°C
ECO heating	30 - 45°C
Antifreeze	10 - 45°C
Cooling	10 - 30°C

## Hybrid systems

Like the HWS module, the ATW hydronic module may be used to create hybrid systems, with both hydronic modules and VRF direct expansion units. For instance, this makes it possible to create a system that can heat certain rooms with radiant panels (a heating solution that is now very popular, as it offers uniform temperatures and quietness) and heat other rooms using appropriate Mitsubishi Electric indoor units (cassette units, wall-mounted units, ducted units etc.). Similarly, conditioning in summer may be performed with a heated underfloor system in rooms where this is installed, and with cooled air in other rooms, via standard VRF indoor units.

This makes it possible to use the most effective treatment solution possible for each interior space, catering for both the requisites of the specific application and the preferences of the user. As well as superior energy efficiency, a hybrid system also offers the extraordinary flexibility needed to cater for very diverse situations, which a conventional conditioning system simply does not.

## Main features

The functional characteristics of the ATW hydronic module cater for the needs of a very wide variety of different installations:

- nominal heating capacity: 12.5 kW;
- nominal cooling capacity: 11.2 kW;
- outdoor operating temperature range, heating mode: -20°C to +32°C (R2 heat recovery series); -20 to +15.5°C (Y heat pump series);
- outdoor operating temperature range, conditioning mode: -5°C to +46°C (R2 and Y series);
- return hot water temperature range: 10°C to 40°C;
- mains power: single-phase, 230V AC;
- individual thermal energy consumption billing with field devices.

# TECHNICAL SPECIFICATIONS - ATW HYDRONIC MODULE

		NEW PWFY-EP100VM-E2-AU	PWFY-P100VM-E2-AU	
<b>Power</b>		Single-phase, 220-230-240V 50/60Hz	Single-phase, 220-230-240V 50/60Hz	
<b>Heating power output (nominal)</b>	kW <sup>*1</sup>	12,5	12,5	
	kcal/h <sup>*1</sup>	10,800	10,800	
	Btu/h <sup>*1</sup>	42,700	42,700	
	Power absorption	kW	0,025	0,025
	Current consumption	A	0,138	0,138
<b>Temp. range in heating mode</b>	Serie PUMY	Outdoor temp. DB	-20~15°C	
	Serie PUHY (Nominal/Seasonal)	Outdoor temp. DB	-20~15,5°C	
	Serie PURY (Nominal/Seasonal)	Outdoor temp. DB	-20~32°C	
	Serie PQHY - PQRV	Water temp. in circuit	10~45°C	
	Serie PQHY - PQRV	Temp. in water/glycol circuit (for geothermal applications)	-5~45°C	
		Return line water temp	10~40°C	10~45°C
<b>Cooling output (nominal)</b>	kW <sup>*2</sup>	11,2	11,2	
	kcal/h <sup>*2</sup>	9,600	9,600	
	Btu/h <sup>*2</sup>	38,200	38,200	
	Power absorption	kW	0,025	0,025
	Current consumption	A	0,138	0,138
<b>Temp. range in cooling mode</b>	PUMY Series	Outdoor temp. B.S.	-	
	PUHY Series (Nominal/Seasonal)	Outdoor temp. B.S.	-5~46°C	
	PURY Series (Nominal/Seasonal)	Outdoor temp. B.S.	-5~46°C	
	PQHY - PQRV Series	Water temp. in circuit	10~45°C	
	PQHY - PQRV Series	Temp. in water/glycol circuit (for geothermal applications)	-5~45°C	
		Return line water temp	10~35°C	10~35°C
<b>Connectable outdoor units</b>	Total capacity	50-100% of capacity of OU	50-100% of capacity of OU	
	Series	Y (Ecostandard (P), Nominal (P), Seasonal (EP)), Zubadan Y, WY, R2 (Nominal (P), Seasonal (EP)), WR2	Small Y (PUMY)	
<b>Sound pressure in anechoic chamber</b>		dB <A>	29	
<b>Refrigerant circuit piping diameter</b>	Liquid	mm (inches)	ø 9,52 (ø 3/8") brazed	
	Gas	mm (inches)	ø 15,88 (ø 5/8") brazed	
<b>Water piping diameter</b>	Inlet	mm (inches)	ø 19,05 (R 3/4") screw-on connection	
	Delivery	mm (inches)	ø 19,05 (R 3/4") screw-on connection	
<b>Drain pipe diameter</b>		mm (inches)	ø 32 (1-1/4")	
<b>External finish</b>			Galvanised sheet steel	
<b>External dimensions HxLxW</b>		mm	800 (785 without feet) x 450 x 300	
<b>Dry weight</b>		kg	36	
<b>Water in circuit</b>	Nominal (entire operating volume)	m <sup>3</sup> /h	1,8-4,30	
			1,1-2,15	
<b>Rated pressure</b>	R410A	MPa	4,15	
	Water	MPa	1	
<b>Standard equipment</b>	Manuals		Installation manual, Instruction manuals	
	Accessory		Water filter, insulating material, 2x external signal connectors, plumbing fittings for filter, flow regulator	

**Note:**

- \* Nominal conditions \*1 and \*2 are subject to EN14511-2:2004(E)
- \* Install the module in an environment with a wet bulb temperature not exceeding 32°C
- \* Due to continuous improvements made to these products, the specifications given above are subject to modification without prior notification.
- \* The module is not designed to be installed outdoors.

- \*1 Nominal heating conditions  
Outdoor temp.: 7°C DB/6°C WB (45°F DB/43°F WB)  
Pipe length: 7.5 m (24-9/16 feet)  
Vertical difference: 0 m (0 feet)  
Intake water temp.: 30°C  
Water flow rate: 2.15 m<sup>3</sup>/h (P100)  
4.30 m<sup>3</sup>/h (P200)

- \*2 Nominal cooling conditions:  
External temp: 35°C DB/(95°F DB)  
Pipe length 7.5 m (24-9/16 feet)  
Vertical difference: 0 m (0 feet)  
Intake water temp.: 23°C  
Water flow rate: 1.93 m<sup>3</sup>/h (P100)  
3.86 m<sup>3</sup>/h (P200)



**Schematic: Ecodan® VRF HWS & ATW** (simultaneous heating, cooling and domestic hot water production)

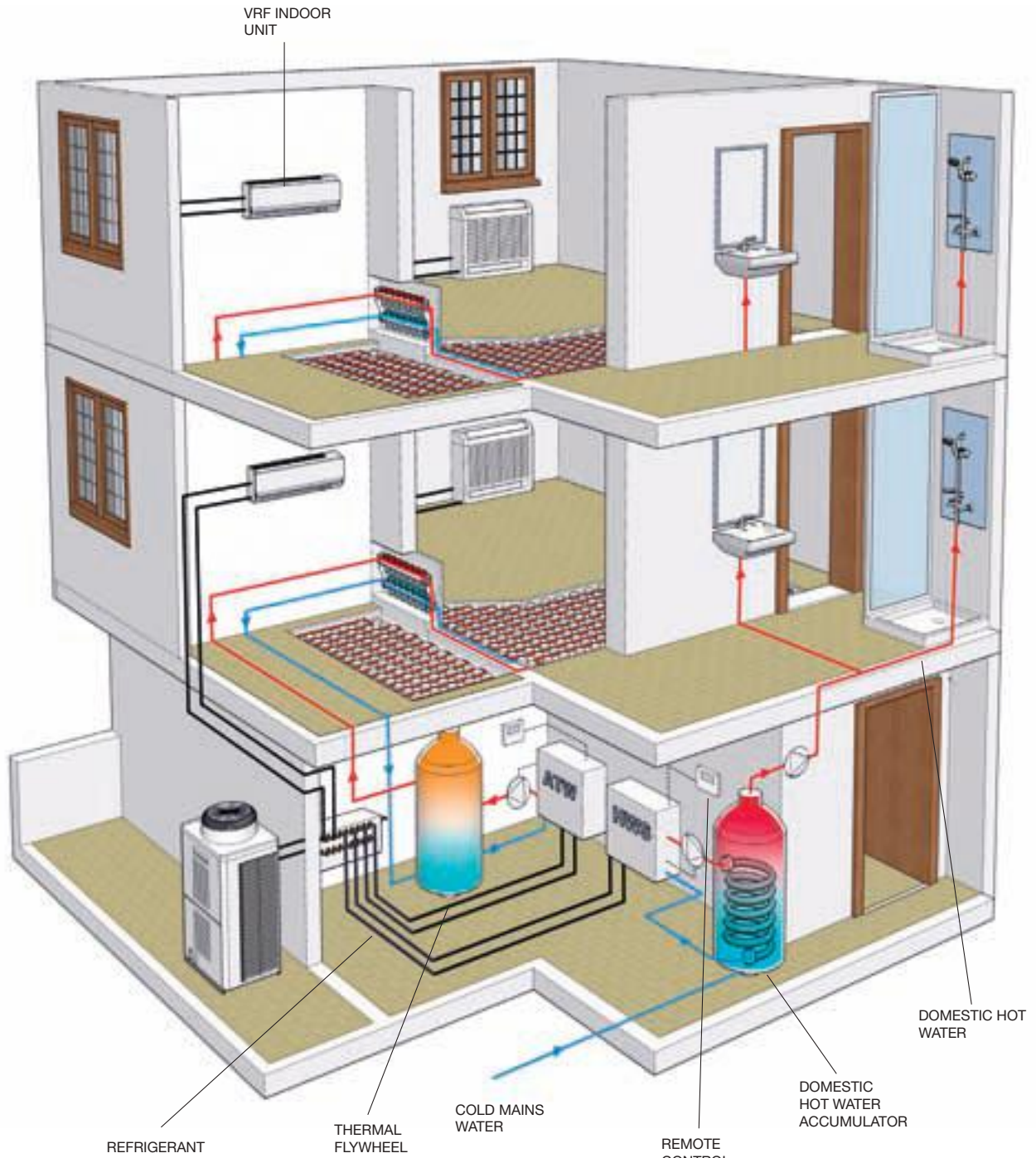

SMALL Y SERIES HEAT PUMP UNITS



The 200% extended connectivity function with outdoor units of the SMALL Y series is only applicable in mixed installations and allows the connection of indoor units (air heating or cooling) and an Ecodan® ATW hydronic module (water heating) with a total capacity index up to 190% of the capacity of the outdoor unit.\*

Y SERIES HEAT PUMP UNITS



With Y Series outdoor units, this function is only applicable in mixed installations and allows the connection of indoor units (air heating or cooling) and an Ecodan® ATW hydronic module (water heating) with a total capacity index up to 200% of the capacity of the outdoor unit.\*

\*In the case of PUMY series outdoor units, a capacity index of 190% is possible with the PUMY P112 Y(V)KM.

R2 SERIES HEAT RECOVERY UNITS

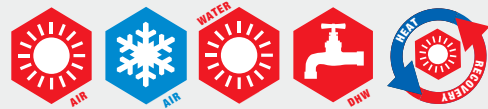
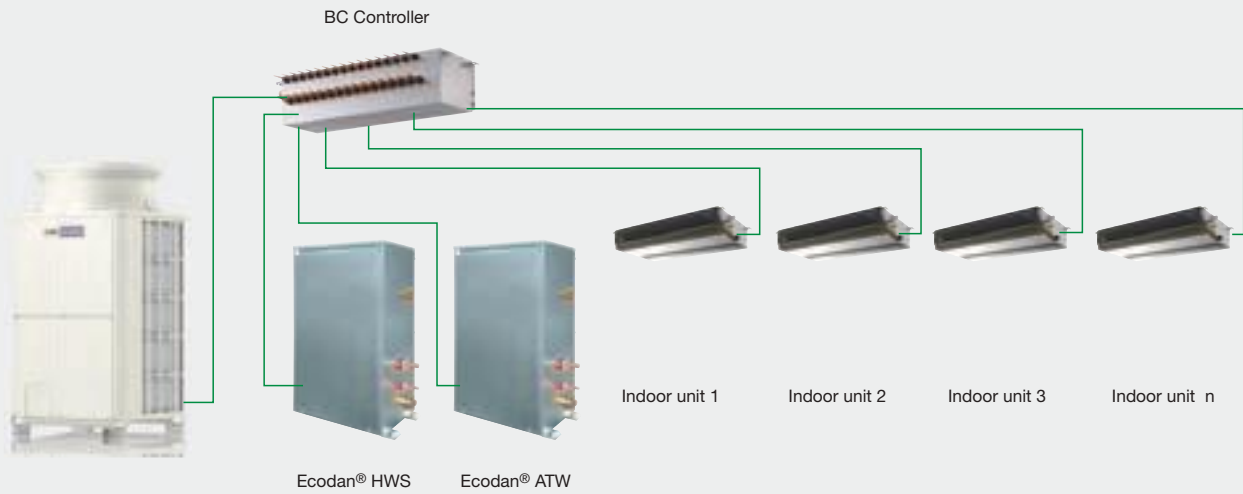

With R2 Series outdoor units operating in different modes, the function is only applicable in mixed installations configured either with the BC Controller or with the WCB refrigerant-water connection box, and permits the connection of indoor units (air heating and cooling) and Ecodan® HWS&ATW hydronic modules (DHW production and water heating) with a total capacity index up to 200% of the capacity of the outdoor unit.\*

\*Contact head office for more details.

System

# PACKAGED HWHP

CAHV (Air to Water)



The Ecodan® - Packaged HWHP (Hot Water Heat Pump) system consists of a monoblock air condensing outdoor unit which produces very high volumes of high temperature hot water.

## Packaged AtW heat pumps for hot water

Mitsubishi Electric has been designing and manufacturing packaged heat pumps for hot water for the commercial sector since 1970. Mitsubishi Electric was one of the first manufacturers in Japan to use heat pump technology to produce hot water. Mitsubishi Electric was also the first manufacturer to develop a range of solutions operating with R407C. Even the first of these units were already capable of producing high temperature hot water at up to 70°C, which is high enough to instantaneously neutralise legionella bacteria.

Our products are still used today in industrial processes requiring high volumes of high temperature water.

Our Hot Water Heat Pump systems are used in commercial applications such as hotels and in hospitals and clinics, testifying to their superior reliability.

As the leading manufacturer of domestic hot water production systems, we are proud to present the efficient "Air to Water" packaged heat pump system.



## Technology



The "Flash-Injection Circuit" developed for the VRF CITY MULTI ZUBADAN Y system (a heat pump system for very cold climates) is installed in the new CAHV packaged Hot Water Heat Pump system. By using this advanced injection system and highly efficient compressors, the CAHV packaged system can deliver high temperature hot water at up to 70°C, and ensures less performance and capacity loss at very low outdoor temperatures.

\* COP 4.13 – Outdoor temperature 7°C DB/ 6°C WB. Outlet water temperature 35°C.

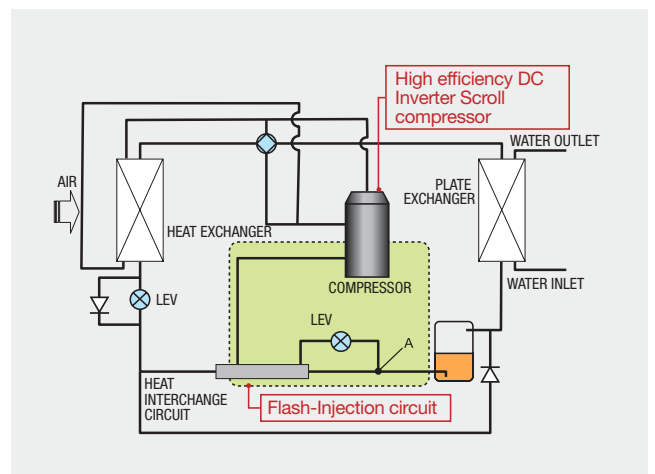



## Class beating heating capacity

**MAX.  
70kW  
Over\***

The CAHV packaged system offers unrivalled flexibility with 2 operating modes to cater for every possible need: “Efficiency Mode (COP)” and “Capacity Mode”. The system is capable of delivering a maximum capacity exceeding 70 kW in Capacity mode, while Efficiency mode (COP) is extremely effective for maximising energy efficiency in all operating conditions and, as a consequence, reducing CO<sub>2</sub> emissions.

\* Outdoor temperature 20°C DB, Water outlet temperature 35°C. Relative humidity 85%. In Capacity mode.

## Efficiency mode (COP)

Outlet water temperature 35°C.	Outdoor temperature °C DB	-20	-10	0	7	20
	Capacity kW	31.9	40.3	42.7	45.0	45.0

## Capacity Mode

Outlet water temperature 35°C.	Outdoor temperature °C DB	-20	-10	0	7	20
	Capacity kW	31.9	40.3	42.7	63.4	73.9

## Operation guaranteed at temperatures as low as -20 °C

**Operable even at  
-20°C**

The CAHV packaged system is capable of operating at outdoor temperatures from -20°C to 40°C. The system produces high temperature hot water (65°C), even on the coldest days of the year.

In the defrost cycle, the two compressors of the system operate in alternation to limit the drop in delivery temperature.

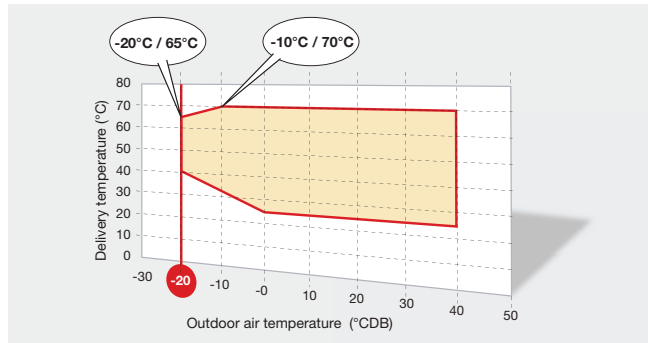

## Backup Function and Rotation Function

**Backup Function  
Rotation Function**

The “Backup\*” function of the CAHV packaged system ensures superior reliability. If one of the two DC Scroll Inverter compressors equipping the individual system fails, the other compressor continues to operate to prevent the discomfort caused by the system shutting down completely. In this state, however, the thermal capacity of the system is obviously halved.

The “Rotation” function is another key solution ensuring uniform operation and maximising the life span of all the compressors in CAHV packaged systems in multiple configurations. In an installation with two or more systems, the individual systems operate in alternation if the thermal demand does not require the systems to function simultaneously.

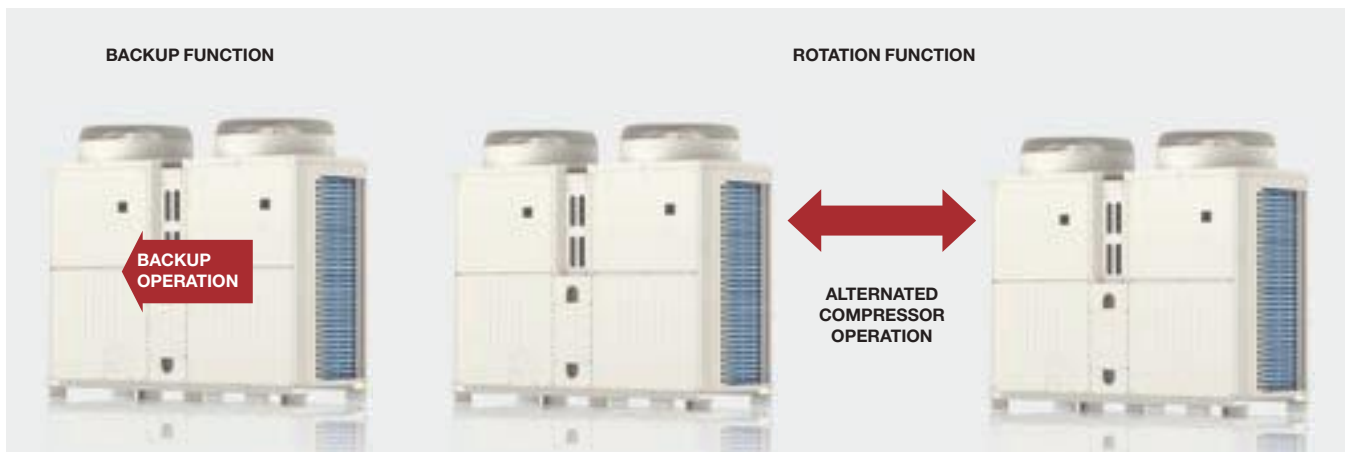

## High overpressure fans

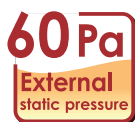

The new fan technology employed in the CAHV packaged system means that it can also be used to create ducted installations, further increasing the installation flexibility of the system. The static external pressure of the fans is settable from 0 Pa to 60 Pa.

## Remote control via external contacts



The wide choice of analogue and digital inputs and digital outputs available on the electronic board of the system makes it possible to control the system remotely from a BMS, a timer or external contacts.

The following are just some of the available input signals:

- Operating mode and hot water production temperature setpoint selection, choosing between "Heating Mode" and "ECO Heating Mode". The latter of these two modes is particularly advanced, as it uses the outdoor air compensation curve to automatically determine the water delivery setpoint.
- Operating mode and hot water production temperature setpoint selection, choosing between "Domestic Hot Water Mode" and "Heating Mode". This means that two different water temperature setpoints are settable: a higher value for domestic hot water production and lower value for heating. This improves performance at partial loads, as DHW is only produced when requested.
- Select between "Efficiency Mode (COP)" and "Capacity Mode" for the unit. The operation of the system may be optimised in relation to demand, increasing power or performance depending on the specific case.

- Select ON/OFF state in relation to signals received from flow regulator switch and circulation pump, for increased protection of the hydronic circuit and to ensure that the system functions correctly.

The following are just some of the available output signals:

- A digital output may be activated at a selectable minimum water temperature to start a thermal power generator (boiler, thermal solar panel etc.) to substitute the system when the system is in OFF state.
- Unit defrost signal.

The result is extraordinary control flexibility either locally, using the dedicated PAR-W21MAA remote controller, or remotely, using external contacts.

## Control and monitoring functionality with centralised WEB Server controllers

The CAHV packaged system is capable of interfacing via the M-Net data transmission bus with the **WEB Server 3D Touch** and **3D Blind Controller** centralised controllers of the VRF CITY MULTI control system range.

Depending on the application, the CAHV packaged system may be interfaced with a VRF CITY MULTI system to optimise operation when catering for hot water, heating and air conditioning demands, or, alternatively, to manage, monitor and supervise the system in stand-alone configuration for applications requiring solely the production of large volumes of hot water.

In both cases, the system may be controlled either from the 10.4" backlit, touch screen colour display of the 3DT controller, or via the internet using the Web pages of either centralised controller.



## Cascade systems

For applications with demands for very large volumes of hot water production, a flexible, modular thermal power installation may be created with up to 16 CAHV packaged systems, for a maximum output of up to 720 kW. This installation solution offers superlative modularity, as each individual system is equipped with two DC Scroll Inverter compressors, ensuring that the thermal power is adjusted progressively and with extreme precision in relation to the effective demand for hot water. This optimises the operation of the entire installation, with only a portion of the CAHV packaged installation operating in mid-load conditions and during spring and autumn.

A malfunction of one or more CAHV packaged systems does not compromise the operation of the other systems in the installation, ensuring safety and uninterrupted operativity.



## TECHNICAL SPECIFICATIONS

MODEL		CAHV-P500YA-HPB (-BS)	
<b>Power</b>		A 3 phase e 4 cables 380-400-415V 50/60Hz	
<b>Nominal heating nominal<sup>*1</sup></b>		kW	45
	Power absorption	kW	12.9
	Current consumption	A	21.78-20.69-19.94
	COP		3.49
<b>Nominal heating nominal<sup>*2</sup></b>		kW	45
	Power absorption	kW	10.9
	Current consumption	A	10.6
	COP		4.13
<b>Nominal heating nominale<sup>*3</sup></b>		kW	45
	Power absorption	kW	25.6
	Current consumption	A	43.17-41.01-39.53
	COP		1.76
<b>Temperature range</b>	Delivery water temperature		25 ~ 70°C
	Outdoor air temperature	°CBS	-20 ~ 40°C
<b>Water pressure loss</b>			12.9kPa
<b>Volume of water in circuit</b>			7.5 m³/h – 15.0 m³/h
<b>Water piping diameters</b>	Return	mm	38.1 (Rc 1 ½") threaded
	Delivery	mm	38.1 (Rc 1 ½") threadedx
<b>Sound pressure <sup>*1</sup> a 1 m</b>		dBA	59
<b>Sound pressure <sup>*1</sup> a 10 m</b>		dBA	51
<b>External dimensions</b>	HxLxP	mm	1710 x 1978 x 759
<b>Dry weight</b>		kg	526
<b>R407C refrigerant charge quantity</b>		kg	5.5 x 2

Note:

<sup>\*1</sup> Nominal heating conditions: outdoor temperature 7°C DB/6°C WB; delivery water temperature 45°C; return water temperature 40°C.

<sup>\*2</sup> Nominal heating conditions: outdoor temperature 7°C DB/6°C WB; delivery water temperature 35°C; return water temperature 30°C.

<sup>\*3</sup> Nominal heating conditions: outdoor temperature 7°C DB/6°C WB; delivery water temperature 70°C.

\* The water circuit must be a closed circuit.

\* Install the unit in a location where the outdoor wet bulb temperature does not exceed 32°C.

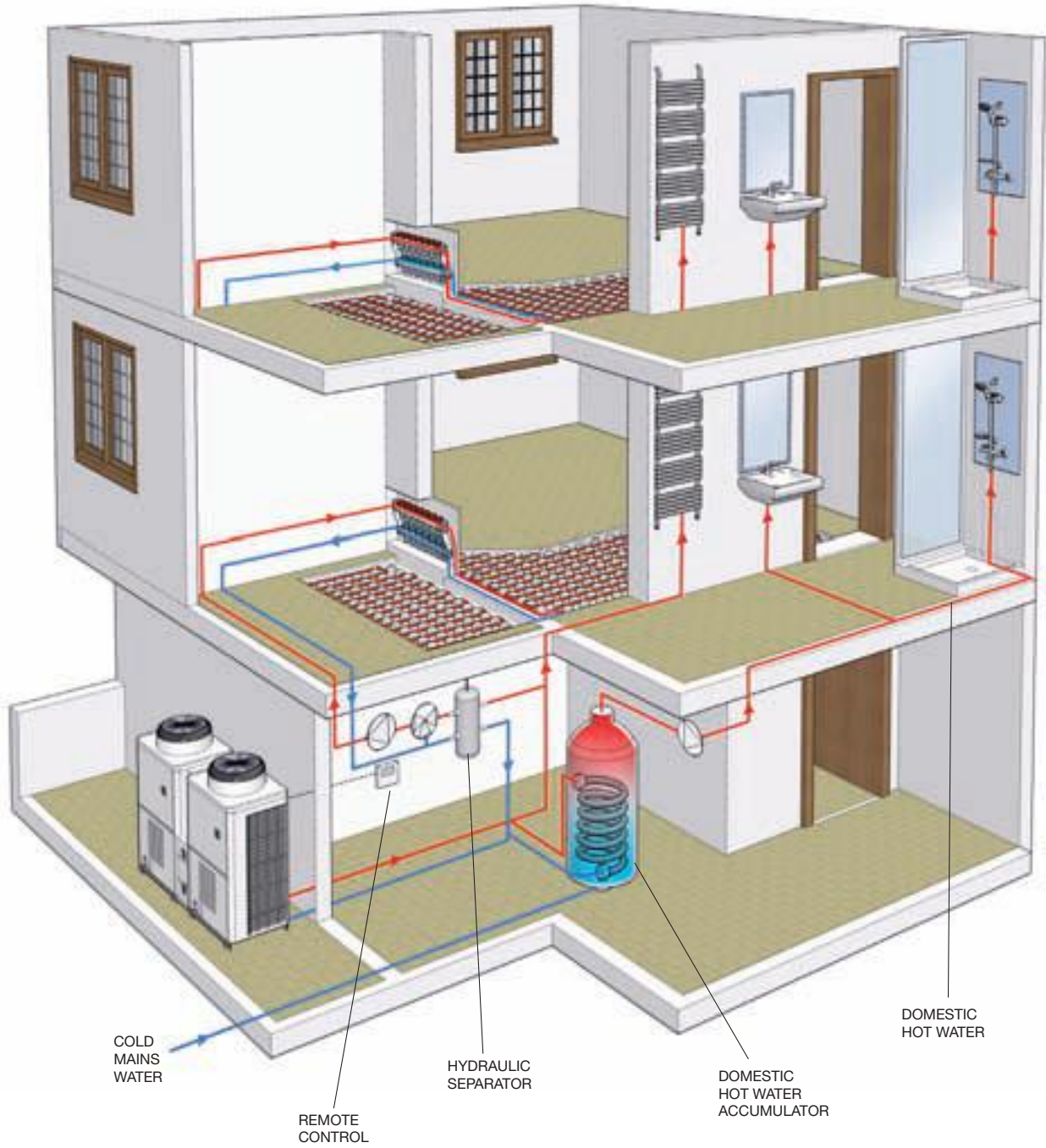

System

# PACKAGED HWHP

CRHV (Water to Water)



The Ecodan® - Packaged HWHP (Hot Water Heat Pump) system consists of a monoblock water condensing outdoor unit which produces very high volumes of high temperature hot water.

## Packaged WtW heat pumps for hot water

The new Hot Water Heat Pump Packaged Water to Water CRHV completes the Mitsubishi Electric range of heat pumps for hot water production, confirming its leadership in the production of these systems. Equipped with two compressors using R410A refrigerant delivering a nominal capacity up to 60kW and drawing energy from the ground, the CRHV packaged system is the ideal solution for geothermal applications and applications using borehole, river or lake water as a heat source to produce hot water for heating or domestic hot water up to 65°C. The Hot Water Heat Pump CRHV offers class beating innovation and efficiency.

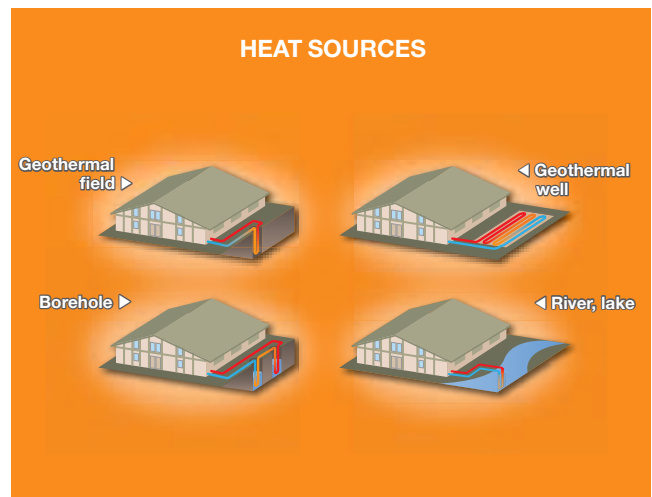

## Technology

**SCOP**  
Over 4\*

The new CRHV packaged system is also equipped with "Flash-Injection Circuit" developed for the VRF CITY MULTI ZUBADAN Y system (a heat pump system for very cold climates). By using this advanced injection system and highly efficient compressors, the CRHV packaged system can deliver high temperature hot water at up to 65°C, ensuring superior performance and capacity even at very cold outdoor temperatures.

\* SCOP 4.33 – Outlet water/glycol temperature -3°C.  
Outlet water temperature 35°C.

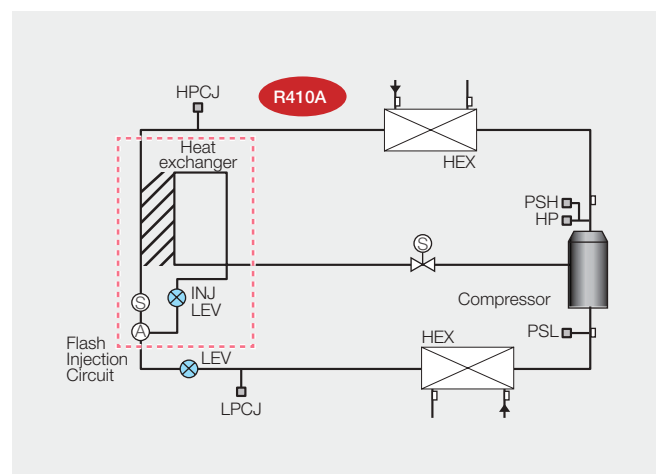

## Upgrading existing systems

The new CRHV packaged system can reuse existing geothermal probes or wells, adapting to their effective thermal capacity. The inverter-driven CRHV packaged system is capable of adjusting its thermal capacity between 45kW and 60kW in relation to the effective amount of heat deliverable by the existing geothermal well.

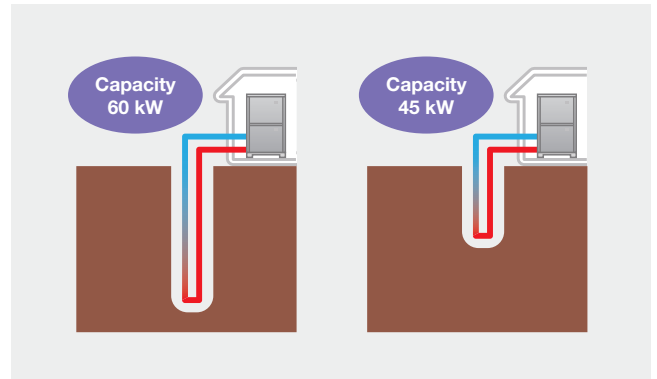

## Operating temperatures

The new CRHV packaged system is capable of operating at incoming source water temperatures between  $-8^{\circ}\text{C}$  and  $27^{\circ}\text{C}$  with a counterflow configuration, while the incoming source water temperature range may be extended to up to  $45^{\circ}\text{C}$  using a parallel flow configuration.

The water delivery temperature range is from  $30^{\circ}\text{C}$  and  $65^{\circ}\text{C}$  (in parallel flow configuration, the maximum water delivery temperature is  $60^{\circ}\text{C}$  at incoming water temperatures above  $27^{\circ}\text{C}$ ). The CRHV packaged system is also suitable for indoor installation.

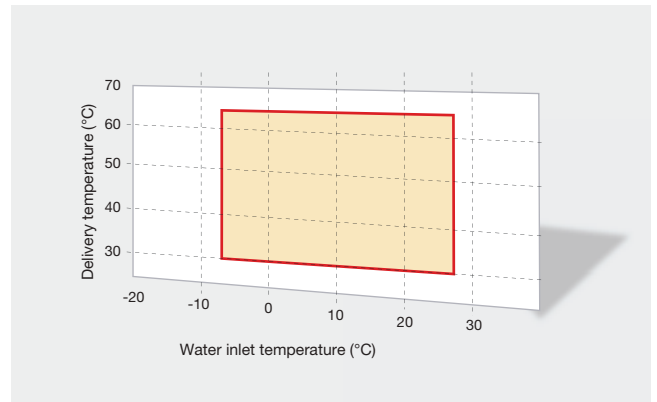

## Backup Function and Rotation Function



The “Backup\*\*” function of the CRHV packaged system ensures superior reliability. If one of the two DC Scroll Inverter compressors equipping the individual system fails, the other compressor continues to operate to prevent the discomfort caused by the system shutting down completely. In this state, however, the thermal capacity of the system is obviously halved.

The “Rotation” function is another key solution ensuring uniform operation and maximising the life span of all the compressors in CRHV packaged systems in multiple configurations. In an installation with two or more systems, the individual systems operate in alternation if the thermal demand does not require the systems to function simultaneously.



## Remote control via external contacts

### Wide variety of external input/output

The wide choice of analogue and digital inputs and digital outputs available on the electronic board of the system makes it possible to control the system remotely from a BMS, a timer or external contacts.

The following are just some of the available input signals:

- Operating mode and hot water production temperature setpoint selection, choosing between “Heating Mode” and “ECO Heating Mode”. The latter of these two modes is particularly advanced, as it uses the outdoor air compensation curve to automatically determine the water delivery setpoint.
- Operating mode and hot water production temperature setpoint selection, choosing between “Domestic Hot Water Mode” and “Heating Mode”.  
This means that two different water temperature setpoints are settable: a higher value for domestic hot water production and lower value for heating. This improves performance at partial loads, as DHW is only produced when requested.
- Select between “Efficiency Mode (COP)” and “Capacity Mode” for the unit. The operation of the system may be optimised in relation to demand, increasing power or performance depending on the specific case.
- Select ON/OFF state in relation to signals received from flow

regulator switch and circulation pump, for increased protection of the hydronic circuit and to ensure that the system functions correctly.

The following are just some of the available output signals:

- A digital output may be activated at a selectable minimum water temperature to start a thermal power generator (boiler, thermal solar panel etc.) to substitute the system in certain conditions when the system is in OFF state.
- Manage 3-way valve in relation to domestic hot water or heating water demand.
- Manage pumps on circuit hot water side and heat source side (ON/OFF).

The result is extraordinary control flexibility either locally, using the dedicated PAR-W21MAA remote controller, or remotely, using external contacts.

## Control and monitoring functionality with centralised WEB Server controllers

The CRHV packaged system is capable of interfacing via the M-Net data transmission bus with the **WEB Server 3D Touch** and **3D Blind Controller** centralised controllers of the VRF CITY MULTI control system range. Depending on the application, the CRHV packaged system may be interfaced with a VRF CITY MULTI system to optimise operation when catering for hot water, heating and air conditioning demands, or, alternatively, to manage, monitor and supervise the system in stand-alone configuration for applications requiring solely the production of large volumes of hot water. In both cases, the system may be controlled either from the 10.4” backlit, touch screen colour display of the 3DT controller, or via the internet using the Web pages of either centralised controller.



## Compact dimensions

The compact footprint of the units has been made possible by a new, highly efficient, low pressure loss heat exchanger. Installation footprint 0.73 m<sup>2</sup>\*

\*footprint of one unit, not including service access space for maintenance.

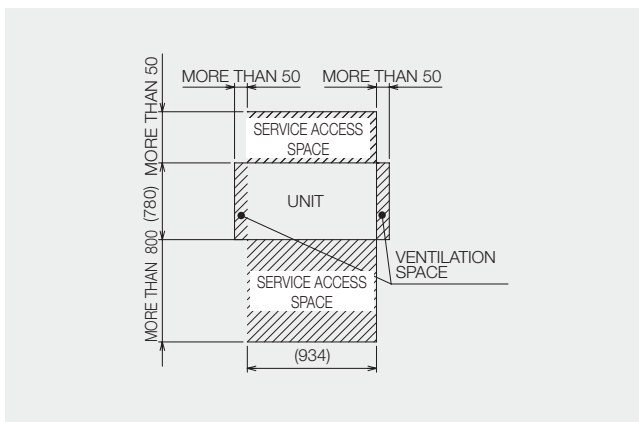

## Finish treatment

The module can also be ordered with an optional special protective treatment for installation in particularly harsh or corrosive environments.



## Cascade systems

For applications with demands for very large volumes of hot water production, a flexible, modular thermal power installation may be created with up to 16 CRHV packaged systems, for a maximum output of up to 960 kW, with integrated cascade control. This installation solution offers superlative modulability, as each individual system is equipped with two DC Scroll Inverter compressors, ensuring that the thermal power is adjusted progressively and with extreme precision in relation to the effective demand for hot water.

This optimises the operation of the entire installation, with only a portion of the CRHV packaged installation operating in mid-load conditions and during spring and autumn.

A malfunction of one or more CRHV packaged systems does not compromise the operation of the other systems in the installation, ensuring safety and uninterrupted operativity.



## TECHNICAL SPECIFICATIONS

MODEL		CRHV-P600YA-HPB	
<b>Power</b>		A 3-phase and 4 cables 380-400-415V 50/60Hz	
<b>SCOP (power 60 kW) EN14825</b>	Heat source water/glycol 0/-3°C, Hot water 30/35°C		4.33
<b>Ave. climate conditions</b>	Heat source water/glycol 0/-3°C, Hot water 47/55°C		2.86
<b>Nominal heating capacity 1<sup>1</sup></b>		kW	60
	Power absorption	kW	14.2
	Current consumption 380-400-415V	A	24.0 - 22.8 - 22.0
	COP		4.23
	Flow rate of water in circuit	m <sup>3</sup> /h	10.3
	Flow rate of heat source water/glycol	m <sup>3</sup> /h	14.7
<b>Nominal heating capacity 2<sup>1</sup></b>		kW	45.0
	Power absorption	kW	10.2
	Current consumption 380-400-415V	A	17.2 - 16.4 - 15.8
	COP		4.41
	Flow rate of water in circuit	m <sup>3</sup> /h	7.7
	Flow rate of heat source water/glycol	m <sup>3</sup> /h	11.2
<b>Heat source liquid</b>		Ethylene glycol 35 WT% (freezing point -18°C)	
<b>Water pressure loss</b>	Hot water side <sup>2</sup>	kPa	14
	Heat source water/glycol side <sup>2</sup>	kPa	38
<b>Temperature range</b>	Hot water side	°C	Hot water delivery 30 ~ 65
	Heat source water/glycol side	°C	(at inlet from source) -8 ~ 27
<b>Hot water/heat source piping diameter</b>	Return	mm (int)	50.8 (Rc 2") threaded
	Delivery	mm (int)	50.8 (Rc 2") threaded
<b>Flow rate of water in circuit</b>	Hot water side	m <sup>3</sup> /h	3.2 – 15.0
	Heat source water/glycol side	m <sup>3</sup> /h	4.5 – 16.0
<b>Installation environment<sup>4</sup></b>		indoor	
<b>Sound pressure (measured in anechoic chamber) at 1 m<sup>3</sup></b>		50	
<b>Sound pressure (measured in anechoic chamber)<sup>3</sup></b>		66	
<b>Dimensions</b>	HxLxW	1561x934x780	
<b>Dry weight</b>		395	
<b>R410A refrigerant charge quantity</b>		4.5 x 2	

Note:

<sup>1</sup> Nominal heating conditions: Hot water delivery temperature 35°C; water/glycol outlet temperature -3°C; hot water return temperature 30°C; water/glycol inlet temperature 0°C.

<sup>2</sup> Includes power absorption of pump in accordance with EN14511.

<sup>3</sup> Nominal heating conditions: Hot water delivery temperature 35°C; water/glycol outlet temperature -3°C; hot water return temperature 30°C; water/glycol inlet temperature 0°C. Power 60 kW, hot water flow rate 10.3 m<sup>3</sup>/h; water/glycol flow rate 14.7 m<sup>3</sup>/h.

<sup>4</sup> The unit is for indoor installation only. Do not install outdoors.



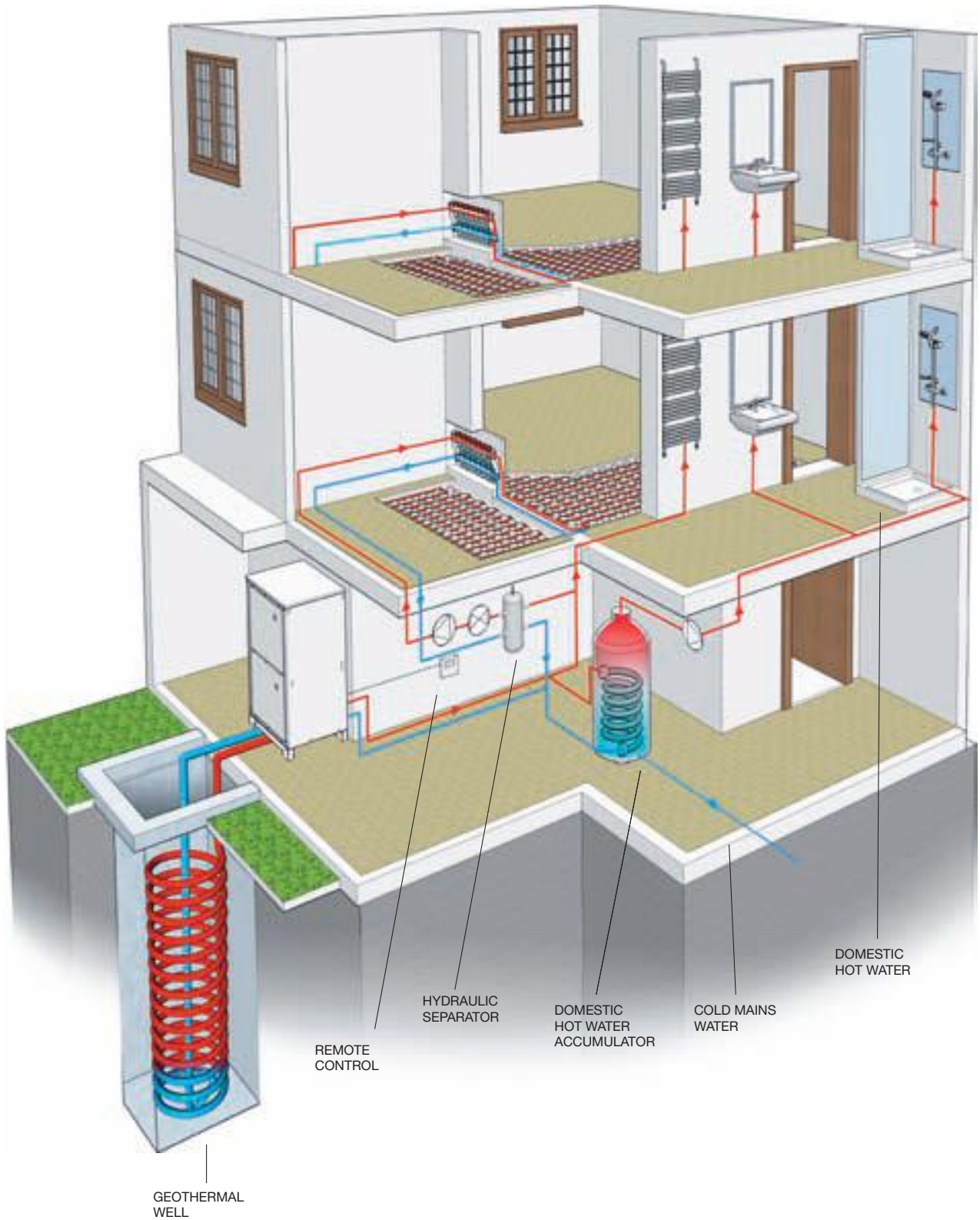

CITY MULTI

# Control systems serie

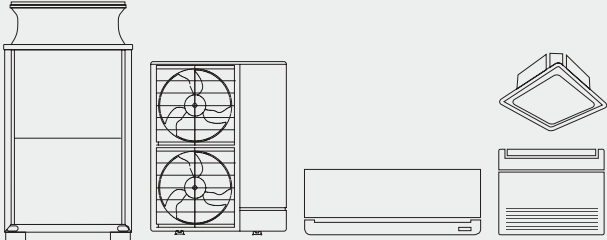

---

## INDEX

Energy saving functions .....	211
Remote controls.....	213
Centralized controls .....	217
Centralized WEB Server controls .....	218
Cloud remote control system – RMI - Remote Monitoring Interface .....	222
Supervision systems .....	225
Integration of external signals.....	227
B.M.S. Integration .....	228

DESIGN REMOTE CONTROL

PAC-YT52CRA



DELUXE REMOTE CONTROL

PAR-31MAA



ADVANCED REMOTE CONTROL

PAR-U02MEDA

NEW



WIRELESS REMOTE CONTROL

PAR-FL32MA



ECODAN REMOTE CONTROL

PAR-W21MAA



LOSSNAY REMOTE CONTROL

PZ-61DR

NEW



ON/OFF CENTRALIZED CONTROL

PAC-YT40ANRA



SYSTEM CENTRALIZED CONTROL

AT-50B



WEB SERVER CENTRALIZED CONTROL

AE-200E  
3D TOUCH Controller

NEW



WEB SERVER CENTRALIZED CONTROL

EW-50  
3D BLIND Controller

NEW



ENERGY MONITORING CLOUD SYSTEM

RMI  
Remote Monitoring Interface



SUPERVISOR SYSTEM

TG-2000A



INTEGRATION OF EXTERNAL SIGNALS

M-NET-AHC-24VDC



B.M.S. INTEGRATION

INTERFACE  
B.M.S.



# Energy Saving Functions

## Dual Set Point

The new Dual Setpoint function makes it possible to preset setpoint temperatures for cooling and heating mode in a single operation.

On Y series heat pump models, this functions means that it is no longer necessary to reset setpoint temperatures each time the operating mode of the unit is switched from Heating to Cooling mode and vice versa.

In R2 heat recovery systems, it is also possible to set an “energy

saving” temperature band for AUTO mode, within which the system ventilates only and performs no thermal air treatment (thermo off).

Setting a broader band increases energy savings, but permits larger temperature variations in the indoor space. Setting the two setpoint temperatures closer together creates a narrower thermo off band, prioritising maximum comfort in the indoor space over energy savings.

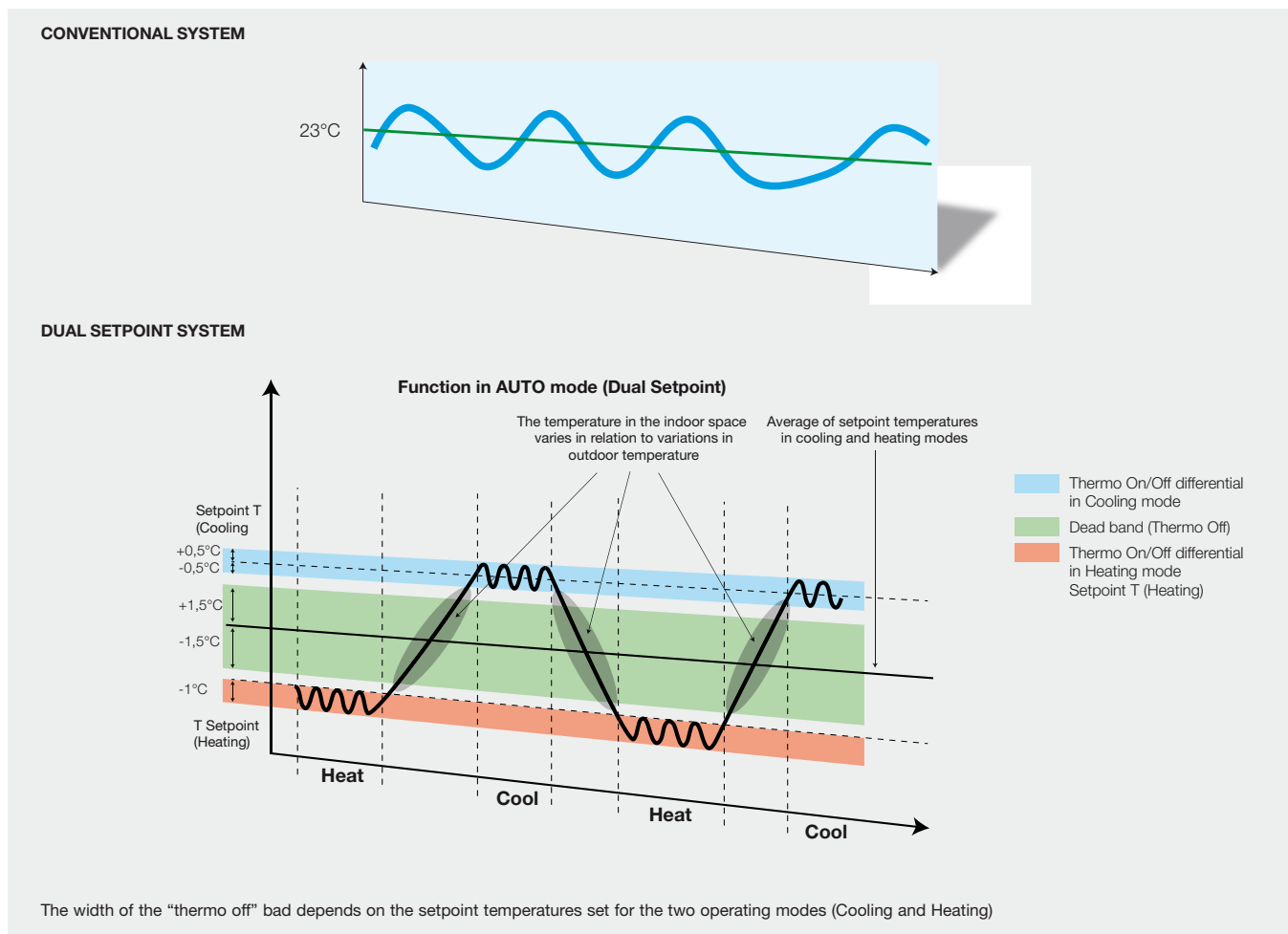

# Energy Saving Functions

## View and set setpoint temperatures in 0.5°C increments



The goal of Mitsubishi Electric is to offer a better quality of life through innovative products. Mitsubishi Electric was the first manufacturer to introduce the capability of viewing and setting setpoint temperatures in 0.5°C increments, for unparalleled comfort calibrated with decimal precision by the user.

This function gives the user a greater sense of control and, therefore, comfort, by offering a wider and more precise choice of settable temperatures.

## Downloadable consumption data via internet

With the 3D TOUCH and BLIND Controller centralised WEB Server controllers, consumption data can be downloaded directly from the internet. These centralised controllers are equipped with 2Gb SD internal memory cards, making it possible to store up to two years of operating data for the system and consumption data for all the users in the conditioning system. This data is downloadable in CSV format from a dedicated web page, while activating the “AE-200 Charge” and “EB-50 Charge” PIN code licenses adds functions to proportionally calculate individual electric power and energy consumption for air conditioning, heating and domestic hot water utility usage.

## RMI Ready

The VRF CITY MULTI system must be equipped with a WEB Server centralised controller to be able to interface with the RMI remote management, supervision and energy monitoring platform. The 3D TOUCH and BLIND Controller WEB Server centralised controllers are RMI Ready and already support all the functions of the RMI system.

Previous generation Web Server centralised controllers are also RMI Ready, but only allow remote management of the installation (RMI Smart).



# Remote controls

## PAC-YT52CRA Design remote control

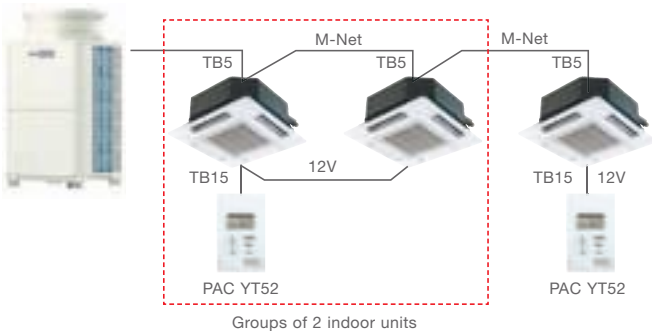

- Display with white backlighting.
- Simple wall-mounted installation.
- Easy and intuitive with icon-based interface.
- Operating mode selection function.
- Vane position selection function (for compatible indoor units).
- Usable to manage 1 group of up to 16 indoor units.
- Simple connection with single non-polarised two-core wire.
- **MA** self-addressing technology.
- Suitable for all types of indoor unit.
- Recommended for hotels and public spaces, as ambient air temperature display can be disabled.
- Integrated temperature sensor usable instead of indoor unit sensor.
- Configurable temperature range settable from local keypad.

## PAR-31MAA Deluxe remote control unit

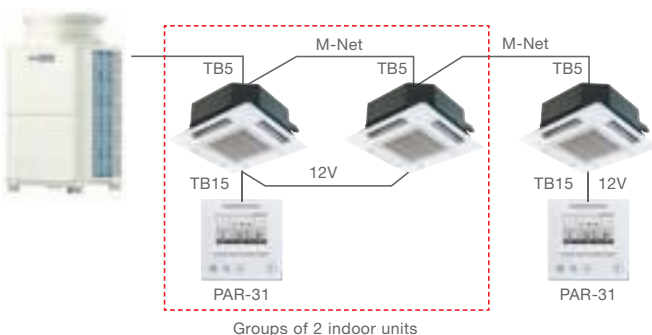

- Display with white backlighting and adjustable contrast.
- Simple wall-mounted installation.
- Night Set-back function for setting minimum winter temperature or maximum summer temperature in temperature maintenance mode.
- Effective static overpressure selection function for ducted indoor units (PEFY-P VMHS only).
- Internal weekly timer function and simplified internal timers (Auto-off, etc.).
- Usable to manage 1 group of up to 16 indoor units.
- Easy and intuitive, with icon based graphic interface, direct control buttons and function buttons.
- Simple connection with single non-polarised two-core wire.
- **MA** self-addressing technology.
- Suitable for all types of indoor unit, including GUF.
- Recommended for groups with only one indoor unit.
- Integrated temperature sensor usable instead of indoor unit sensor.
- Configurable temperature range settable from local keypad.
- **View and set setpoint temperatures in 0.5°C increments.**

## PAR-U02MEDA Advanced remote control

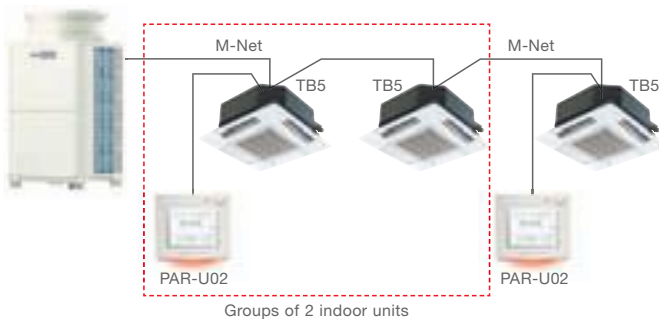

The Mitsubishi Electric Advanced remote control may be used to control up to 16 indoor units. While advanced, this controller also offers basic functions such as monitoring and controlling the status of the units in the system, and a weekly hour timer. Four integrated sensors (temperature, humidity, occupancy and light) allow a series of advanced adjustment and control functions. For example, the occupancy sensor can be used to save energy by configuring different modes based on the occupied/vacant status of each room.

- Large monochrome LCD touch screen display with white backlighting.
- Usable to manage 1 group of up to 16 indoor units.
- **Integrated temperature, humidity, occupancy and light sensors.**
- SMART energy saving and comfort functions.
- Contextual colour LED indicating operating status of indoor units.
- **View and set setpoint temperatures in 0.5°C increments**
- **Dual Setpoint** function.
- Internal weekly timer.
- **ME M-Net** addressing technology.
- Extended setting ranges for setpoints (Cool: 19-35°C; Heat: 5-28°C).
- New functions for use in conjunction with AHC Programmable Controller (PLC M-Net), for creating operating strategies with generic devices.

## Occupancy Sensor

The occupancy sensor detects if a room is vacant and enables automatic control of the indoor units to implement energy saving strategies based on the effective occupancy of each room. The occupancy sensor enables the following energy saving functions:

- Switch indoor units ON/OFF based on occupied/vacant state of room;
- Fan speed control;
- Switch indoor unit from Thermo ON to Thermo OFF state;
- Configure temperature deviation based on occupied/vacant status.

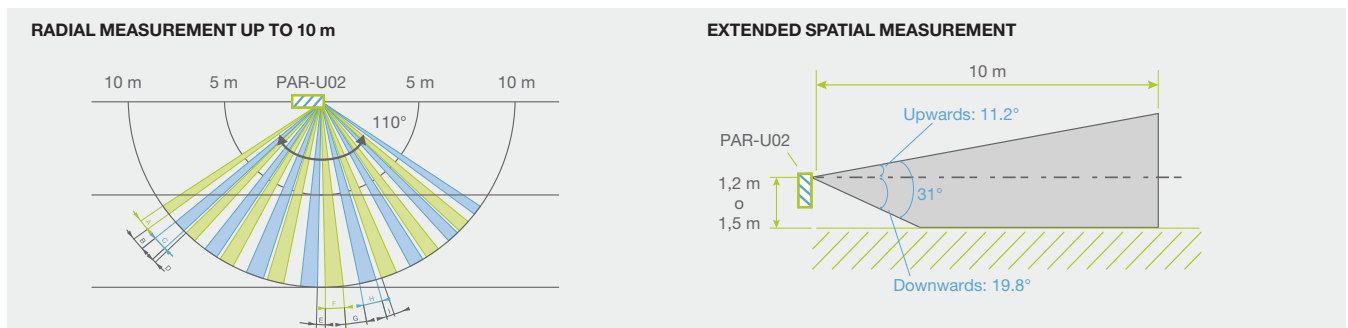

## Light Sensor

The light sensor measures the light levels in the conditioned room and adjusts the brightness of the remote control display accordingly.

Bright/dark thresholds may be set directly from the remote control over an extended luminosity range (1 to 65535 lx).

The light sensor is also used in low light conditions to confirm the occupied/vacant status of the room.

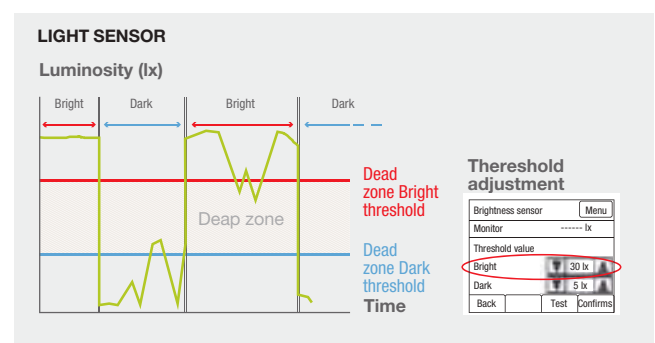



## Temperature and Humidity Sensor

The integrated temperature and humidity sensor may be used to increase perceived comfort levels, while the ability to adjust the temperature with a precision of 0.5°C gives the user an even greater sense of control. The relative humidity sensor, combined with the ability to interlock the remote control with a programmable AHC controller, makes it possible to control humidity with external devices connected to the system via the AHC.

## LED status indicator

The LED status indicator indicates the status of active functions on the remote control. Each colour is associated with a status or function:

e.g. Red=Heating, Blue=Cooling etc.

The LED indicator may be temporarily or permanently disabled.



## PAR-FL32MA wireless remote controller



- Usable to manage 1 group of up to 16 indoor units.
- Easy and intuitive with icon-based interface.
- Receiver connected simply with single non-polarised two-core wire.
- **MA** self-addressing technology.
- Suitable for all types of indoor unit.
- Recommended for groups with only one indoor unit.
- Generic receiver for all indoor unit types: PAR-FA32MA.
- Specific corner receiver for 4-way PLFY-P VBM-E cassette units: PAR-SA9FA.

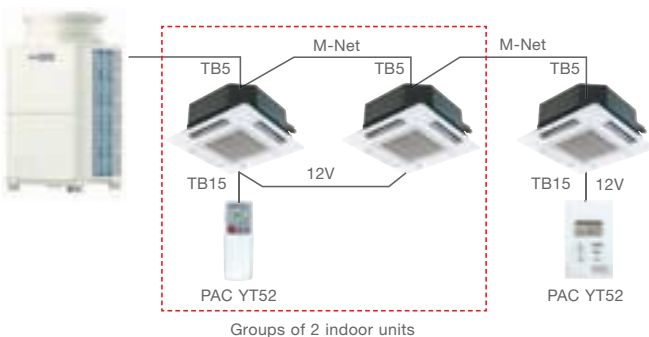

## PAR-W21MAA remote control for hydronic modules and HWHP units



- Remote control for hydronic modules, HWS and ATW units and Hot Water Heat Pump package systems (HWHP).
- Usable to manage 1 group of up to 16 indoor units.
- Easy and intuitive with icon-based interface.
- Simple connection with single non-polarised two-core wire.
- MA self-addressing technology.
- Operating mode selection (Heating, Heating ECO, Hot water, etc.).
- Internal weekly timer.
- Customisable water temperature ranges for switching operating mode from local keypad.
- On-display service messages.

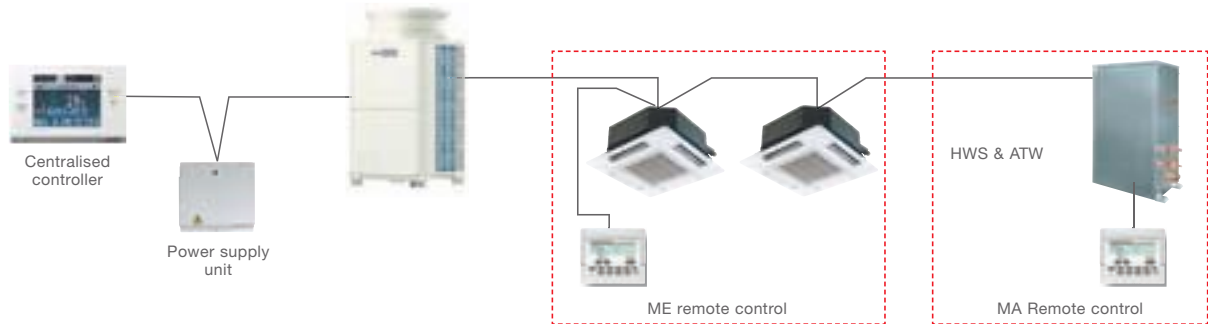

## PZ-61DR remote control for Lossnay



- Specific remote control for Lossnay heat recovery units.
- Usable to manage one group of up to 15 Lossnay units.
- Easy and intuitive with icon-based interface.
- Simple connection with single non-polarised two-core wire.
- Internal weekly timer.
- Custom ventilation strategies for mode switching (Auto/recovery/bypass).
- Night purge function for active night-time ventilation in summer.
- On-display service messages.
- Backlit LCD screen.
- Energy management.

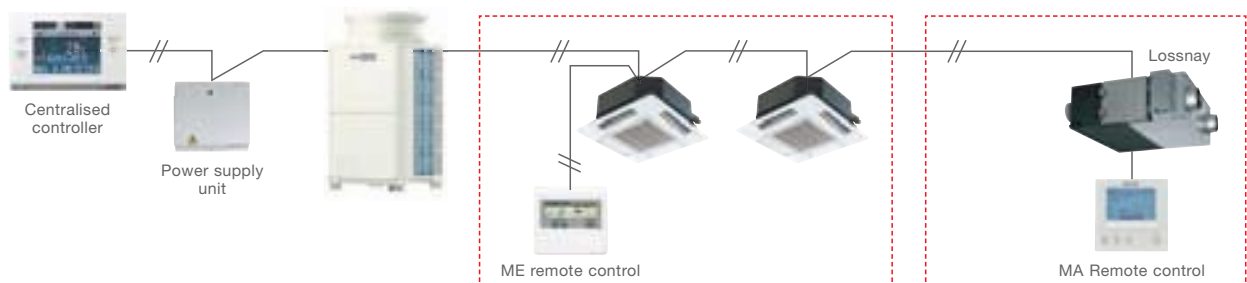

# Centralised controllers

## PAC-YT40ANRA centralised ON/OFF controller



- Usable to manage 16 groups for a total of up to 50 indoor units.
- Individual or collective group control.
- Simple and intuitive.
- Simple connection with single non-polarised two-core wire.
- **ME** M-Net addressing technology.
- Group configuration from keypad.
- External power supply is necessary for controlling more than one system.
- Must always be used in combination with remote or centralised controllers.

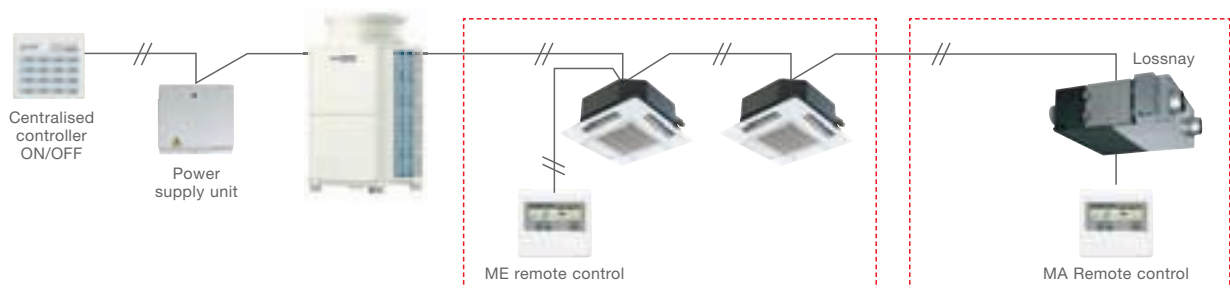

## AT-50B centralised system controller



- **5" backlit LCD touch screen.**
- Usable to manage 50 groups of up to 50 indoor units.
- Individual or collective group control, with groups displayed in grid, list or group format.
- **Dual-Setpoint** function.
- **View and set setpoint temperatures in 0.5°C increments.**
- Two weekly timers (for seasonal switching) and one daily timer.
- Simple connection with single non-polarised two-core wire.
- ME M-Net addressing technology.
- Two function buttons programmable to access any of a choice of functions (Night Set-back, weekly hour timer setting, switch operating mode, adjustable temperature range restriction, local restrictions).
- Recommended for controlling a single system.

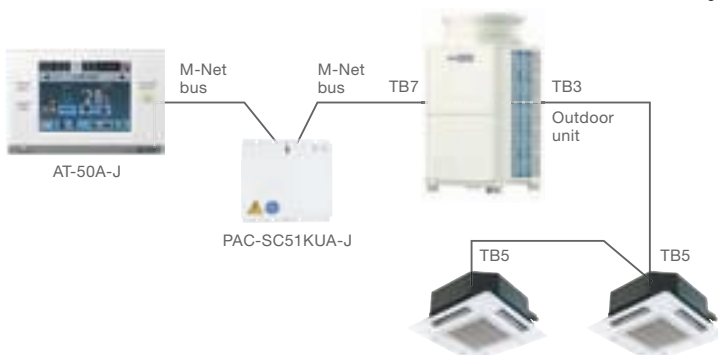

# Centralised controllers WEB Server

## AE-200 3D TOUCH Controller WEB Server centralised controller



- Generously sized backlit 10.4" SVGA touch screen with graphic layout display function.
- Built-in 240 V AC 50 / 60 Hz power supply.
- Standalone configuration: management of up to 50 indoor units.
- Extended configuration: management of up to 200 indoor units (with 3 expansion controllers EW-50).

- Individual or collective control of groups, blocks or zones.
- Ethernet interface for connection to BMS supervisor systems.
- Integrated WEB server software for management using Internet Explorer®.
- Integrated 2 GB SD memory card for storing system data.
- Direct management of 4 impulse meters with no external interface.
- Power consumption data for billing downloadable via internet connection.
- **RMI READY** Complete support for all advanced RMI platform functions for energy consumption monitoring and for multi-installation and multi-user management.
- Temperature setpoints settable and viewable with a precision of 0.5°C.
- Energy saving functions: Maintenance temperature, Sliding temperature, Optimised start, Dual Setpoint.
- M-Net interfacing with Ecodan package Hot Water Heat Pump systems (CAHV and CRHV).

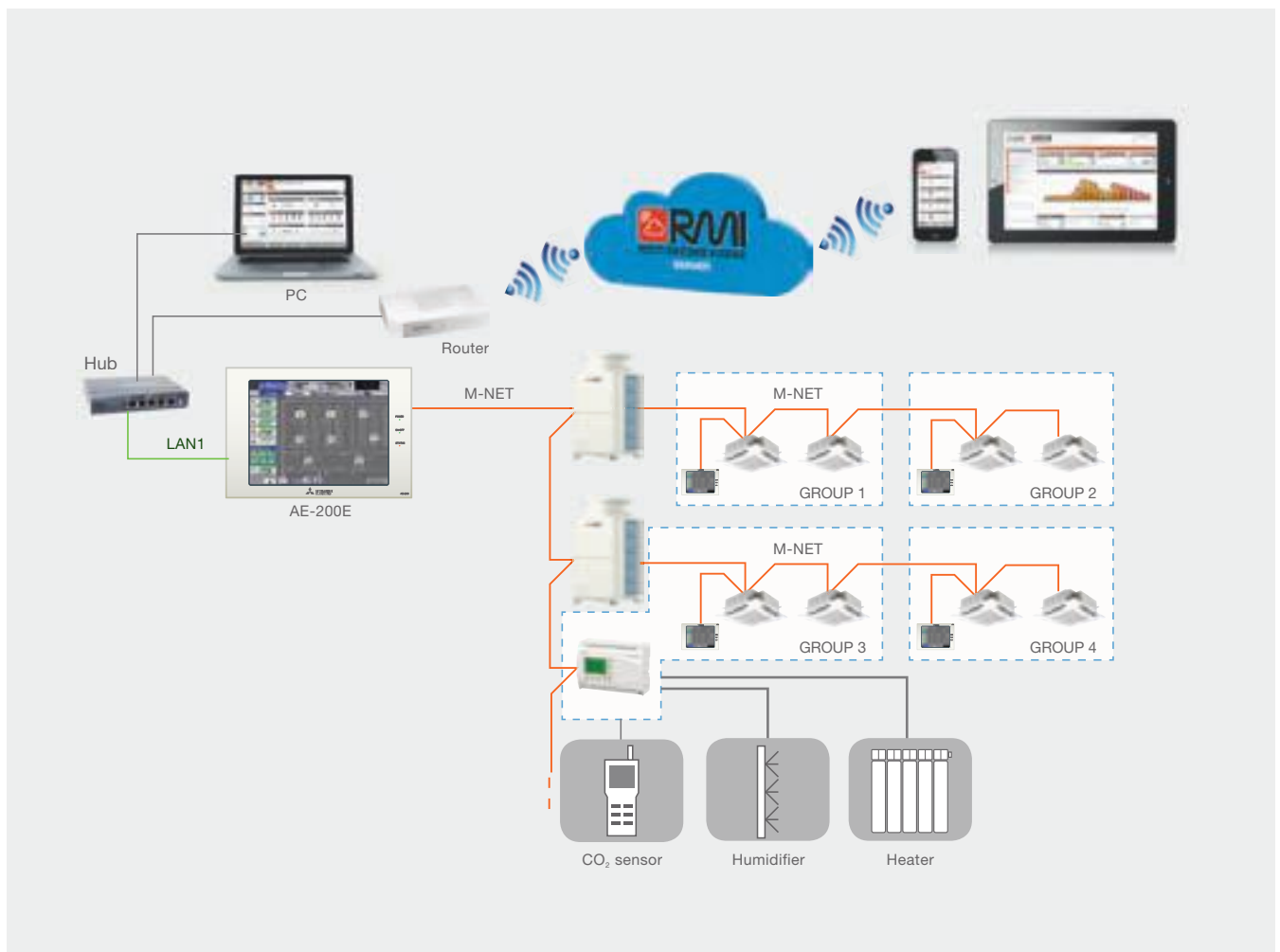

### Power and flexibility in a compact device

While measuring practically the same as the previous AG-150, the new 3D TOUCH Controller WEB Server centralised controller offers a larger screen area, greater processing power and expandable flexibility for future applications.

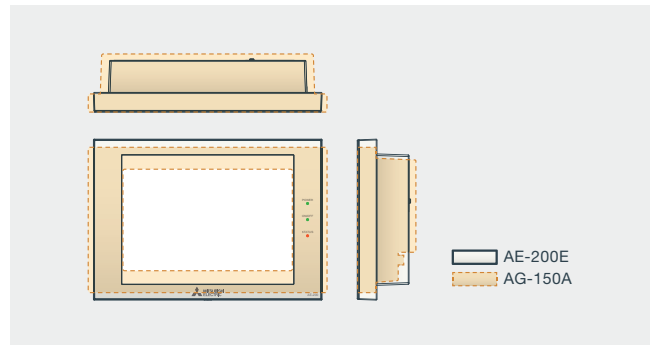

### Superior management, functional and monitoring capabilities with new Mitsubishi Electric controller systems

The 3D TOUCH Controller supports the management, operational and monitoring capabilities of all the new functions offered by the new ADVANCED remote control.

Information concerning occupancy, light levels, relative humidity in the indoor space and dual setpoints is accessible directly from the display and via the WEB.



### RMI Ready

The 3D TOUCH Controller WEB Server centralised controller performs the crucial role of acquiring and monitoring data via the M-Net data transmission bus linking all the components of the VRF CITY MULTI, Mr. Slim or Residential system.

A router (available as wired ADSL or 3G Mobile versions) creates a secure, protected communication channel with the RMI Server. The modular flexibility of the RMI Server makes it possible to store enormous volumes of data, which is acquired, processed and archived for access from portable devices.

This infrastructural complexity, combined with superior processing, management and security capabilities, is encapsulated in an extremely user friendly concept, to help users optimise the energy usage of their systems.



# Centralised controllers WEB Server

## EW-50 3D BLIND Controller WEB Server centralised controller



- “Black Box” version (no display).
- Compact dimensions (external 230V AC power supply).
- Usable to manage 50 groups for a total of up to 50 indoor units.
- Individual or collective group control.
- Ethernet interface for connection to supervisor systems.
- Integrated WEB server software for management using Internet Explorer®.
- Simplified connection, with single non-polarised two-core wire, using ME technology.
- Integrated 2 GB SD memory card for storing system data.
- Direct management of 4 impulse meters with no external interface.
- Status indicator LED indicating data transmission status and/or errors.
- Consumption data for billing downloadable via internet connection.
- A wide choice of energy saving functions offered as standard, with additional optional functions accessible with PIN code licenses.
- **RMI READY** Complete support for all advanced RMI platform functions for energy consumption monitoring and for multi-installation and multi-user management.
- Expansion controller for AE-200.

### TYPICAL CONNECTION LAYOUT

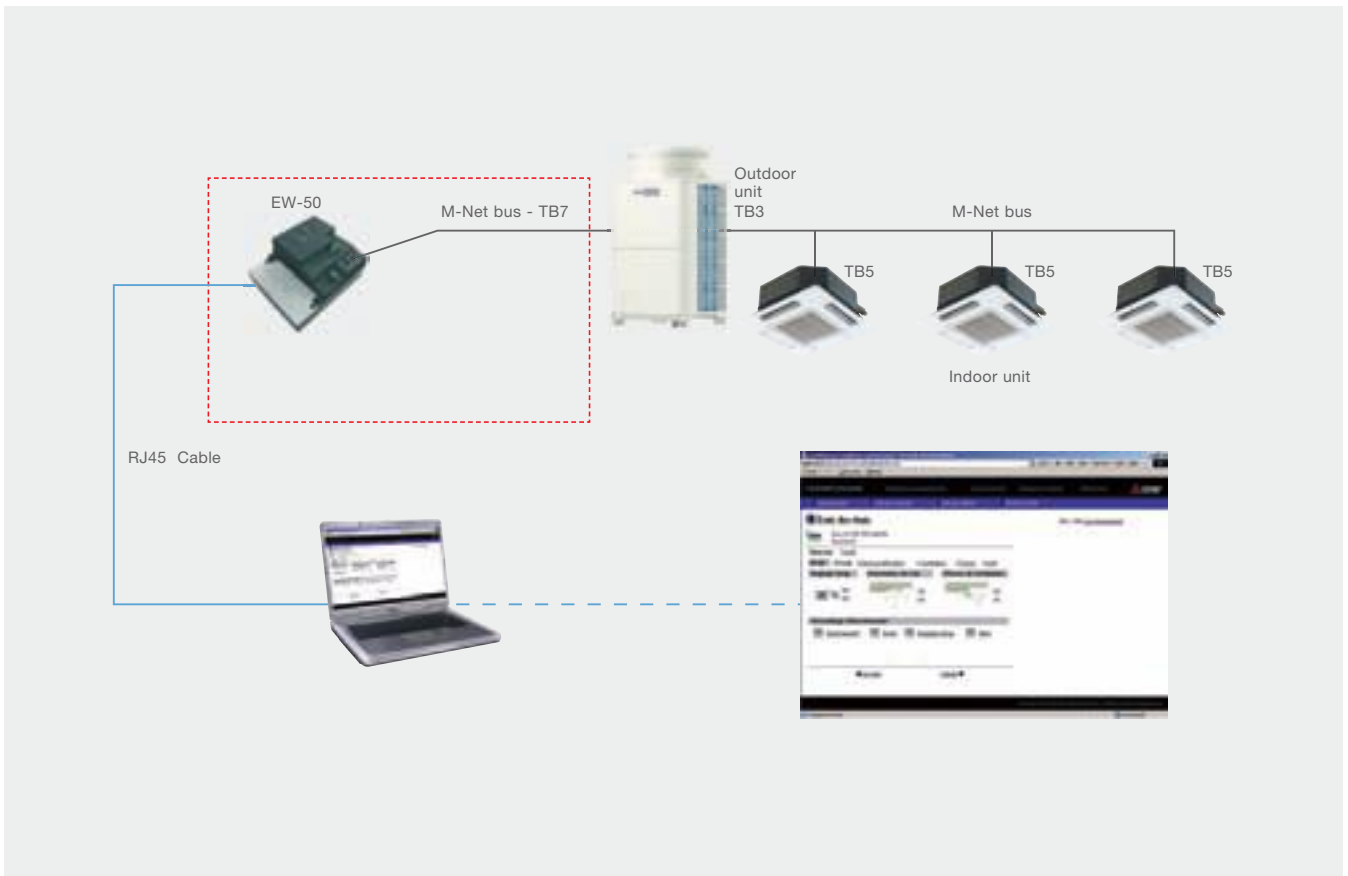

## Consumption metering and apportioning system

### “Charge” system for WEB Server centralised controllers.

The Charge consumption monitoring and apportioning system may be used to meter the consumption of electric power, thermal power and water for air conditioning, air and/or water heating and domestic hot water production with a Mitsubishi Electric VRF CITY MULTI system, and calculate individual usage values.

The AE-200 and EW-50 CHARGE systems use proprietary Mitsubishi Electric calculation and apportioning methods. This consumption apportioning method indicates the consumption

parameters of each user as percentages of the total consumption of the system. Consumption values, as percentages and kWh, may be calculated separately for:

- Outdoor Units
- Indoor Units
- Ecodan HWS Hydronic Modules
- Ecodan ATW Hydronic Modules

### TYPICAL CONNECTION LAYOUT

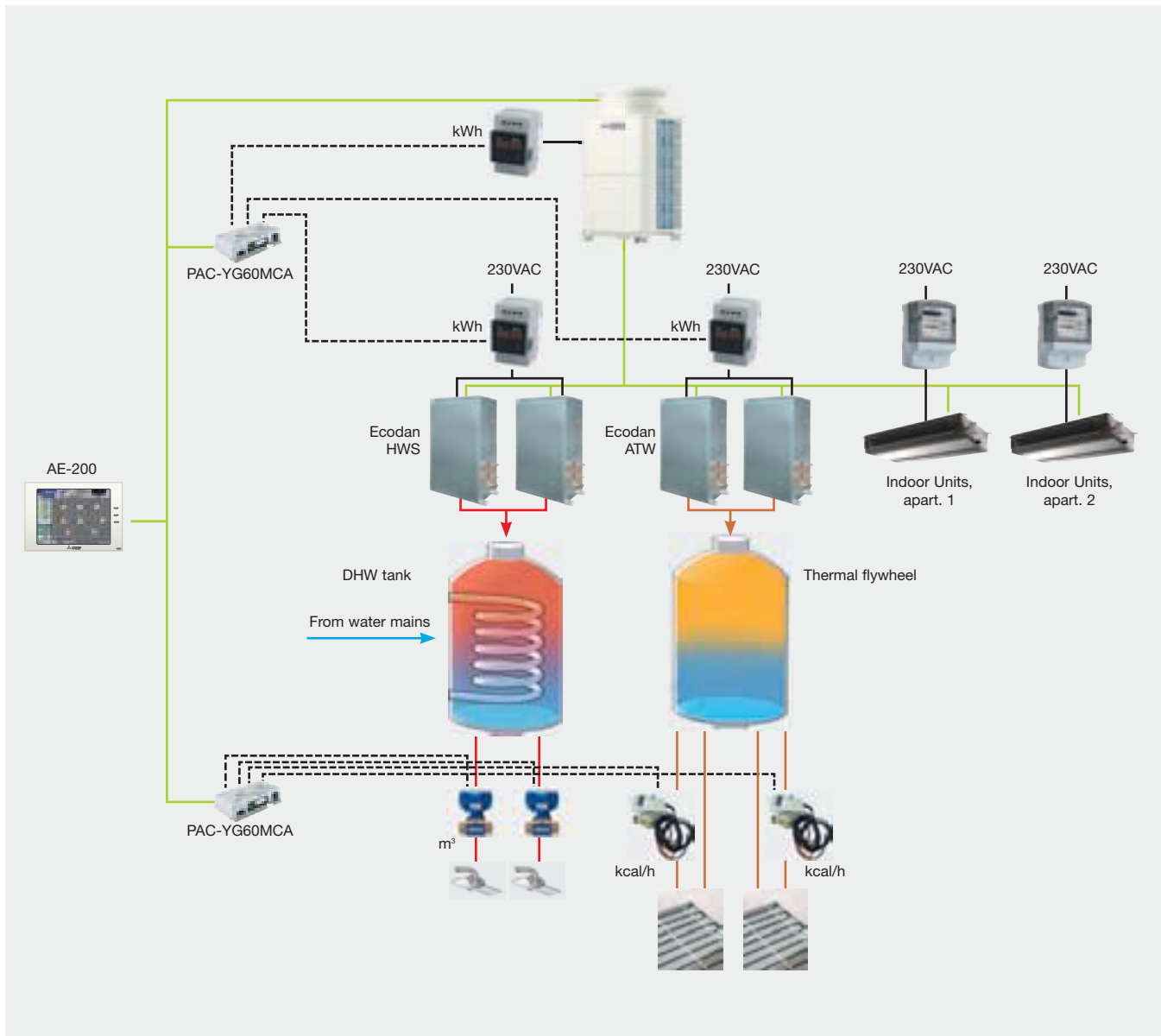

# Cloud based remote management system RMI – Remote Monitoring Interface

## The Cloud system by Mitsubishi Electric for large installations

The RMI system lets you control your air conditioning, heating and domestic hot water production system remotely from a smartphone, tablet or PC. The system may be used to monitor the performance of your appliances, programme functions, check consumption and view operating states to optimise the efficiency of the system.



## Your perfect climate in an App!

Control your air conditioner, adjust temperature and air flow settings, view and manage hot and cold water production status and check for system faults.

## Simplified control for all of your systems

Set weekly programmes and special events, and view and analyse the operating parameters of your system remotely from a mobile device with a graphic interface that lets you change settings instantaneously when needed.





## Manage your systems with detailed information and analytical functions

Manage multiple installations with different sizes and architectures conveniently from the application on your PC, view function parameters in a summarised dashboard interface, and analyse specifically created reports to make your installation work even more efficiently.

RMI is also the ideal solution for the centralised management and supervision of multiple installations in different locations.



## Who can use RMI?

Because of its many different functions, the RMI system is suitable for all types of installation, from centralised residential systems to commercial applications and large scale installations.

The remote management and monitoring functions are intended for end users (e.g. tenants), owners, administrators, energy/building managers, global service providers and installing and maintenance technicians.

## The project

The RMI project is the result of a forward thinking idea by Mitsubishi Electric to offer its customers the capability of managing their installations from portable devices, adding a significant new advantage offered by these systems. The all-new **RMI** system is the **FIRST** system of its kind based on **Cloud Computing** technology, which lets you interface with your system via a simple yet secure internet connection. RMI makes it possible to manage Mitsubishi Electric air conditioning solutions, with **energy consumption monitoring and maintenance functions**, from **smartphone** and **tablet** apps for the **iOS** and **Android** operating systems, and via a private **WEB Client** area **from a PC**. The RMI system is based on a dedicated infrastructure (RMI Server), which may be described as a container for installation data that is collected and made accessible **simply and intuitively**, and filtered and represented appropriately for the type of user analysing and using the data.

The project was designed from the start with security in mind, to protect the installation and the client against unauthorised access with a secure VPN connection (Virtual Private Network).



# Cloud based remote management system

RMI – Remote Monitoring Interface

## System architecture

The 3D TOUCH Controller WEB Server centralised controller performs the crucial role of acquiring and monitoring data via the M-Net data transmission bus linking all the components of the VRF CITY MULTI, Mr. Slim or Residential system.

A router (available as wired ADSL or 3G Mobile versions) creates a secure, protected communication channel with the RMI Server. The modular flexibility of the RMI Server makes it possible to store enormous volumes of data, which is acquired, processed and archived for access from portable devices. This infrastructural complexity, combined with superior processing, management and security capabilities, is encapsulated in an extremely user friendly concept, to help users optimise the energy usage of their systems.

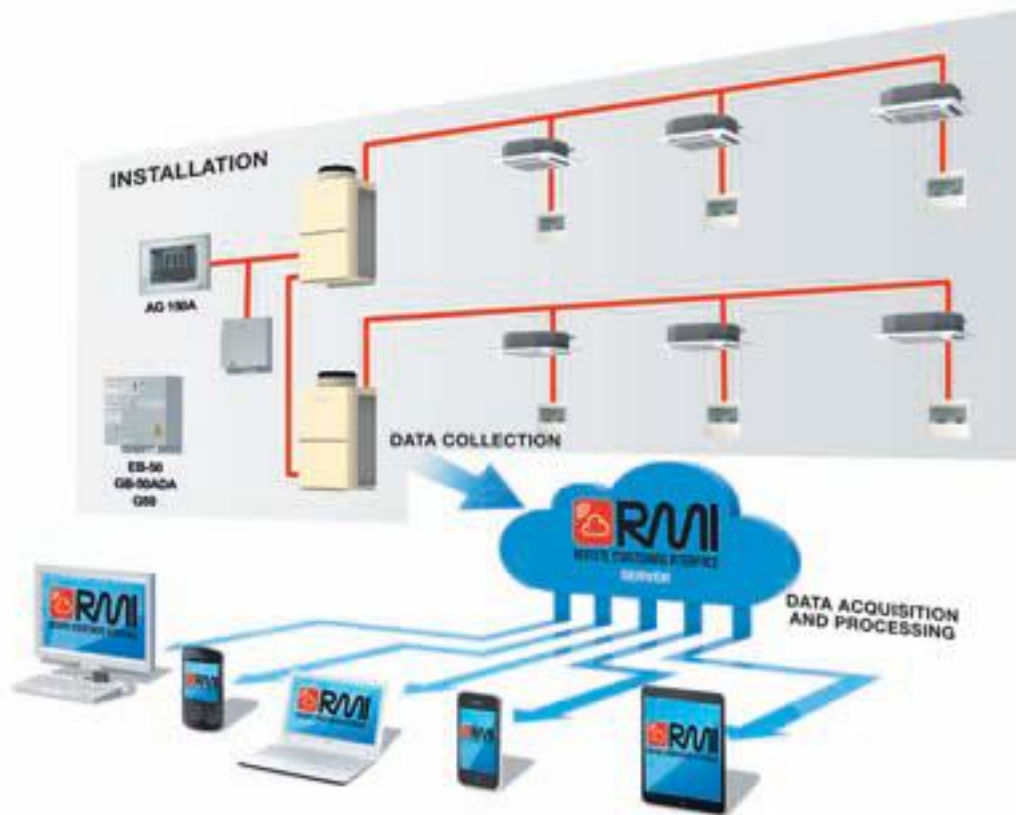

## RMI Service packages

RMI can also be applied to an existing VRF CITY MULTI system, by interfacing through the installation's existing WEB Server centralised controllers. Contact head office to check compatibility between hardware and available functions

See DEMO RMI at:

<http://rmidemo.mitsubishielectric.it>

RMI IS AVAILABLE IN THE FOLLOWING PACKAGES

 **RMI SMART**  
REMOTE MONITORING INTERFACE

 **RMI ADVANCE**  
REMOTE MONITORING INTERFACE

 **RMI MULTI-TENANT**  
REMOTE MONITORING INTERFACE

# Supervisor system

## TG-2000A supervisor system

The TG-2000A supervisor system uses the digital network connectivity of the **3D TOUCH and BLIND Controller WEB Server controllers (AE-200E / EW-50)** to offer advanced system management solutions. The TG-2000A is capable of managing up to **2000 air conditioners**, with complete control over all functions. The system is based on interactive software installed on a Personal Computer running Windows. The different zones of the installation are represented as graphic layouts to allow immediate identification of the individual air conditioners. For each individual zone, these screens contain interactive icons representing the different air conditioners in the installation. Each of these icons displays information on the operating status of the relative air conditioner. The graphic interface of the software is extremely clear and intuitive.



### Adjusting air conditioner settings

Clicking the icon for an air conditioner displays a virtual control panel for the air conditioner itself, for setting the desired functions. For optimised management, different levels of the installation may be controlled collectively and simultaneously as groups. For instance, the user may choose to adjust all the air conditioners in the zone displayed, in a system block or in the entire installation in a single operation with just one click.



# Supervisor system

## TYPICAL CONNECTION LAYOUT

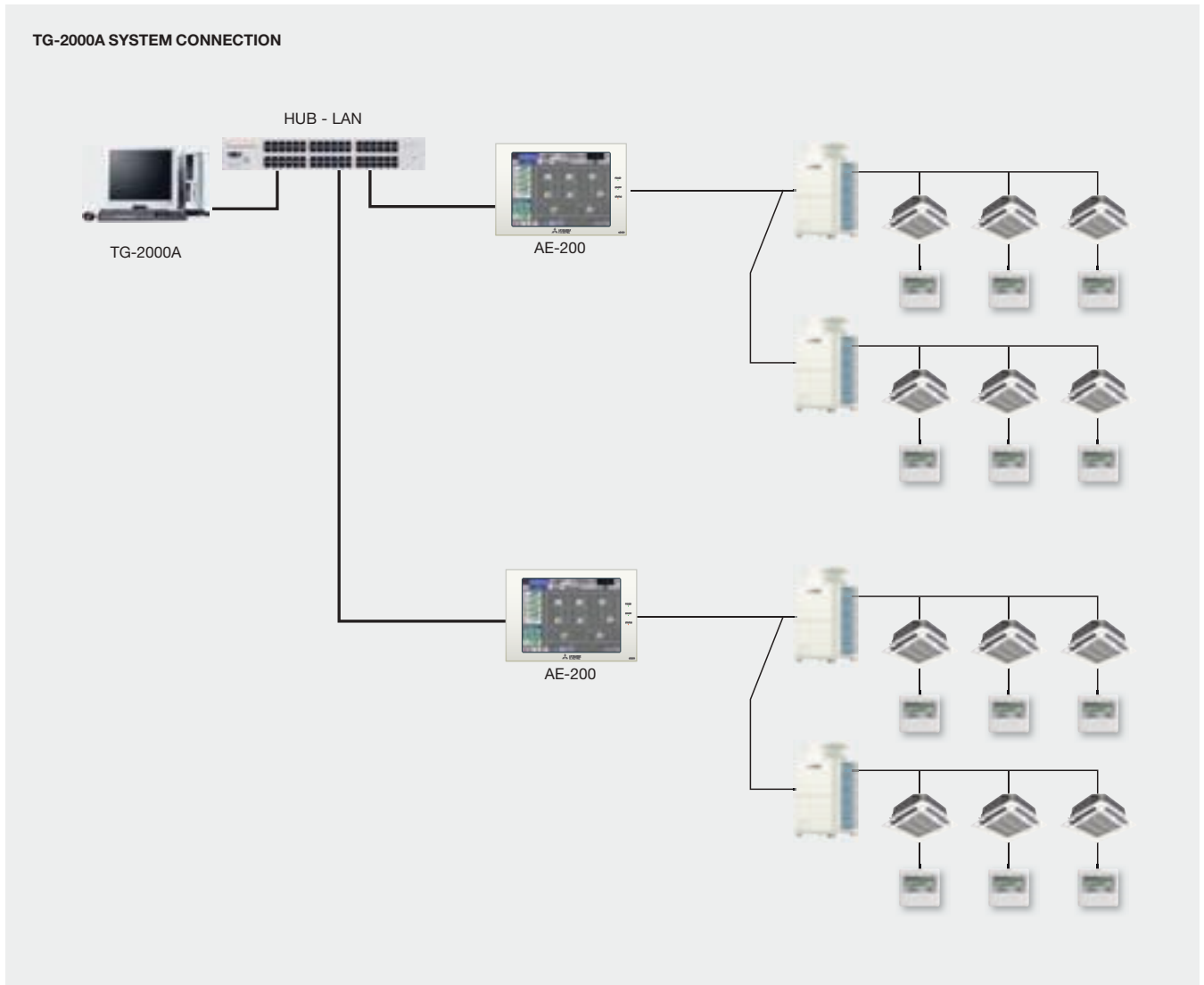

### TG-2000A Technical specifications

- TG-2000A Technical specifications
- Interactive software for Windows® OS installed on Personal Computer (not supplied by Mitsubishi Electric).
- Interactive icons for adjusting air conditioners in Autocad based graphic area.
- Usable to manage 2000 groups for a total of up to 2000 indoor units.
- Individual or collective group control.
- Group configuration.
- Easy and intuitive with graphic layouts, icon-based interface and descriptive text.
- Direct connection to WEB Server 3D centralised controllers (AE-200E/EB-50GU) via Ethernet.
- Weekly and daily timers, and annual calendar.
- Consumption monitoring and apportioning (Charge).
- Dynamic consumption control (Energy saving/Peak cut).
- Function meter.
- Graphs.
- Separate history logs for faults and normal operation.
- Individual and/or collective control.
- Auto-changeover for Y systems.
- Programmable Night mode.
- PLC management for generic appliances and energy consumption meters.
- "Wide area" geographic management for centralised supervision of multiple installations on a geographic scale.

# External signal integration

## AHC – Advanced HVAC controller



- Solution consists of an ALPHA2 PLC and an M-Net interface, both by Mitsubishi Electric.
- Intuitive object-based graphic programming function.
- Create control strategies using either physical signals (inputs and outputs) or logical signals (via M-Net data transmission bus).
- Receive signals from 2 Groups for a total of up to 32 indoor units for each PLC.
- Programme synchronised energy saving strategies between power consuming utilities (such as lighting) and the air conditioning system.
- 15 inputs and 9 outputs.
- Number of physical inputs and outputs may be increased with dedicated expansion modules.
- Large backlit LCD display for programming functions and viewing graphics, text and values.
- Direct programming with 8 function keys on front control panel without using auxiliary devices.
- Superior installation flexibility with integrated DIN rail adapter.
- System may be password-protected.

## Total integration

The AHC programmable controller uses Mitsubishi Electric know-how acquired in industrial automation applications to integrate air conditioning, heating and domestic hot water production systems with third party systems, such as access control, security, lighting control systems etc., allowing communication between the systems via the M-Net data communication bus.

This makes it possible, for example, to use data acquired via the M-Net communication bus to control external devices instead of interlocking the operation of air conditioner units and external systems connected to the AHC Programmable Controller, or using other similar measures.

## Flexible programming...

Up to 200 function blocks can be used in a single application (Set/Reset, Timer, Service messages etc.), offering extraordinary scope for controlling the entire installation.

## Extensive operating temperature range

Designed to operate in a temperature range from 25°C to 55°C and with an IP20 protection rating, these devices are ideal for both indoor and outdoor installation.

## ... and safe data!

The application is stored permanently in an EEPROM memory module. This means that active data (such as meter counts) are backed up without requiring power.

## Digital and analogue expansion modules

Dedicated expansion modules offer the possibility of increasing the number of both analogue and digital inputs and outputs.

### Digital

#### AL2-4EX:

offers 4 digital inputs

#### AL2-4EYT:

offers 4 digital outputs

### Analogue

#### AL2-2PT-ADP:

offers 2 analogue inputs

#### AL2-2DA:

offers 2 analogue outputs

# B.M.S. integration

## LMAP04 BMS interface for LonWorks® networks



The LMAP04 interface allows Mitsubishi Electric air conditioners to communicate with third party BMS supervisor and management systems through the LonWorks® network system. The hardware of the interface consists of an electronic board with software integrated in the board itself which needs no configuration.

The LMAP04 interface may be installed with any remote control or centralised controller of the Mitsubishi Electric range. The LMAP04 interface can also be used in a mixed system, which also includes the TG-2000A supervisor. Each LMAP04 interface can control up to 50 indoor units, each with its own unique address. In installations with AE-200E or EB-50GU WEB Server centralised controllers, the LMAP04 interface offers the same modularity as the controllers themselves. In these cases, a separate interface must be installed for each centralised controller.

## TYPICAL CONNECTION LAYOUT

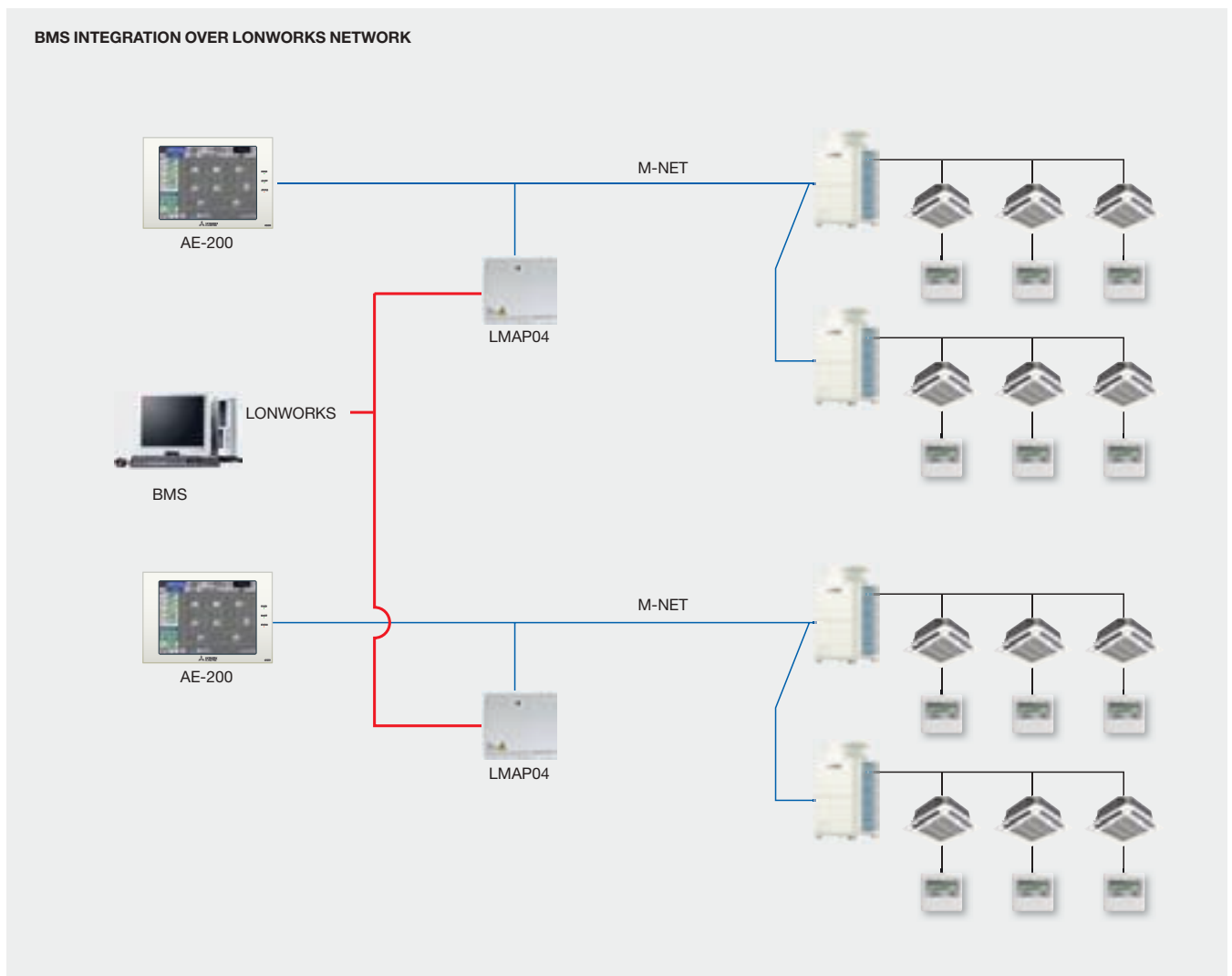

## XML BMS interface for Ethernet networks



XML is an innovative new communication system developed specifically for exchanging data over the web. XML makes it possible to create custom software extremely simply, which can even be used with a standard internet browser. The XML protocol makes it possible to integrate with a BMS system using the AE-200E or EB-50GU WEB Server centralised controllers, with no additional dedicated hardware interfaces. As all the information necessary for the BMS system is available in XML format directly over the Ethernet communication port of the AE-200E / EB-50GU controller, all that needs to be done is to connect both the AE-200E / EB-50GU WEB Server centralised controllers and the BMS computer system to the same network. Connecting to a BMS system with the XML protocol is extremely simple, as the Ethernet network platform is used. No dedicated conversion or interface hardware is needed, as shown in the typical layout schematic.

## TYPICAL CONNECTION LAYOUT

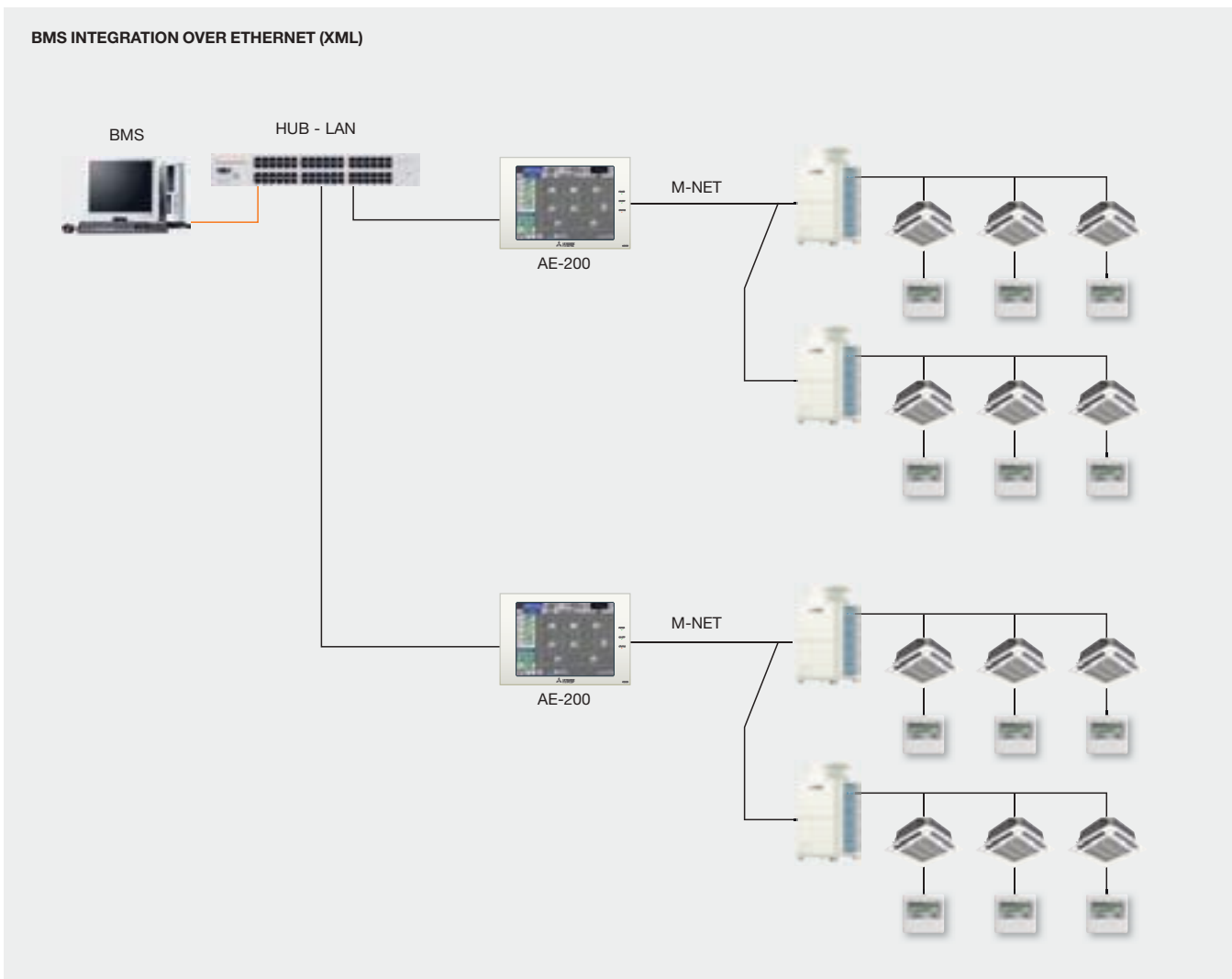

# B.M.S. integration

## BACnet® BMS interface for BACnet® networks



**BMS INTERFACES FOR THE FOLLOWING NETWORK PROTOCOLS ARE ALSO AVAILABLE:**  
- MODBUS®  
- KONNEX®

**CONTACT HEAD OFFICE FOR MORE DETAILS**

The BACnet® protocol was originally developed by ASHRAE in North America specifically for HVAC applications (Heat, Ventilation, Air Conditioning). It was subsequently also adopted in Europe as one of the standard communication solutions for air conditioning systems, together with LonWorks® and other protocols. One of the greatest advantages of this protocol is the extraordinary degree of cross-compatibility it offers, allowing systems from different manufacturers to be integrated with each other. The capabilities of the BACnet® protocol make it the ideal system for large installations and for complex, multi-level building management processes. Mitsubishi Electric has developed an interface allowing its air conditioners to be integrated with a BMS system with the BACnet® protocol. Each BAC-HD150 interface can control up to 50 indoor units, each with its own unique address. In installations with AE-200A / EB-50GU WEB Server centralised controllers, the BAC-HD150 interface offers the same modularity as the centralised controllers themselves.

## TYPICAL CONNECTION LAYOUT

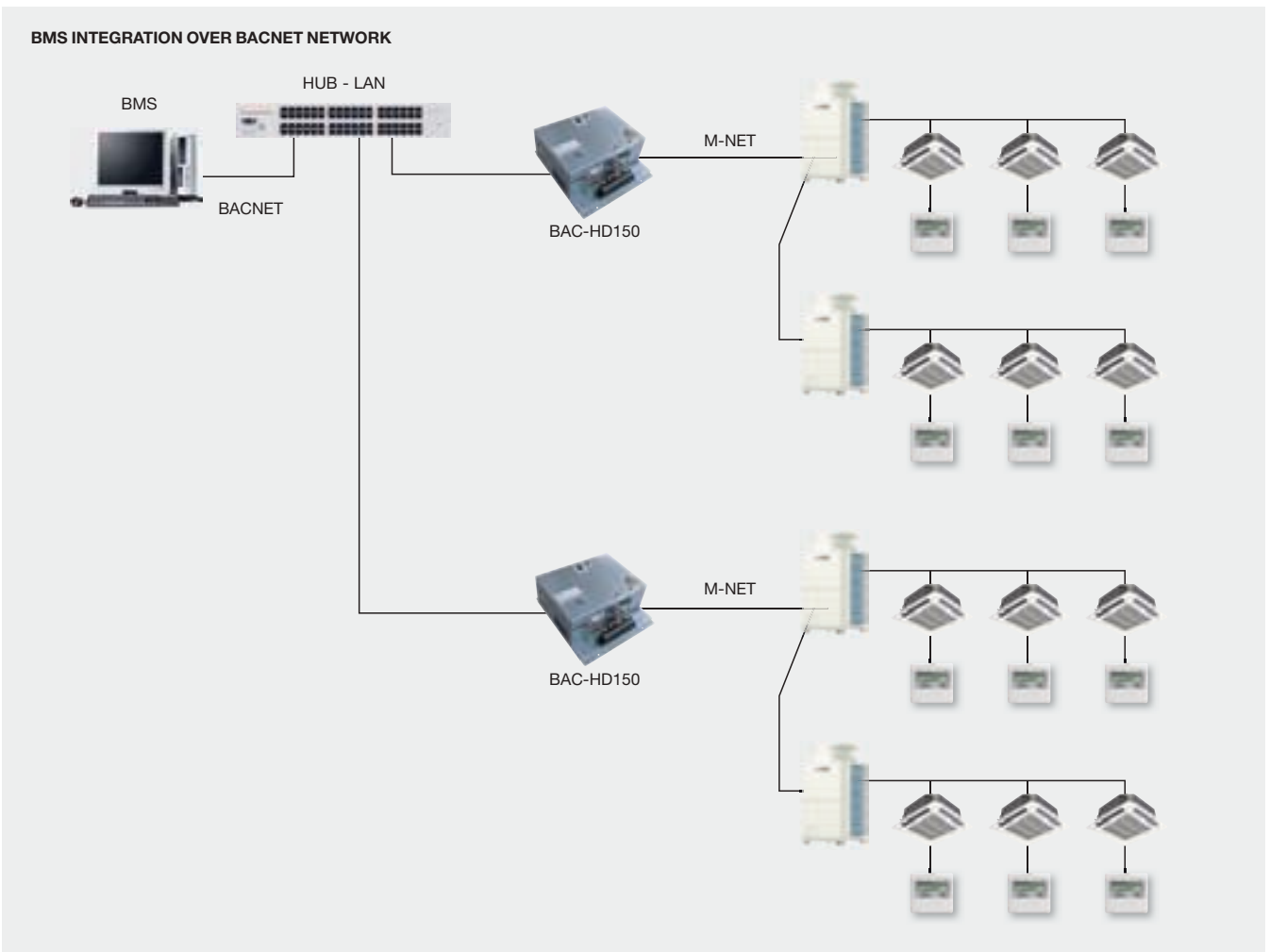



## ME-AC-MBS-100 – BMS interface for Modbus® networks



The Modbus communication protocol was initially used for PLC networks. Mitsubishi Electric offers an interface capable of controlling up to 100 indoor units (ME-AC-MBS-100) for managing a VRF CITY MULTI installation with a BMS system.

The interface is connected to the Modbus supervisor system either by an RS232/RS485 serial connection or a TCP/IP over Ethernet connection, and is connected to the Mitsubishi Electric VRF CITY MULTI installation by Ethernet.

### TYPICAL CONNECTION LAYOUT

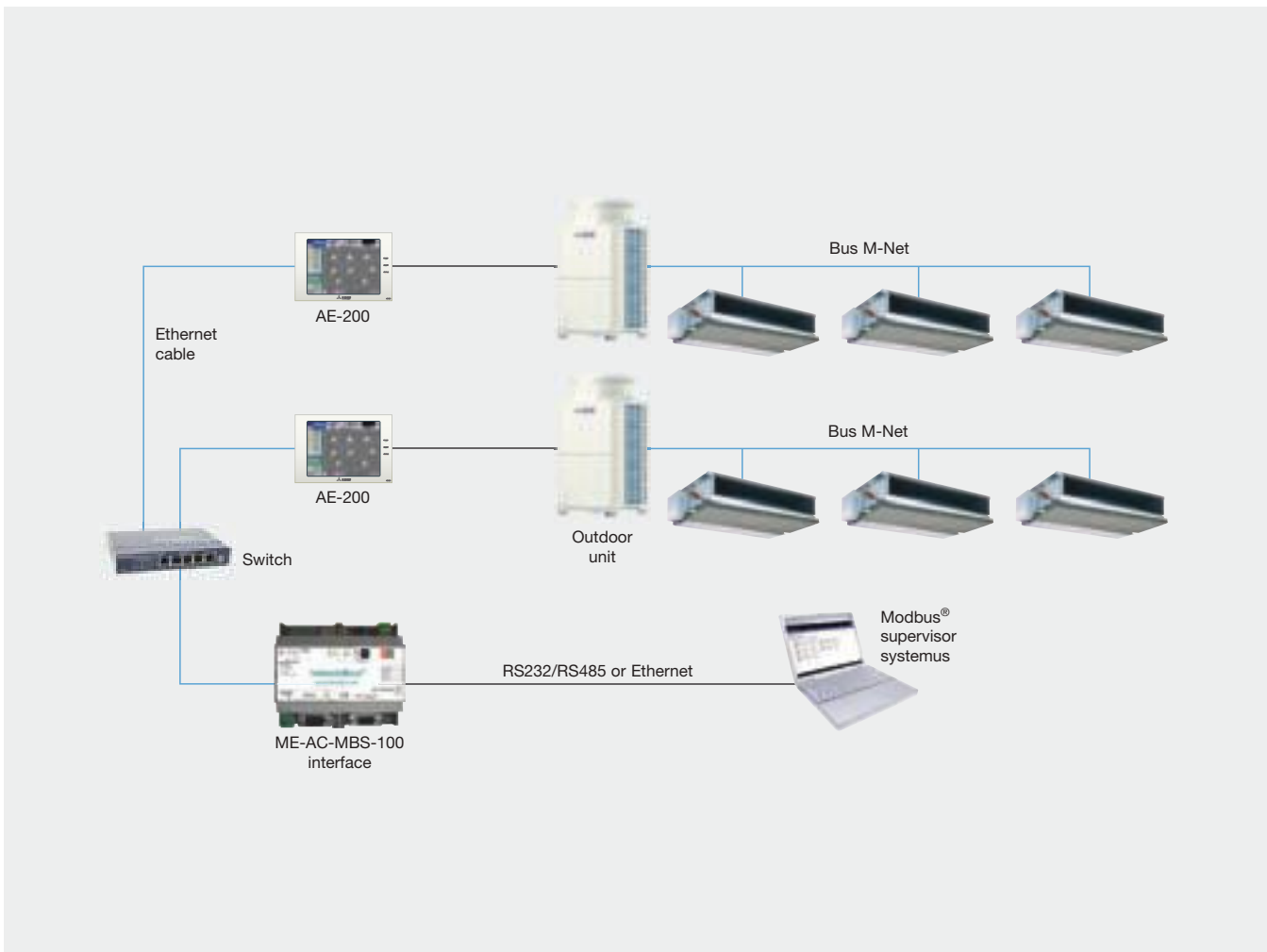

# B.M.S. integration

## ME-AC-KNX-100 – BMS interface for KNX® networks



KNX is one of the global standards for automated household and building control. This open protocol ensures cross-compatibility between products from different manufacturers.

Mitsubishi Electric offers an interface capable of controlling up to 100 indoor units (ME AC KNX – 100) for managing a VRF CITY MULTI installation with a BMS system.

The interface is connected directly to the EIB bus linked to the KNX network, and to the Mitsubishi Electric VRF CITY MULTI installation by Ethernet.

## TYPICAL CONNECTION LAYOUT

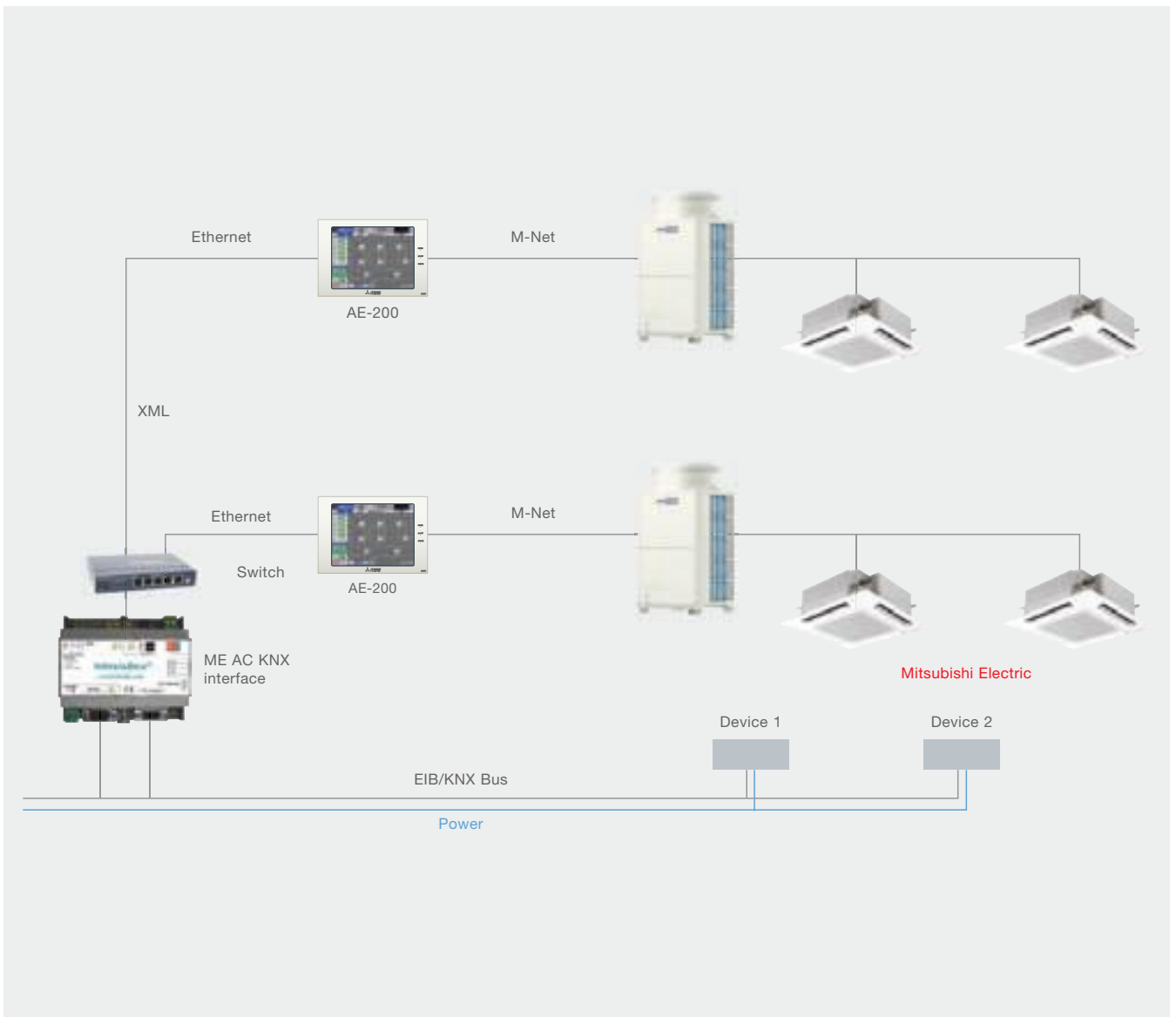









LIVING ENVIRONMENTAL SYSTEMS

Centro Direzionale Colleoni  
Viale Colleoni, 7 - Palazzo Sirio  
20864 Agrate Brianza (MB)  
tel. 039.60531 - fax 039.6053348  
e-mail: clima@it.mee.com



[climatizzazione.mitsubishielectric.it/en/prodotti/](http://climatizzazione.mitsubishielectric.it/en/prodotti/)



**for a greener tomorrow**

Eco Changes is the Mitsubishi Electric Group's environmental statement, and expresses the Group's stance on environmental management. Through a wide range of businesses, we are helping contribute to the realization of a sustainable society.



The equipments described in this catalogue contain fluorinated gasses such as HFC-410A, HFC-134A and HFC-407C. Installation of those equipment must be executed by professional installer based on EU reg. 842/2006 and 303/2008.



**CITY MULTI**  
**FULL PRODUCT LINEUP CATALOGUE 2015-2016**  
**E-1509205 (13990)**

Specifications are subject to change without notice



E-1509205